

NOVEMBER · 1948

electronics

A M c G R A W - H I L L P U B L I C A T I O N

MERCHANT-MARINE RADAR



FOR COMPACT HIGH FIDELITY EQUIPMENT

Ultra compact, lightweight, these UTC audio units are ideal for remote control amplifier and similar small equipment. New design methods provide high fidelity in all individual units, the frequency response being ± 2 DB from 30 to 20,000 cycles. There is no need to resonate one unit in an amplifier to compensate for the drop of another unit. All units, except those carrying DC in Primary, employ a true hum balancing coil structure which, combined with a high conductivity outer case, effects good inductive shielding. Maximum operating level +10 DB. Weight—5½ ounces. Dimensions—1½" wide x 1½" deep x 2" high.

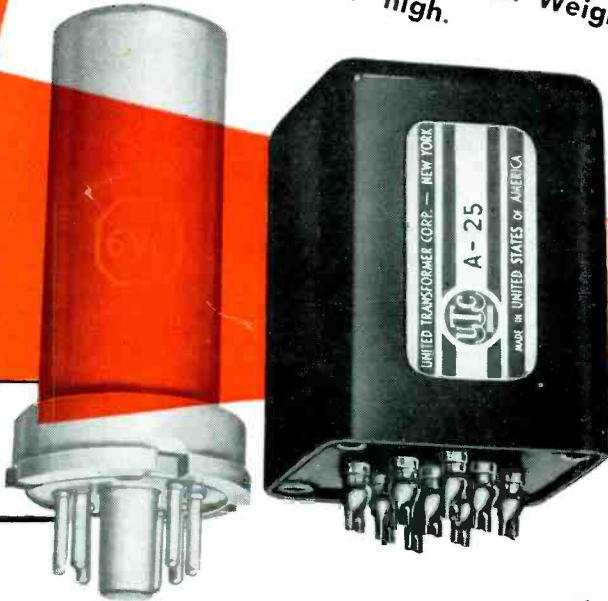

Unit shown is actual size. 6V6 tube shown for comparison only.

FOR IMMEDIATE DELIVERY

From Your Distributor

ULTRA COMPACT HIGH FIDELITY AUDIO UNITS

Type No.	Application	Primary Impedance	Secondary Impedance	± 2 DB from	List Price
A-10	Low impedance mike, pickup, or multiple line to grid	50, 125, 200, 250, 333, 500 ohms	50,000 ohms	30-20,000	\$15.00
A-11	Low impedance mike, pickup, or line to 1 or 2 grids	50, 200, 500 ohms	50,000 ohms	50-10,000 multiple alloy shield for extremely low hum pickup	16.00
A-12	Low impedance mike, pickup, or multiple line to push pull grids	50, 125, 200, 250, 333, 500 ohms	80,000 ohms overall in two sections	30-20,000	15.00
A-18	Single plate to two grids	8,000 to 15,000 ohms	80,000 ohms overall, 2.3:1 turn ratio overall	30-20,000	14.00
A-24	Single plate to multiple line	8,000 to 15,000 ohms	50, 125, 200, 250, 333, 500 ohms	30-20,000	15.00
A-25	Single plate to multiple line 8 MA unbalanced D.C.	8,000 to 15,000 ohms	50, 125, 200, 250, 333, 500 ohms	50-12,000	14.00
A-26	Push pull low level plates to multiple line	8,000 to 15,000 ohms each side	50, 125, 200, 250, 333, 500 ohms	30-20,000	15.00
A-30	Audio choke, 300 henrys @ 2 MA with no D.C. 450 henrys @ 2 MA 6000 ohms D.C., 75 henrys @ 4 MA 1500 ohms D.C., inductance				10.00

The above listing includes only a few of the many Ultra Compact Audio Units available . . . write for more details.

United Transformer Co.

NEW YORK 13, N. Y.
 150 VARICK STREET
 EXPORT DIVISION 13 EAST 40TH STREET, NEW YORK 16, N. Y.
 CABLES: "ARLAB"

electronics

A MCGRAW-HILL
PUBLICATION



NOVEMBER • 1948

MERCHANT-MARINE RADAR		Cover
Equipment such as this, made by the Sperry Gyroscope Company, assures safe, continuous operation of ships		
THE PROSPECTS FOR UHF TELEVISION		68
JTAC report to FCC reveals problems, suggests program		
INTERNATIONAL BROADCASTING, by John H. Battison		70
Review of world-wide practices indicates growth potential in many countries outside of North America		
ULTRASONIC THICKNESS INDICATOR, by Benson Carlin		76
Lightweight instrument with cathode-ray display is used for production checking of hollow or laminated items		
HERMETICALLY SEALED COMPONENTS, by W. J. Leiss, G. R. Moltrup, J. H. Slaton and A. H. Waynick		80
Sealed plug-in components provide humidity and moisture protection		
ROAD-TESTING GASOLINE, by R. R. Proctor		83
Tubes provide instrumentation for rating automotive fuels over the entire speed range		
COMPOSITE AMPLITUDE AND PHASE MODULATION, by Oswald G. Villard, Jr.		86
Transmission similar to single-sideband is obtained by using a-m and p-m simultaneously		
REGULATOR FOR 400-CYCLE INVERTER, by Carl A. Helber		90
Good regulation is provided by a simple two-tube circuit		
SONIC NAVIGATION SYSTEM, by Stanley R. Rich and A. H. Rosen		92
Coincident reception of two different audio signals from underwater transmitters guides ships through channel		
LOW-DISTORTION CROSSOVER NETWORK, by Paul W. Klipsch		98
Analysis shows that proper location of network reduces distortion and permits use of ordinary transformers		
LIGHT-FLASH GENERATOR, by R. G. Roush and Ferdinand Hamburger, Jr.		100
Twin-source device provides continuously variable flash repetition rate and duration		
MOBILE SELECTIVE CALLING, by E. H. B. Bartelink		103
New inexpensive decoder for dialling radiotelephone subscribers		
MICROPHONE CALIBRATOR, by D. H. Bastin		106
Sound-pulsing technique permits recording sensitivity and frequency response without anechoic chamber		
DESIGN OF A NAVAL COMMUNICATION STATION, by David Baker		110
Unit designed for future expansion employs several new architectural and structural ideas		
STABILIZING SERVOMECHANISMS, by Donald McDonald		112
Straightforward laboratory method for determining constants of compensating network for servomechanisms		
F-M AND TELEVISION RECEIVING ANTENNAS, by George P. Kearse		118
Tabulation of characteristics of six types, with plain and folded dipole versions of each		
BUSINESS BRIEFS	64	
CROSSTALK	67	
TUBES AT WORK	120	
ELECTRON ART	124	
NEW PRODUCTS	128	
NEWS OF THE INDUSTRY	132	
		NEW BOOKS BACKTALK INDEX TO ADVERTISERS

DONALD G. FINK, *Editor*; W. W. MacDONALD, *Managing Editor*; John Markus, Vin Zeluff, Frank H. Rockett, A. A. McKenzie, *Associate Editors*; William P. O'Brien, *Assistant Editor*; Hal Adams, *Editorial Assistant*; Gladys T. Montgomery, *Washington Editor*; Harry Phillips, *Art Director*; Eleanor Luke, *Art Assistant*; R. S. Quint, *Directory Manager*; John Chapman, *World News Director*; Dexter Keezer, *Director Economics Department*

KEITH HENNEY, *Consulting Editor*

H. W. MATEER, *Publisher*; WALLACE B. BLOOD, *Manager*; D. H. Miller, H. R. Denmead, Jr., *New York*; Wm. S. Hodgkinson, *New England*; F. P. Coyle, Warren W. Shew, *Philadelphia*; C. D. Wardner, *Chicago*; J. L. Phillips, *Cleveland*; J. W. Otterson, *San Francisco*; Carl W. Dyingier, *Los Angeles*; Ralph C. Maultsby, *Atlanta*; Paul West, *London, England*; J. E. Blackburn, Jr., *Director of Circulation*

Contents Copyright 1948, by McGraw-Hill Publishing Company, Inc. All Rights Reserved. MCGRAW-HILL PUBLISHING COMPANY, INCORPORATED, JAMES H. MCGRAW (1860-1948), Founder • PUBLICATION OFFICE 99-129 North Broadway, Albany 1, N. Y., U. S. A. EDITORIAL AND EXECUTIVE OFFICES, 330 West 42nd St., New York 18, N. Y., U. S. A.—Member A. B. P. Member A. B. C.

James H. McGraw, Jr., President; Curtis W. McGraw, Vice-President and Treasurer; Eugene Dufeld, Executive Assistant for Publications; Nelson Bond, Director of Advertising; James A. Gerardi, Secretary; and J. E. Blackburn, Jr., Director of Circulation.
ELECTRONICS, November, 1948, Vol. 21: No. 11. Published monthly, with an additional issue in June, price 75c a copy for U. S. and possessions, and Canada; \$1.00 for Latin America; \$1.50 for all other foreign countries. Directory issue \$2.00. Allow at least ten days for change of address. All communications about subscriptions should be addressed to the Director of Circulation. Subscription rates—United States and possessions, \$6.00 a year, \$9.00 two years, \$12.00 for three years. Canada (Canadian funds accepted), \$7.00 a year, \$11.00 for two years, \$14.00 for three years. Latin American countries \$10.00 for one year, \$16.00 for two years, \$20.00 for three years. All other countries \$15.00 for one year, \$30.00 for three years. Please indicate position and company connections on all subscription orders. Entered as Second Class matter August 29, 1936, at Post Office, Albany, New York, under the Act of March 3, 1879. BRANCH OFFICES: 520 North Michigan Avenue, Chicago 11, Ill.; 68 Post Street, San Francisco 4; Aldwych House, Aldwych, London, W.C. 2; Washington, D. C. 4; Philadelphia 3; Cleveland 15; Detroit 26; St. Louis 8; Boston 16; Atlanta 3, Ga.; 621 So. Hope St., Los Angeles 14; 738-9 Oliver Building, Pittsburgh 22. ELECTRONICS is indexed regularly in The Engineering Index.

better components build better REPUTATIONS

...specify **EL-Menco**

No product is better than its weakest component. This is why more and more manufacturers now use EL-MENCO mica capacitors. Rather than risk their reputations on inferior components they automatically specify El-Menco — the mica capacitor with the kind of performance that always gives customer satisfaction and builds better reputations.

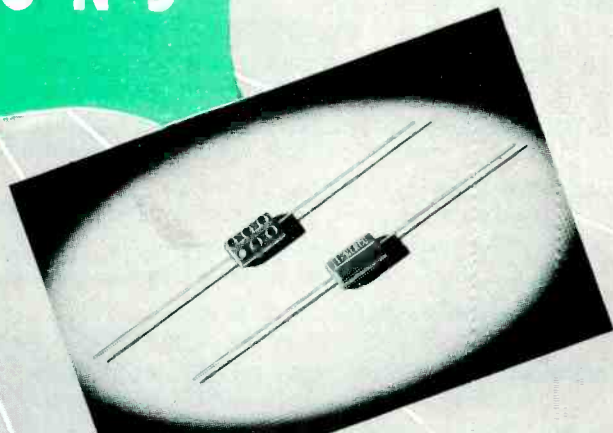

New

CM 15 MINIATURE CAPACITOR

9/32" x 1/2" x 3/16"

For Radio, Television and Other Electronic Applications

2 to 420 mmf. capacity at 500 v DCA

2 to 525 mmf. capacity at 300 v DCA

Temp. Co-efficient ± 50 parts per million per degree C for most capacity values

6-dot standard color coded

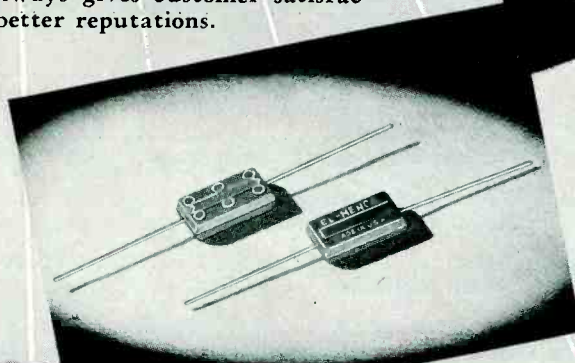

CM 2Q CAPACITOR

Available in "A", "B", "C" and "D" characteristics

2 to 1500 mmf. in tolerances down to $\pm 1\%$ * or .5 mmf. at 500 D.C. working voltage

6-dot color coded

*Whichever is greater

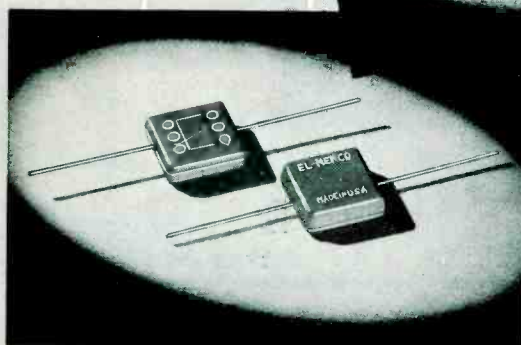

CM 35 CAPACITOR

Available in "A", "B", "C", "D" and "E" characteristics

Minimum tolerance 1%

500 D.C. working voltage

6-dot color coded

ARCO ELECTRONICS, INC.

135 Liberty St., New York, N. Y.

Sole agent for Jobbers and Distributors in U. S. and Canada

Foreign Radio and Electronic Manufacturers communicate direct with our Export Dept. at Willimantic, Conn. for information

THE ELECTRO MOTIVE MFG. CO., INC.
WILLIMANTIC CONNECTICUT

EL-Menco

CAPACITORS



Write on your firm letterhead for Catalog and Samples

MOLDED MICA

MICA TRIMMER

HELIOS new, better **BLACK** line prints

DRY DEVELOPED

• Here are positive line working prints that are amazingly clear and easy to read. Every detail on the original pencil drawing is reproduced in crisp, dense black lines that stand out in sharp contrast against the white background.

It has been the goal of K&E in developing Helios†, to bring you a better, more dependable line of dry diazo reproduction materials than had ever been made before. To achieve this, K&E established a new, modern plant for the manufacture of Helios materials exclusively. We not only make the finished products—but we manufacture, to our own exacting standards, the required color-forming components. You see the results whenever you make prints on Helios papers, cloths or films—for their consistently high quality is due to the fact that, from start to finish, Helios materials are made with the skill, care and vigilance characteristic of K&E throughout 81 years of making drafting and reproduction materials and equipment.

partners in creating

You can make positive line working prints on black line, blue line or maroon line opaque Helios papers or cloth *directly* from original drawings, layouts, letters, documents, forms. Or you can save your originals and reproduce positive line working prints *directly* from positive line intermediate originals on Helios transparent papers, cloth or films. For samples, write Keuffel & Esser Co., Hoboken, N. J., or ask your K&E Dealer or K&E Branch for a demonstration. Remember . . . you're *positive* with Helios!



Drafting,
Reproduction,
Surveying Equipment
and Materials.
Slide Rules,
Measuring Tapes.

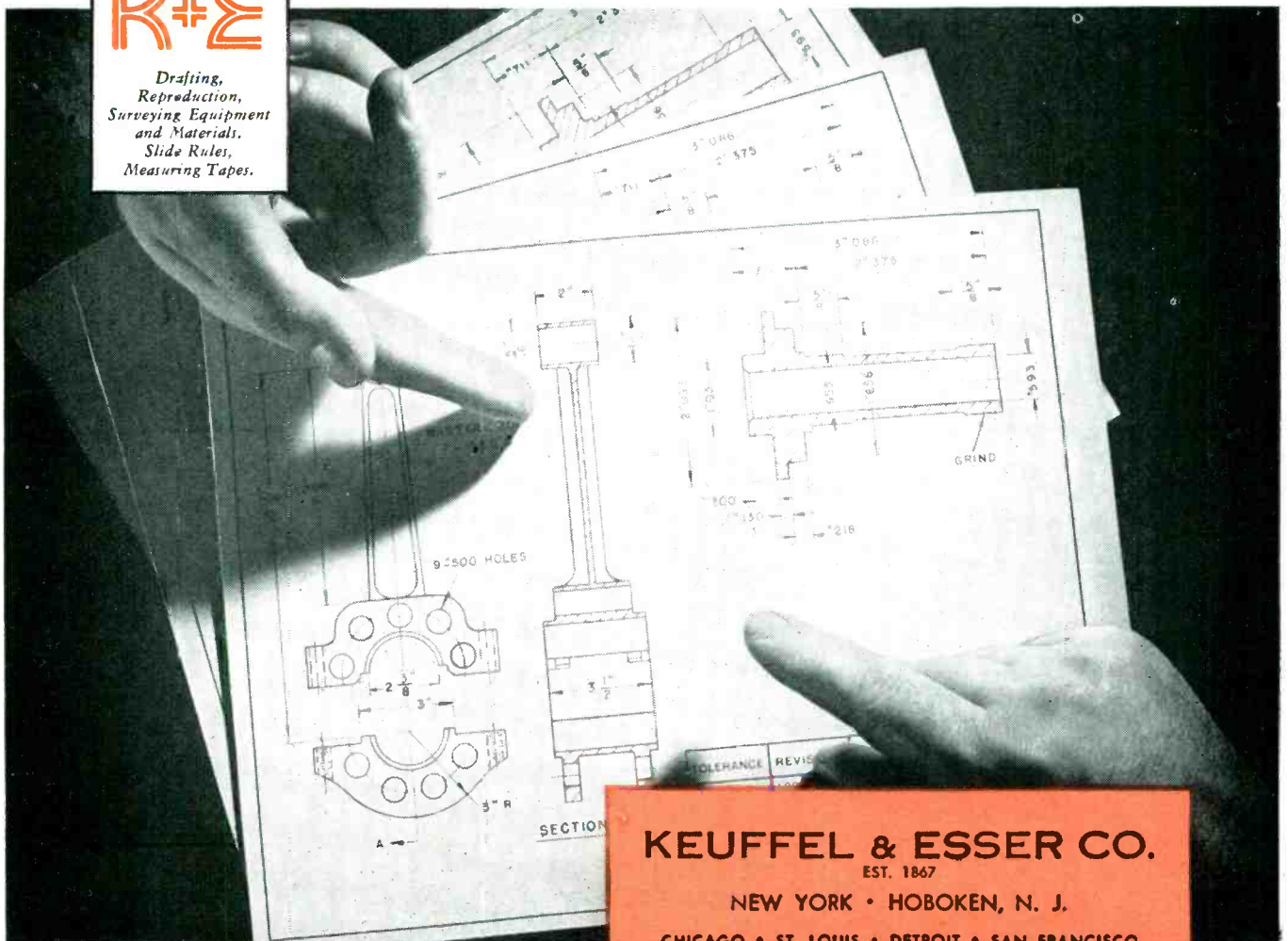

KEUFFEL & ESSER CO.

EST. 1867

NEW YORK • HOBOKEN, N. J.

CHICAGO • ST. LOUIS • DETROIT • SAN FRANCISCO
LOS ANGELES • MONTREAL

†Reg. U. S. Pat. Off.

Build quality into your wired music systems ...with these dependable components

AMPLIFIERS



The Western Electric 1140A Amplifier (at left) meets the needs of 85% of subscribers to wired music programs. Operates on a-c or d-c, delivering 10 watts from a-c source; 6 from d-c. Connects directly to telephone wires—needs no separate isolating coils.

For higher power requirements, use the 124H (at right) or the 124J, a-c amplifiers rated at 12-20 watts.

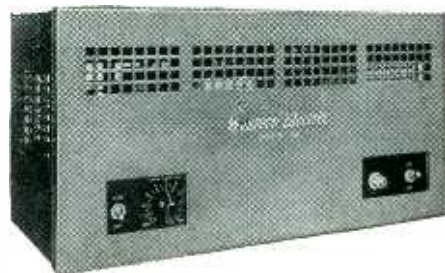

LOUDSPEAKERS



The compact 8-inch 755A direct radiator has 8-watt capacity—ample for most uses. For higher power, use the 20-watt 756A or the 30-watt 728B. All give the same high quality, the same true reproduction.



AUTOTRANSFORMERS

These units are specifically designed for easy matching of multiple loudspeakers in wired program and sound distribution systems. Three power ratings: 25A, 4 watts; 26A, 16 watts; 27A, 64 watts.

MICROPHONES

With a 633A Microphone, subscribers can use their wired music systems for announcements or paging—or can pick up programs originating on their own premises. 639 Type Cardioids also available.



EQUIPMENT FOR THE PROGRAM CENTER, TOO



109 Type Reproducer Groups are complete "packages" for use with transcription turntables. They assure top-quality reproduction of well-cut discs.

Other Western Electric equipment for the program center includes microphones, amplifiers, line coils, associated apparatus.

THE TWO major wired music program studios put the most *into* their discs with Western Electric *recording* equipment. Be sure to get the most *out* of these discs... with Western Electric *reproducing* equipment!

The completeness of Western Electric's line simplifies the planning of a peak-performance system to meet any requirements. You can get full details from your local Graybar Representative—or write Graybar Electric Company, 420 Lexington Avenue, New York 17, N. Y.

—QUALITY COUNTS—



Western Electric

DISTRIBUTORS: IN THE U.S.A.—
Graybar Electric Co. IN CANADA
AND NEWFOUNDLAND—
Northern Electric Company, Ltd.

*Meet sudden change-orders without
tying up Press Production*

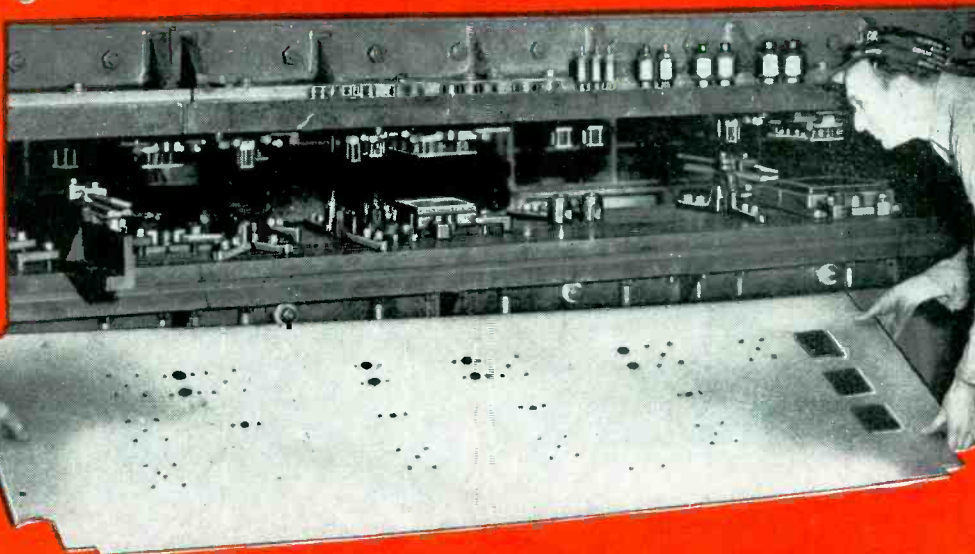
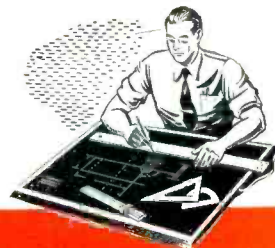

WHISTLER ADJUSTABLE PERFORATING DIES

**quickly and easily
rearranged**



Change-orders from the engineering department usually cause plenty of headaches in production... particularly where die piercing operations are involved.

But...if you're using Whistler Adjustable Dies, there is no lost time—no waiting—no extra die expense. The same dies are easy to rearrange to the new design. Add units from stock, or delete sizes and shapes no longer required. Arrange the new set-up right on the press.

Consider the savings in production time alone. Then think how continued re-use of the same dies in subsequent jobs writes off first cost.

Whistler Dies can be used in practically any press. All parts are interchangeable. Precision is assured on long or short runs. Closer centers permit fewer press operations.

Deliveries are quick... little or no waiting. Standard round punches and dies up to 3" are available from stock. Ovals, squares, rectangles and special shapes can be made up in a few days. Write for the Whistler Catalogs today and get all the facts.

S. B. WHISTLER & SONS, INC.
742 MILITARY ROAD BUFFALO 17, NEW YORK

See us at Booth 1502 National Metal Exposition
October 25 to 29—Convention Hall—Philadelphia



What's your problem?

Fine Wire?

Tungsten?

Molybdenum?

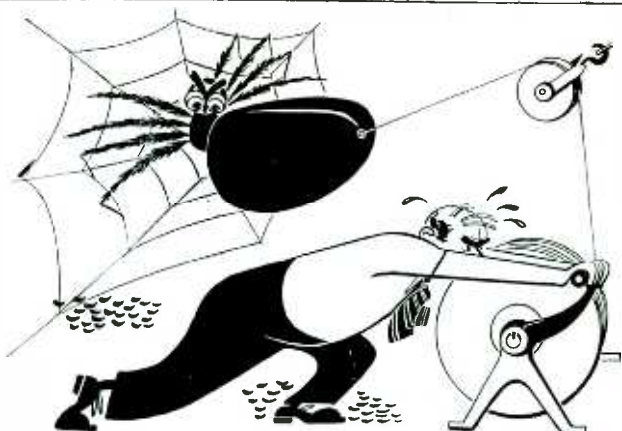

Problem 1

The firm of AL LOYS & AL UMINUM were in urgent need of fine aluminum and aluminum alloy wire for a delicate production job. Fine Wire Headquarters assured them that it was no problem at all. The order was placed, the Fine Wire delivered, and it performed to the complete satisfaction of all concerned.

Problem 2

Mr. Hi Hott needed molybdenum sheets for forming into parts. High hot strength and good ductility were required. North American Philips supplied him with Elmet Molybdenum sheets that met his specifications exactly.



Problem 3

Mr. N. O. Emission, II, required plated grid wires. He solved his problem with a call to Fine Wire Headquarters. We shipped him some gold plated tungsten and molybdenum wires. Result: no secondary emission.

the answer

WHY not call Fine Wire Headquarters when you have a question about fine wire? We can't do the impossible, but we can do lots of things that can bring you the right fine wire for the job.

So—when you have a problem on Fine Wire, Tungsten or Molybdenum—wire, phone or write to North American Philips, makers of NORELCO Fine Wires, and ELMET Tungsten and Molybdenum products.

NORTH AMERICAN PHILIPS COMPANY, INC.

Dept. XT-11, 100 East 42nd Street, New York 17, N. Y.

Export Representative • Philips Export Corporation • 100 East 42nd Street, New York 17, N. Y.

Baird
 Associates
 Incorporated
 specifies
 Sorensen
 electronic
 voltage
 regulation



Shown above is the Infrared Gas Analyzer. Baird Associates, Incorporated, manufacturers of precision optical instruments for production and research analytical control use a Sorensen Model 250 A.C. line voltage regulator with their Infrared Gas Analyzer. Only Sorensen units provide the degree of line voltage stabilization necessary to increase the sensitivity of the Analyzer readings. SIX IMPORTANT SORENSEN FEATURES: • *Precise regulation accuracy*; • *Excellent wave form*; • *Output regulation over wide input voltage range*; • *Fast recovery time*; • *Adjustable output voltage, that once set, remains constant*; • *Insensitivity to line frequency fluctuations between 50 and 60 cycles*. If you calibrate meters, need quality control on test lines, work with X-ray equipment, or are a research physicist or chemist, there is a *standard* Sorensen AC or DC unit to solve your voltage problem. The Sorensen Catalog contains complete specifications on standard Voltage Regulators and Nobatrons. *It will be sent to you upon request.*

THE FIRST LINE OF STANDARD ELECTRONIC VOLTAGE REGULATORS.

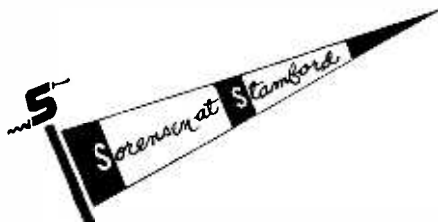

SORENSEN & Company, Inc.

Stamford, Connecticut

Represented in all principal cities.



Presents...

COMPLETE FM TEST EQUIPMENT

For Broadcast Stations

Here is a complete transmitter maintenance group — providing every measurement necessary for top-flight operation from microphone to antenna! Three fast, accurate precision instruments in one compact whole — specifically designed for years of trouble-free performance — proven in service in radio stations throughout America.

These are the *-hp-* instruments that comprise this group.

- 1. *-hp-* 335B Frequency and Modulation Meter.**
Continuous measurement of carrier frequency and modulation swing. Low distortion audio output for measuring and monitoring.
- 2. *-hp-* 206A Audio Signal Generator.**
Provides continuously variable audio frequency voltage having a total wave form distortion of less than 0.1% from 50 cps to 20 kc.
- 3. *-hp-* 330C Noise and Distortion Analyzer.**
Measures harmonic distortion and noise level from demodulated carrier or audio channels. Built-in-vacuum-tube-voltmeter measures audio level, frequency response and gain.

All instruments have identical panel sizes for convenient mounting in relay racks. Can be delivered in colors and finishes to match your equipment.

GET FULL INFORMATION...WRITE TODAY

HEWLETT-PACKARD COMPANY

1481A PAGE MILL ROAD • PALO ALTO, CALIFORNIA

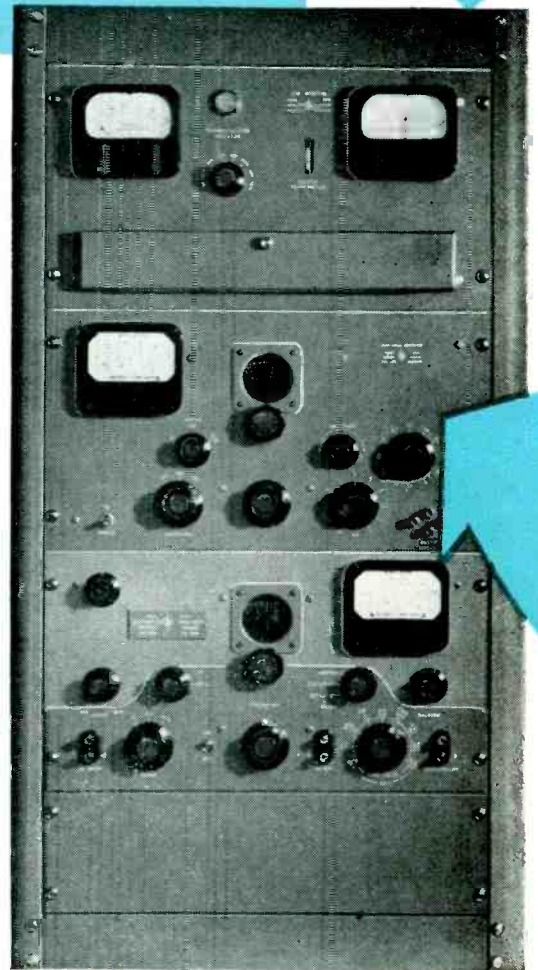

This *-hp-* Maintenance Group Makes These Essential FM BROADCAST MEASUREMENTS

Carrier Frequency: Continuously monitored with accuracy well within F.C.C. limits.

Modulation Swing: Continuously measured at instrument installation and at control console.

Modulation Limit: Alarm lamp flashes on instrument and console when pre-set level is exceeded.

Aural Monitor: Demodulated signal provides listening check for operator.

Harmonic Distortion: Measured from r-f carrier or audio channel.

Noise: Measured accurately from FM carrier or audio channel.

Frequency Response: Overall response, microphone to antenna, of individual units in transmitter set-up.

Audio Transmission: Accurately measures gain of audio channels.

Audio Level: Measured over range from +50 db to -60 db at 600 ohm level.

Equalizer Circuits: Characteristics of circuits and lines can be checked accurately, swiftly.

Oscilloscope Connections: Facilitates visual study of noise and distortion.



-hp- 335B FM Monitor

Accurate, Stable, Easy to Operate

BRIEF SPECIFICATIONS

Frequency Range: Any single frequency, 88 to 108 mc.

Deviation Range: +3 kc to -3 kc.

Accuracy: Better than ± 1000 cps.

Modulation Range: Modulation swing 100 kc. Scale calibrated 100% at 75 kc.

Audio Output: Supplied with 75 microsecond de-emphasis circuit, flat within $\frac{1}{2}$ db of standard curve, 20 cps to 20 kc.

Monitoring Output: 1 milliwatt into 600 ohms, balanced, at 100% modulation.

Size: Panel $10\frac{1}{2}$ " x 19". Depth 13".

Precision accuracy, unique stability, new convenience and compact size—those are but a few of the reasons why this -hp- 335B is the finest instrument ever developed for FM broadcast monitoring. Here are additional advantages that help make this new -hp- instrument an ideal component of the -hp- FM group.

Simple to Operate. No adjustments required during operation.

Independent of Signal Level. Readings of frequency or modulation meter are unaffected by variations in transmitter level.

Unusual Stability. Low temperature coefficient crystal in temperature-controlled oven combined with specially developed

electronic linear counter circuits provides accuracy far beyond that required. Measurements do not depend on accuracy of conventional discriminator circuits.

Remote Modulation Meter. Modulation may be monitored at control console or other remote point.

Low Distortion. Audio output for measuring purposes has less than .25% residual distortion.

Low Noise Level. Residual noise and hum in audio output are at least 75 db below 100% modulation.

Meets F.C.C. Requirements.

This instrument is small in size, easy to install, suitable for cabinet or rack panel mounting. Can be furnished to match your transmitter color scheme.



-hp- 206A Audio Signal Generator

Distortion Less Than 0.1%

BRIEF SPECIFICATIONS

Frequency Range: 20 cps to 20 kc, 3 bands.

Output: +15 dbm to matched resistive loads. 10 volts available for open circuit.

Output Impedance: 50, 150, 600 ohms center-tapped and balanced. 600 ohms single-ended.

Frequency Response: Better than 0.2 db beyond output meter at all levels.

Distortion: Less than 0.1% above 50 cps. Less than 0.25% from 20 cps to 50 cps.

Hum Level: At least 70 db below output signal, or more than 100 db below 0 level, whichever is larger.

Size: Panel $10\frac{1}{2}$ " x 19". Depth 13".

The -hp- 206A Audio Signal Generator provides a source of continuously variable audio frequency voltage having a total distortion of less than 0.1%. This feature, combined with high stability, flat frequency response, and great accuracy of output voltage, makes it an ideal component for FM station maintenance. Here are some of this instrument's unusual advantages:

Distortion less than 0.1% between 50 cps and 20 kc.

Continuously variable frequency range, covered in 3 bands, micro-controlled dial,

effective scale length 47", ball-bearing smoothness for tuning ease.

Output meter monitors output voltage signal with accuracy of at least 0.2 db.

Special low temperature co-efficient frequency determining elements provide high stability and excellent accuracy over long periods of time.

Precision attenuators vary output signal level in 0.1 db steps over 111 db range.

This new -hp- generator is convenient to use, compact in size. It can be provided for rack or cabinet mounting, in colors matching your installation.

1481

hp laboratory instruments
FOR SPEED AND ACCURACY

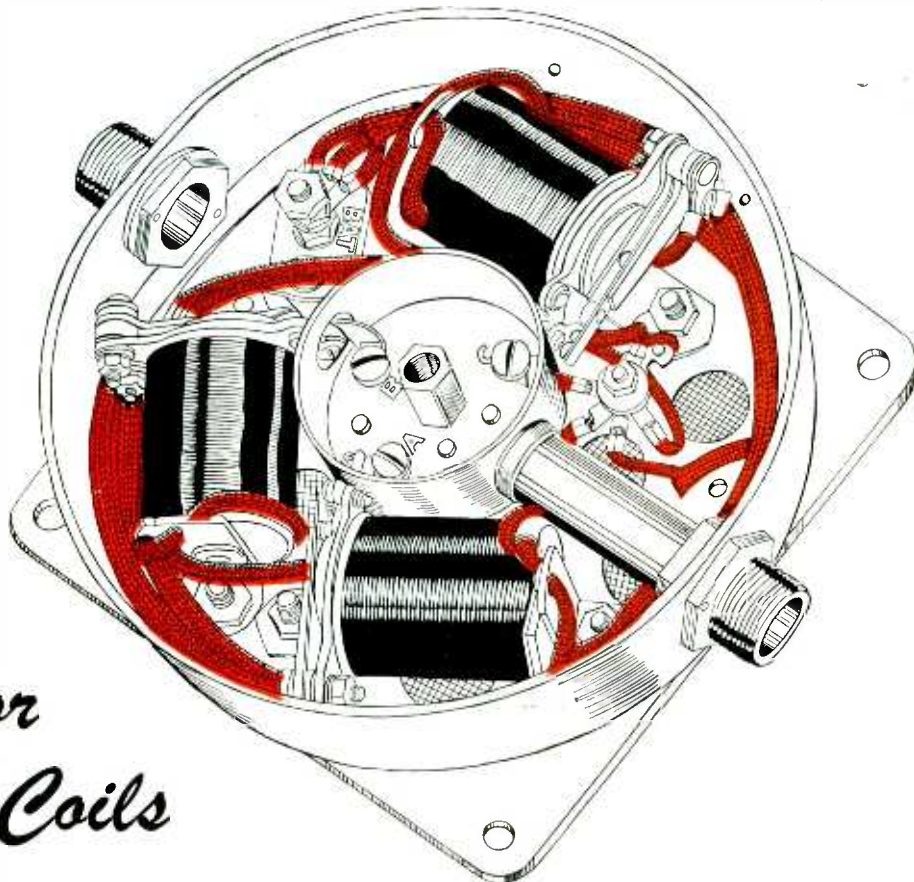

Extra Stamina for Starting Coils

When an aircraft magneto is rotated at low RPM while the aircraft engine is functioning, a small triple unit starting coil introduces a high tension spark into the magneto circuit, resulting in increased temperatures within the unit. Proper insulation is necessary during this period to insure against low voltages.

This is why you find BH Extra Flexible Fiberglass Sleeveing used on the triple unit starting coil of the booster section of the Bendix-Scintilla ignition system. The system is installed on the Pratt Whitney R-4360 Wasp Major engine.

This is what Bendix-Scintilla engineers say:

"BH Extra Flexible Sleeveing is used as added insulation against low voltages. BH Fiberglass Sleeveing is required rather than ordinary varnished tubing because temperatures up to 400 F. are encountered. Its remarkable flexibility and non-fraying qualities are added advantages. Results have been completely satisfactory."

If you have a tough insulation problem in your product or plant where extreme temperatures, excessive current loads, grease or moisture are causing insulation breakdowns, then specify BH Fiberglass Sleeveing. Write today.

BENTLEY, HARRIS MFG. CO., CONSHOHOCKEN, PA.

BH *Fiberglass** SLEEVEINGS

*BH Non-Fraying Fiberglass Sleeveings are made by an exclusive Bentley, Harris process (U. S. Pat. No. 2393530). "Fiberglass" is Reg. TM of Owens-Corning Fiberglass Corp.

----- USE COUPON NOW -----

Bentley, Harris Mfg. Co., Dept. E-28, Conshohocken, Pa.

I am interested in BH Non-Fraying Fiberglass Sleeveing for _____ (product)

operating at temperatures of _____°F. at _____ volts. Send samples so I can see for myself how BH Non-Fraying Fiberglass Sleeveing stays flexible as string, will not crack or split when bent.

NAME _____ COMPANY _____

ADDRESS _____

Send samples, pamphlet and prices on other BH Products as follows:

- Cotton-base Sleeveing and Tubing
- Ben-Har Special Treated Fiberglass Tubing

for mobile two-way radio

ALLIED'S NEW CO-AXIAL RELAY

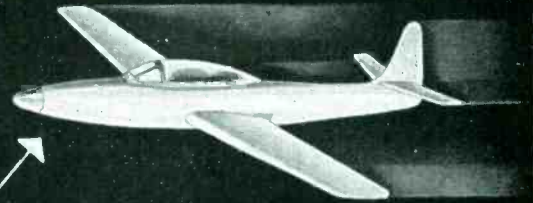
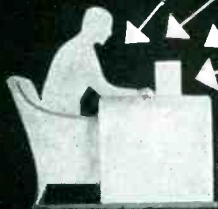
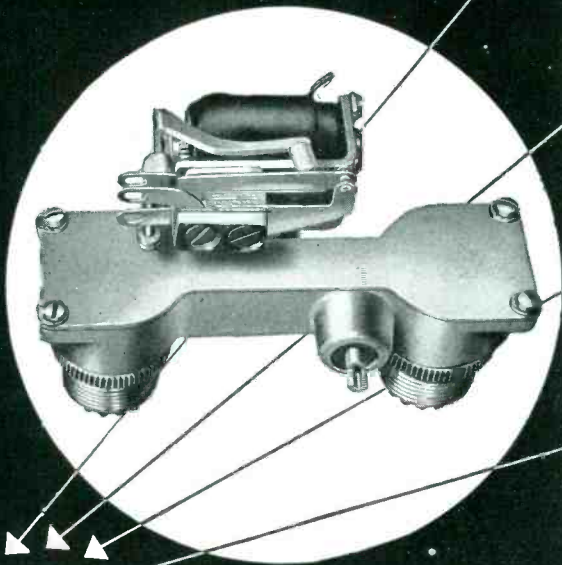

The new Allied "RA" relay transfers 52 ohm antenna transmission line (type RG-8U Cable) from receiving to transmitting position. It is now used in police car radios and is highly recommended for both mobile and stationary applications.

This new relay is equipped with two Co-Axial cable fittings and one insulated transmitter line terminal. Co-Axial fittings for antenna and receiver connection are die cast as part of the metal housing. They will accommodate Signal Corps cable connector PL-259. Auxiliary double-pole, double-throw contacts can be supplied when specified.

NEW RELAY GUIDE
This new folder shows 24 small, compact Allied Relays with a carefully detailed table of characteristics and specifications. Write for YOUR free copy today.

ENGINEERING FEATURES OF THE ALLIED TYPE "RA" RELAY

Contact Rating: Antenna transfer contacts will handle a maximum of 75 watts of radio frequency up to 150 megacycles when inserted in a properly terminated 52 ohm line. Auxiliary contacts have a non-inductive rating of 1 ampere at 24 volts D.C. or 115 volts A.C.
Coil Rating: Up to 110 volts D.C. and 115 volts A.C. 60 cycles.

Coil No.	D.C. Volts	D.C. Current	D.C. Resistance
31	6.	.46	13.
34	12.	.22	54.
38	26.5	.083	320.
40	48.	.060	800.
43	110.	.026	4100.

(This table is based on an average power rating of 2.5 watts. Minimum operating voltages are 80% of voltages shown above.)

Dimensions: 2" x 2 7/8" x 1 3/4". **Weight:** 4 oz.



ALLIED CONTROL COMPANY, INC.
2 EAST END AVENUE, NEW YORK 21, N. Y.

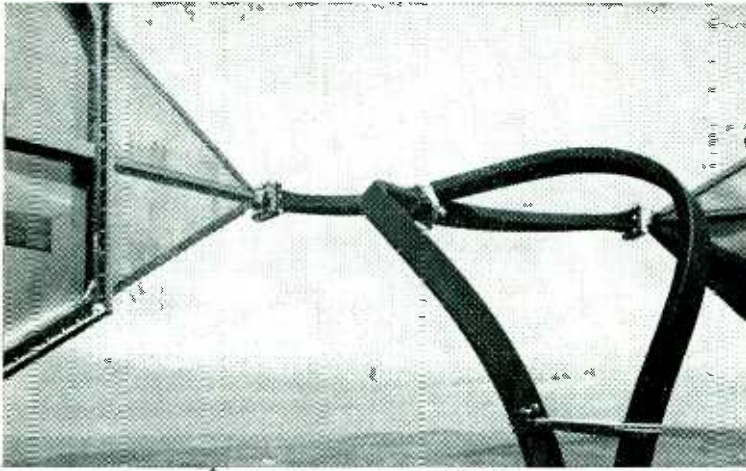

3 The waveguide connects with antennas, which are oriented in azimuth with antennas at next station. At right is complete repeater station.

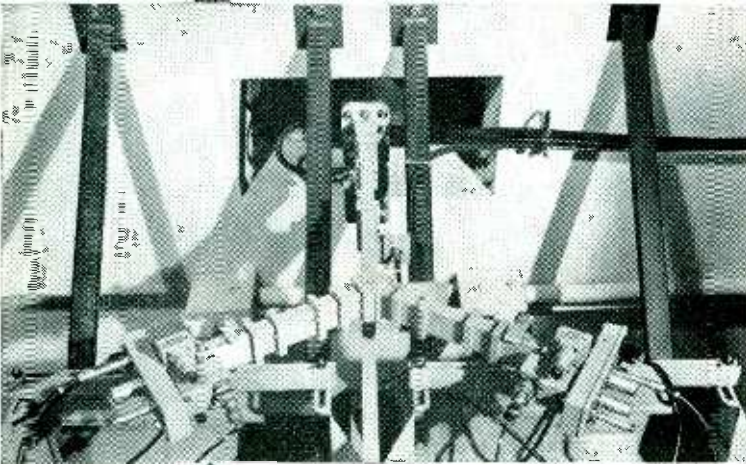

2 The waveguide continues upward through the roof of the station toward the antennas.

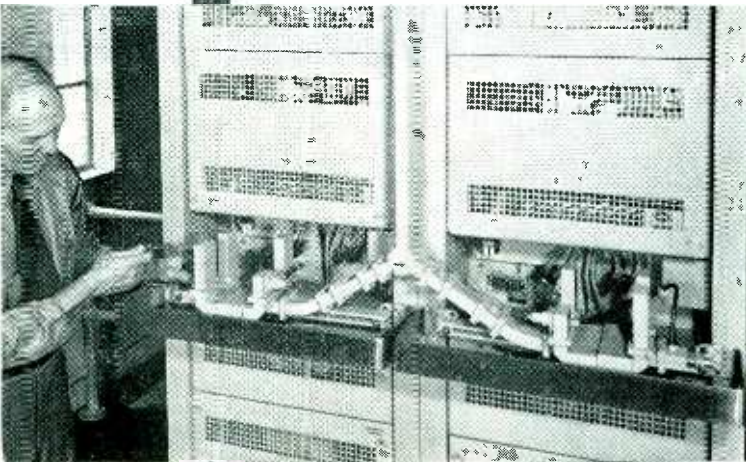

1 Base of a waveguide circuit in a repeater station of the New York-Boston radio relay system.



Pipe Circuits

UNLIKE radio broadcast waves, microwaves are too short to be handled effectively in wire circuits. So, for carrying microwaves to and from antennas, Bell Laboratories scientists have developed circuits in "pipes," or waveguides.

Although the waves travel in the space within the waveguides, still they are influenced by those characteristics which are common to wire circuits, such as capacitance and inductance. A screw through the guide wall acts like a capacitor; a rod across the inside, like an inductance coil. Thus transformers, wave filters, resonant circuits — all have their counterpart in waveguide fittings. Such fittings, together with the connection sections of waveguide, constitute a waveguide circuit.

From Bell Laboratories research came the waveguide circuits which carry radio waves between apparatus and antennas of the New York-Boston radio relay system. As in long distance wire communication, the aim is to transmit wide frequency bands with high efficiency — band widths which some day can be expanded to carry thousands of telephone conversations and many television pictures.

Practical aspects of waveguides were demonstrated by Bell Telephone Laboratories back in 1932. Steady exploration in new fields, years ahead of commercial use, continues to keep your telephone system the most advanced in the world.

BELL TELEPHONE LABORATORIES

EXPLORING AND INVENTING, DEVISING AND PERFECTING FOR CONTINUED IMPROVEMENTS AND ECONOMIES IN TELEPHONE SERVICE.



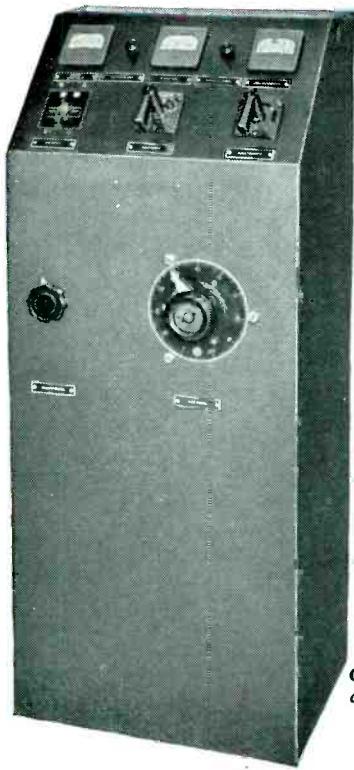

Control panel for use with cascade rectifiers.

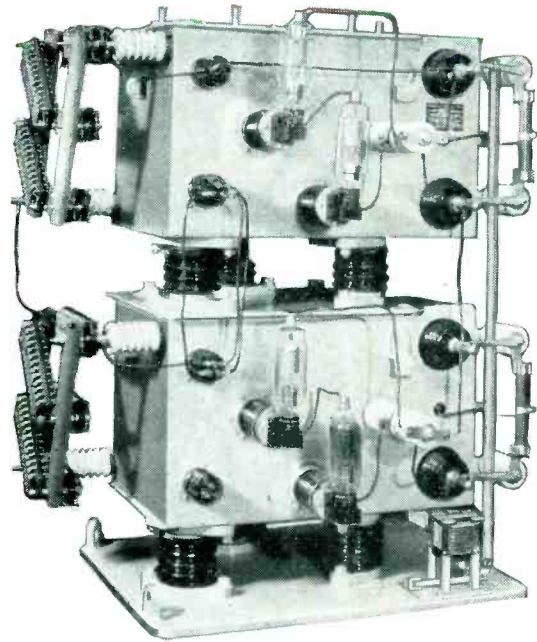

This cascade rectifier, 42 inches high, delivers 70 kv, 15 ma d-c. Consists of two basic Kenotron-tube rectifier units.

Now **SMALL RECTIFIERS** **FOR DC VOLTAGES** *up to 135 KV*

New, within the last year, is this small cascade-type rectifier for generating smooth high d-c voltages. Suitable for laboratory and factory for testing and as power supply. Features: versatility, reliability, reasonable price and long tube life with much lower cost of replacement tubes. The rectifiers can be furnished for single-phase operation from 115- or 230-volt, 50- or 60-cycle power supply.

Basic unit is a 35 kv, 32 ma (continuous) rectifier, with necessary transformers mounted in an oil-filled steel tank. Each unit is 34" wide, 25" deep and 21" high. Up to four units can be

stacked, giving d-c voltages up to 135 kv. Output voltage ripple, peak to peak, will not exceed 0.1% per milli-ampere.

A CONTROL PANEL can be supplied which will provide smooth output voltage control over the complete range from zero to maximum. Accuracy of output voltage, with this panel, is ± 5 per cent of full scale; accuracy of current indication, ± 2 per cent. Overcurrent protection is included.

SUITABLE FOR INTEGRAL MOUNTING. Because of its small size, this rectifier can often be mounted within the en-

closure housing your own product. Such integral mounting is usually preferable from all standpoints—lowers cost, saves space, and improves appearance of the entire assembly.

STANDARD UNITS, IN REGULAR PRODUCTION. These cascade rectifiers are built up of standard units that are in regular production. They can be shipped on shorter schedules than are normal for this general class of equipment.

For prices and specific information, address inquiries to our nearest office, or to General Electric Company, Transformer Sales Division, 16-215, Pittsfield, Mass.

GENERAL  **ELECTRIC**

401-55

Centralab reports to



Models courtesy of Allen-Howe Electronics Corp.

I Size and weight are vital to Allen-Howe, hearing aid manufacturer. That's why this firm's engineers chose Centralab's *Printed Electronic Circuit* to help them design and build smaller, lighter, more efficient units. Months of actual experience using P.E.C.

have proved to them how very rugged these miniature audio-amplifiers are . . . just how well they resist humidity and moisture. That's why they continue to use Centralab's revolutionary P.E.C. Write for Bulletin 973.

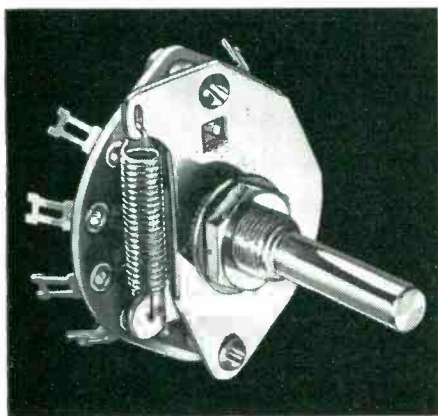

2 Great step forward in switching is CRL's new *Rotary Coil and Cam Index Switch*. Its coil spring gives you smoother action, positive indexing, longer life.

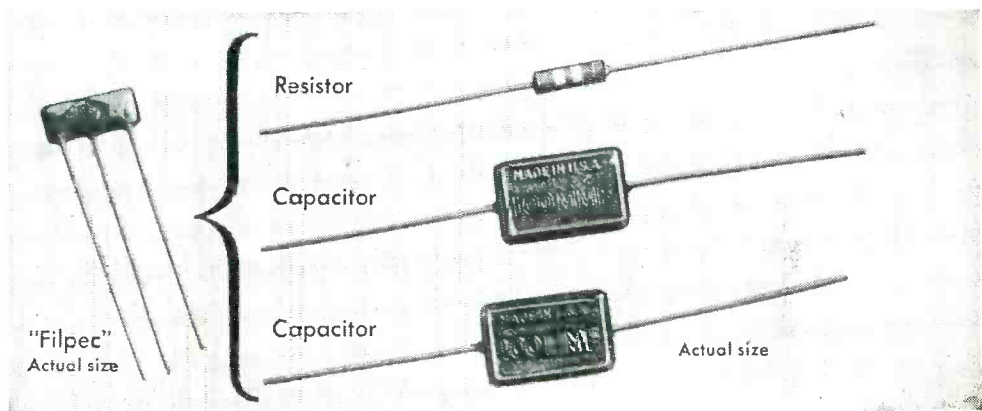

3 Centralab's *Filpec* is designed for use as a balanced diode lead filter, combines up to three major components into one tiny unit, lighter and smaller than one ordinary capacitor. Capacitor values available from: 50 to 200 mmf. Resistor values from 5 ohms to 5 megohms. For complete information, write for Bulletin 976.

Electronic Industry

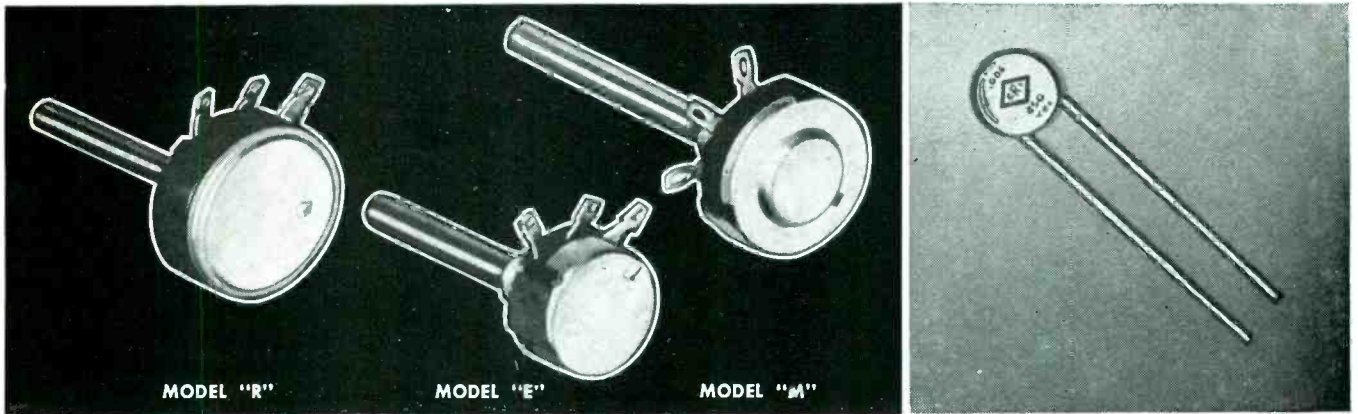

4 Let Centralab's complete Radiohm line take care of your special needs. Wide range of variations: *Model "R"* — wire wound, 3 watts; or composition type, 1 watt. *Model "E"* — composition type, 1/4 watt. Direct contact, 6 resistance tapers, *Model "M"* — composition type, 1/2 watt. Send for Bulletin 697.

5 For utmost reliability in small physical size, low mass weight, use CRL *Hi-Kaps* — miniature ceramic disc capacitors. Write for Bulletin 933.

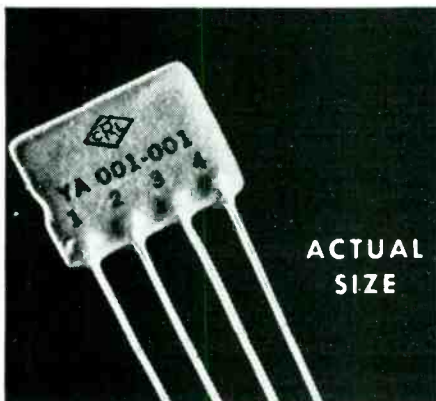

6 CRL's *Couplate* consists of a plate lead resistor, grid resistor, plate by pass capacitor and coupling capacitor. Write for Bulletin 943.

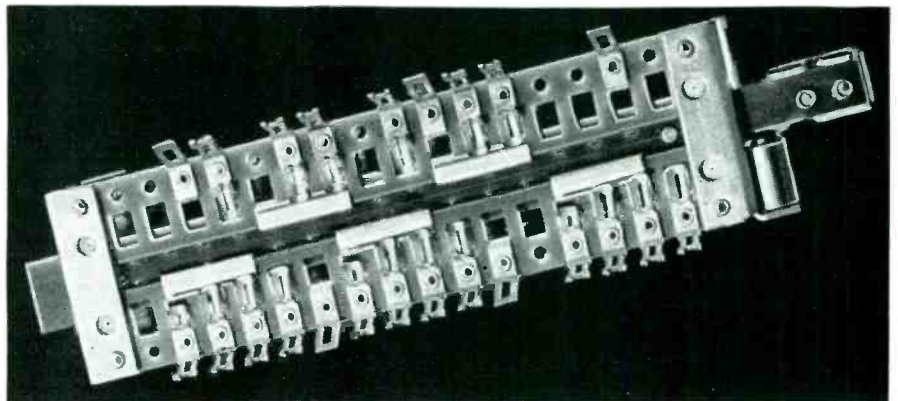

7 Centralab's development of a revolutionary, new Slide Switch promises improved AM and FM performance! Flat, horizontal design saves valuable space, allows short leads, convenient location to coils, reduced lead inductances for increased efficiency in low and high frequencies. Rugged, efficient. Write for Bulletin 953.

LOOK TO CENTRALAB IN 1948! *First in component research that means lower costs for the electronic industry. If you're planning new equipment, let Centralab's sales and engineering service work with you. Get in touch with Centralab!*

Centralab

DIVISION OF GLOBE-UNION INC., MILWAUKEE, WIS.

ONE OF THESE 5 WILL BEST FILL YOUR V.O.M. REQUIREMENTS



MODEL 630. Outstanding Features: (1) The new Triplett Molded Selector Switch with contacts fully enclosed . . . (2) Has Unit Construction with Resistor Shunts, Rectifier Batteries in molded base . . . (3) Provides direct connections without cabling . . . no chance for shorts . . . (4) Big easily read 5 1/2" Red • Dot Lifetime Guaranteed Meter.

TECH DATA

D.C. VOLTS: 0-3-12-60-300-1200-6000, at 20,000 Ohms/Volt
 A.C. VOLTS: 0-3-12-60-300-1200-6000, at 5,000 Ohms/Volt
 D.C. MICROAMPERES: 0-60, at 250 Millivolts
 D.C. MILLIAMPERES: 0-1, 2-12-120, at 250 Millivolts
 D.C. AMPERES: 0-12, at 250 Millivolts
 OHMS: 0-1000-10,000, 4.4 Ohms at center scale on 1000 scale; 44 Ohms center scale on 10,000 range.
 MEGOHMS: 0-1-100 (4400-440,000 at center scale).
 DECIBELS: -30 to -4, -16, -30, -44, -56, -70.
 OUTPUT: Condenser in series with A.C. Volt ranges.

MODEL 630. . . . U.S.A. Dealer net price . . . \$37.50
 Leather Carrying Case, \$5.75. . . Adapter Probe for TV and High Voltage Extra.

MODEL 666-HH. This is a pocket-size tester that is a marvel of compactness and provides a complete miniature laboratory for D.C. and A.C. voltages, Direct Current and Resistance analyses. Equally at home in the laboratory, on the work bench or in the field . . . its versatility has labeled it the tester with a thousand uses . . . housed in molded case . . .

TECH DATA

D.C. VOLTS: 0-10-50-250-1000-5000, at 1,000 Ohms/Volt
 A.C. VOLTS: 0-10-50-250-1000-5000, at 1,000 Ohms/Volt
 D.C. MILLIAMPERES: 0-10-100-500, at 250 Millivolts
 OHMS: 0-2,000-400,000, (12-2400 at center scale)

MODEL 666-HH. . . . U.S.A. Dealer Net Price . . . \$22.00
 Leather Carrying Case, \$4.75.

MODEL 625-NA. This is the widest range laboratory-type instrument with long 5.6" mirrored scale to reduce parallax. Special film resistors provide greater stability on all ranges. Completely insulated molded case. Built by Triplett over a long period of time, it has thoroughly proved itself in laboratories all over the world.

TECH DATA

SIX D.C. VOLTS: 0-1-25-5-25-125-500-2500, at 20,000 Ohms/Volt
 SIX D.C. VOLTS: 0-2.5-10-50-250-1000-5000, at 10,000 Ohms/Volt
 SIX A.C. VOLTS: 0-2.5-10-50-250-1000-5000, at 10,000 Ohms/Volt
 D.C. MICROAMPERES: 0-50, at 250 Millivolts
 D.C. MILLIAMPERES: 0-1-10-100-1000, at 250 Millivolts
 D.C. AMPERES: 0-10: at 250 Millivolts

TRIPLETT ELECTRICAL INSTRUMENT COMPANY • BLUFFTON, OHIO, U.S.A.

In Canada: Triplett Instruments of Canada, Georgetown, Ontario

OHMS: 0-2000-200,000, (12-1200 at center scale)
 MEGOHMS: 0-40, (240,000 at center scale)
 SIX DECIBELS RANGES: -30 +3.0, +15, +29, +43, +55, +69.
 (Reference level "O" DB at 1.73 V. on 500-Ohm line.)
 Six Output on A.C. Volts ranges.

MODEL 625-NA. . . . U.S.A. Dealer Net Price . . . \$45.00
 Carrying Case, \$5.50. Accessories available on special order for extending ranges.

MODEL 2405-A. This instrument combines ultra sensitivity with a large 5 3/4" scale meter and is housed in a rugged metal case. . . It is furnished with hinged cover so that it can be used for service bench work or for portable field service. Gives A.C. Amperes readings to 10 Amps.

TECH DATA

D.C. VOLTS: 0-10-50-250-500-1000, at 20,000 Ohms/Volt
 D.C. AMPERES: 0-10, at 250 Millivolts
 D.C. MILLIAMPERES: 0-1-10-50-250, at 250 Millivolts
 D.C. MICROAMPERES: 0-50, at 250 Millivolts
 A.C. VOLTS: 0-10-50-250-500-1000 at 1000 Ohms/Volt
 A.C. AMPERES: 0-0.5-1-5-10, at 1 Volt-Ampere
 OHM-MEGOHMS: 0-4000-40,000 ohms-0.4-40 megohms (self-contained batteries)
 OUTPUT: Condenser in series with A.C. Volts ranges
 DECIBELS: -10 to +15, +29, +43, +49, +55. (Reference level "O" DB at 1.73 V. on 500-ohm line.)
 CONDENSER TEST: Capacity check of paper condensers is possible by following data in instruction book.

MODEL 2405-A. . . . U.S.A. Dealer Net Price . . . \$59.75

MODEL 2451. Electronic Volt-Ohm-Mil-Ammeter . . . is easy to use in complicated testing . . . A must in F.M. and TV work in any sensitive circuit where low current drain is a factor . . .

TECH DATA

D.C.-A.C.-A.F. VOLTS: 0-2.5-10-50-250-500-1000
 R.F. VOLTS: 0-2.5-10-50
 D.C. MILLIAMPERES: 0-2.5-10-50-250-500-1000
 OHMS: 0-1K-10K-100K
 MEGOHMS: 0-1-10-100
 INPUT IMPEDANCE: 11 Megohms on D.C. Volts.
 4.8 Megohms on A.C.-R.F. Volts

MODEL 2451. . . . U.S.A. Dealer Net Price . . . \$76.50
 External high-voltage probe available on special order. See the Triplett V.O.M. line at your local Radio Parts Distributor or write

Precision first... to Last



Plastics where plastics belong



It is a combination of chemical, electrical, physical, and mechanical properties which makes Synthane laminated plastics valuable in so many applications. Synthane is moisture and corrosion resistant, easily machined and weighs only about half as much as aluminum. One of the best electrical insulators known, Synthane is hard, dense, strong and has excellent anti-frictional qualities. Synthane is also the set plastic . . . not affected by wide variations in temperature.

Among the more domestic occupations of our type of plastics are these bushings used in Dormeyer Food Mixers.

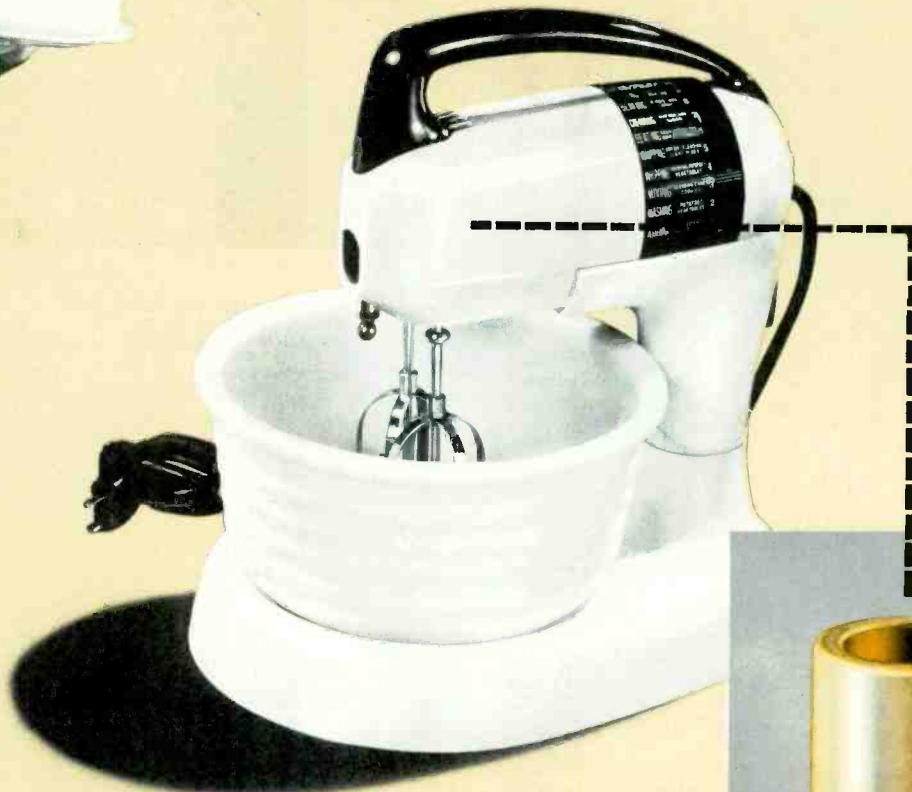

for electrical insulation, wear resistance and mechanical strength.

The brush holder bushings (above) utilize Synthane's outstanding electrical qualities—high dielectric strength, low moisture absorption, high dielectric constant—to insulate the brush mechanism. In addition, Synthane's unusual mechanical strength helps them render long and useful service without need of replacement. These and other hard-working properties also fit Synthane for use in fans, refrigerators, washing machines, vacuum cleaners, ironers, sewing machines and many other electrical appliances.

If there's a use for Synthane in your product, let us help you with design, materials or completely fabricated parts. Write for your free copy of our complete catalog of Synthane plastics today! Synthane Corporation, 6 River Road, Oaks, Pa.

SYNTHANE

S

where Synthane belongs

DESIGN • MATERIALS • FABRICATION • SHEETS • RODS • TUBES
FABRICATED PARTS • MOLDED-MACERATED • MOLDED-LAMINATED

STUMPED?

By a material problem?
PLAN WITH PLASTICS

SEND FOR THIS COMPLETE CATALOG

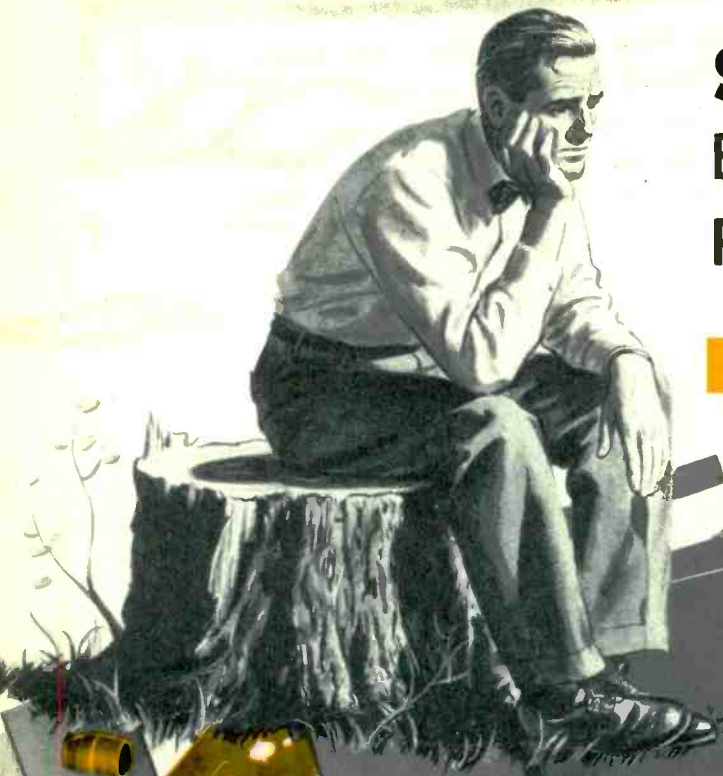

SYNTHANE
S
TECHNICAL PLASTICS

Labels in the diagram include: EASILY MACHINED, SOUND ABSORBING, MOISTURE RESISTANT, DIMENSIONAL STABILITY, EXCELLENT ELECTRICAL INSULATION, THERMO-SETTING, HARD, ABRASION RESISTANT, CORROSION RESISTANT, STRUCTURALLY STRONG, LIGHTWEIGHT, and RESILIENT.

SYNTHANE
sheet properties
 variety of grades
 The properties of Synthane can be varied by varying the sheet thickness, the processing, and the application of the standard grades described.

finishes
 Since Synthane sheets are available in a variety of finishes, the user can select the finish that best suits his requirements. The finishes available are: standard, chrome, and chrome with a clear protective coating.

grades
 XX, XXX, CE, LE
 X, C, L, A, AA
 RP, XRP, RKSP

sheet sizes
 Standard Synthane sheets are available in 24" x 100" and 36" x 100" sizes.

colors
 All Synthane grades are available in a variety of colors. Black is available in all grades. A and AA chocolate brown, green, red, green, white, etc. can be obtained.

standard thickness table
 Synthane sheets are furnished in standard thicknesses. At least 10% of the sheets will be within the tolerances given. Tolerances as given vary from 125% of the specified tolerance.

thickness

tolerance

acids
 Synthane is resistant to most acids.

alkalis
 Synthane is resistant to most alkalis.

solvents
 Synthane is resistant to most solvents.

temperature
 Synthane is resistant to most temperatures.

four

SYNTHANE CORPORATION, 6 RIVER ROAD, OAKS, PA.

Gentlemen:
 Please send me without obligation a complete catalog of Synthane technical plastics.

Name _____
 Company _____
 Address _____
 City _____ Zone _____ State _____

THIS COUPON BRINGS YOUR COPY

Solve your present and future design problems with SYNTHANE Technical Plastics • Sheets • Rods • Tubes • Fabricated parts • Molded-laminated • Molded-macerated. Consult us before you design and save time and trouble.



You can match the characteristics of most transcriptions and recordings...

...with the 109 Type Reproducer Group

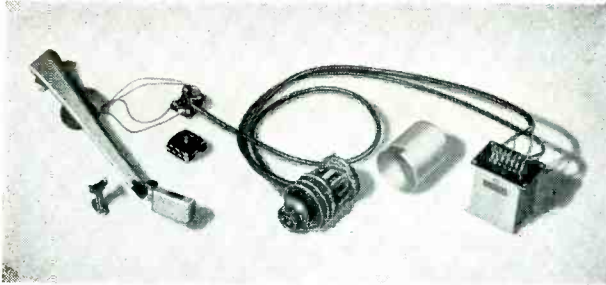

Recording characteristics vary widely from one company's recordings to another. But... when you use the Western Electric 109 Type Reproducer Group, with its 7-position Equalizer, you can correct for practically any of the more commonly used recording characteristics.

Note in the adjoining panel how closely the 109 Type Group equalizes not only for the NAB and Orthacoustic curves, but also for commercial records and lateral transcriptions. In fact, you can match within close tolerances all vertical and most lateral transcriptions and 90% of phonograph records.

That's one factor in the high-quality performance of the 109 Type Group. Another is the exceptionally low intermodulation distortion of the 9 Type Reproducer. Hear the Group for yourself — note how this feature reduces "hash" at the higher frequencies.

The 109 Type Group consists of reproducer arm, your choice of 9A or 9B Reproducer, equalizer and cable assembly, and repeating coil. You can easily mount this top-performance group on your present turntables—and you can get it from stock!

Place your order with your local Graybar Representative — or write Graybar Electric Co., 420 Lexington Ave., New York 17, N. Y.



— QUALITY —
COUNTS

DISTRIBUTORS: IN THE U. S. A. — Graybar Electric Company, IN CANADA AND NEWFOUNDLAND—Northern Electric Co., Ltd.

Western Electric

See how closely the 109 duplicates all of these recording curves

Recording Characteristic _____
109 Type Reproducer Group (using average production reproducer) - - - - -

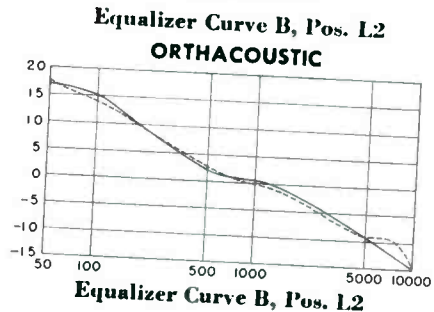
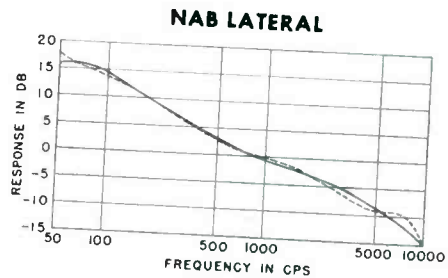

Typical curves for commercial records and transcriptions

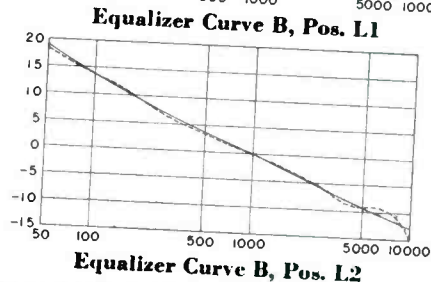
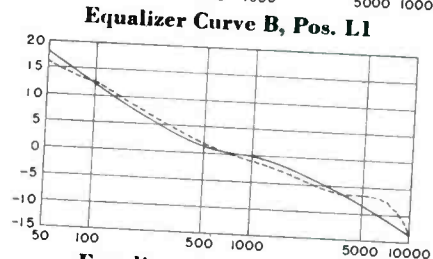
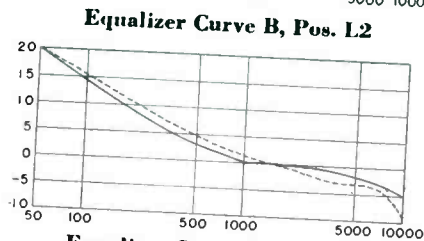
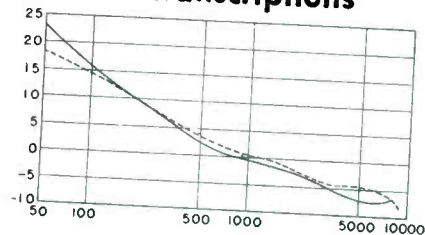

PERSONALLY CONDUCTED THROUGH THE REVERE MILLS

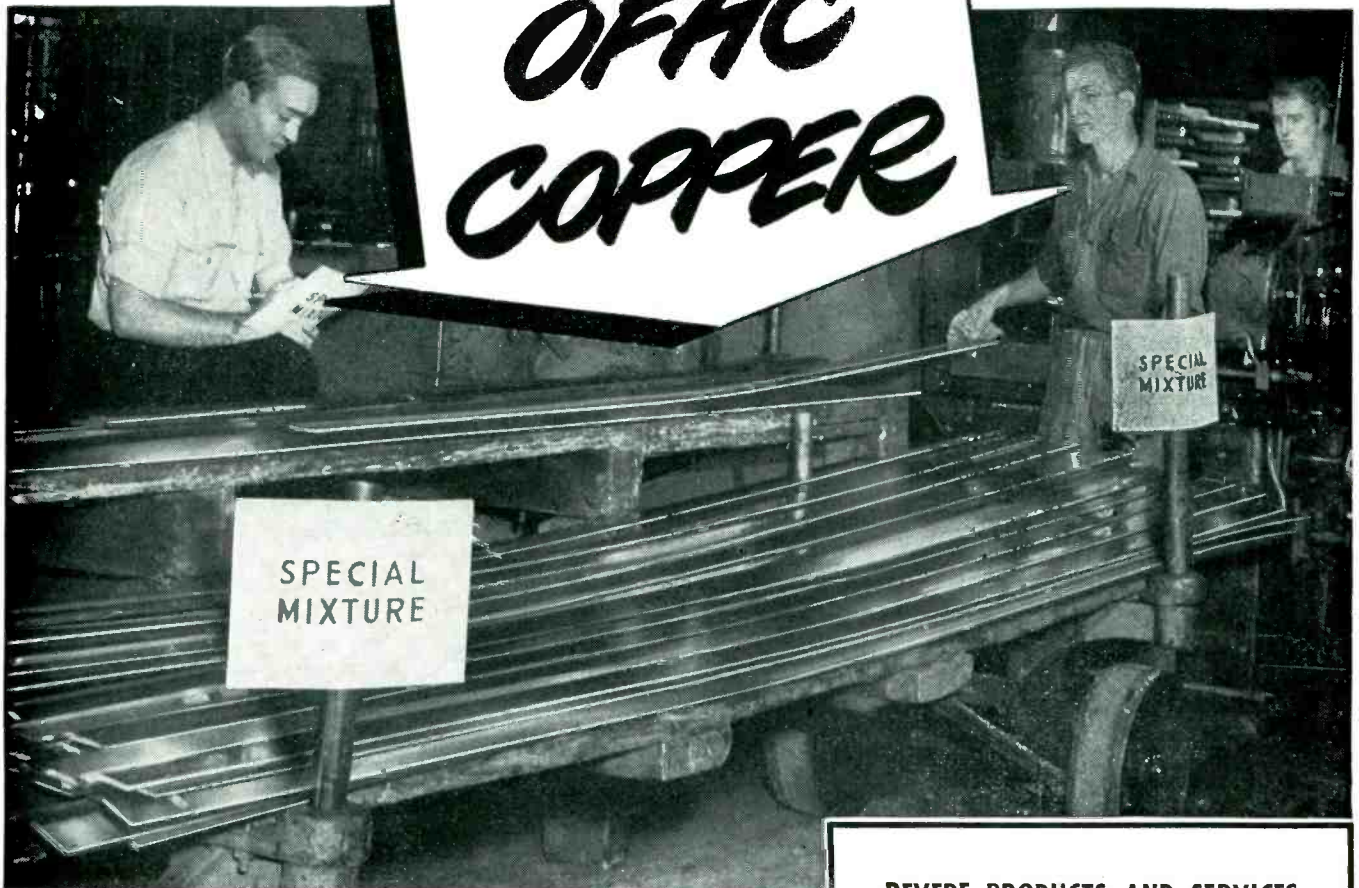

BECAUSE OFHC Copper looks like any other copper, Revere takes great pains to identify it throughout processing, to see it is not lost track of or mixed up with other types. The obvious thing is to mark each piece, which is done, but markings are obliterated by operations such as rolling, and so Revere goes to the length of assigning special personnel to follow each lot of OFHC Copper from one operation to another, watching carefully to be sure each load is kept intact.

In addition, Revere takes full cognizance of the fact that OFHC Copper for radio purposes must have special qualities. In making anodes, it must be deep drawn, and for the feather-edge seal, it must be capable of being rolled or machined down to .002"/.010". By carefully controlling mill processing, grain size is kept at or below permissible limits. Freedom from oxygen, and from voids, is guaranteed by the method of casting the bars from which we roll the forms required. In addition, there is an operation which results in Revere OFHC Copper being not just commercially free but *nearly absolutely free* of internal and external defects. This great care in producing copper for radio and radar purposes probably accounts for the fact that Revere is a preferred source of supply.

REVERE PRODUCTS AND SERVICES

All Revere Metals are processed with the care and attention required to assure that they meet all metallurgical and physical specifications. Revere supplies mill products in non-ferrous metals and alloys, and also electric welded and lockseam steel tube. An important part of our service to industry is the Revere Technical Advisory Service, which will gladly collaborate with you on specifications and fabrication methods.

REVERE

COPPER AND BRASS INCORPORATED

Founded by Paul Revere in 1801

230 Park Avenue, New York 17, New York

*Mills: Baltimore, Md.; Chicago, Ill.; Detroit, Mich.;
New Bedford, Mass.; Rome, N. Y.*

Sales Offices in Principal Cities, Distributors Everywhere

Hi-Q

TUBULAR CERAMIC CAPACITORS



CN-1 .200x .375



CN-13 .200x .437



CN-2 .200x .625



CN-27 .230x .460



CN-7 .230x .812



CN-19 .253x .850



CN-3 .253x 1.078



CN-4 .340x 1.062



CN-5 .340x 1.500



CN-6 .340x 1.875



SI-1 .234x .437



SI-13 .234x .468



SI-2 .234x .687



SI-27 .275x .500



SI-7 .275x .875



SI-19 .312x .937



SI-3 .312x 1.125



SI-4 .375x 1.093

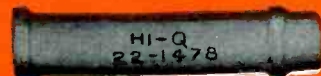

SI-5 .375x 1.600



SI-6 .375x 1.968



CI-1 .250x .562



CI-2 .250x .812



CI-3 .340x 1.320



CS-1



CS-2



CS-3



CS-4



CF-1



CF-2



CF-3

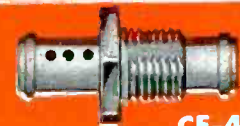

CF-4

ALL DIMENSIONS ARE MAXIMUM

**ELECTRICAL REACTANCE
CORPORATION**

GENERAL OFFICES:
● FRANKLINVILLE, N. Y.
SALES OFFICES:
● IN ALL PRINCIPAL CITIES

No Service is too Rugged for **FEDERAL...**

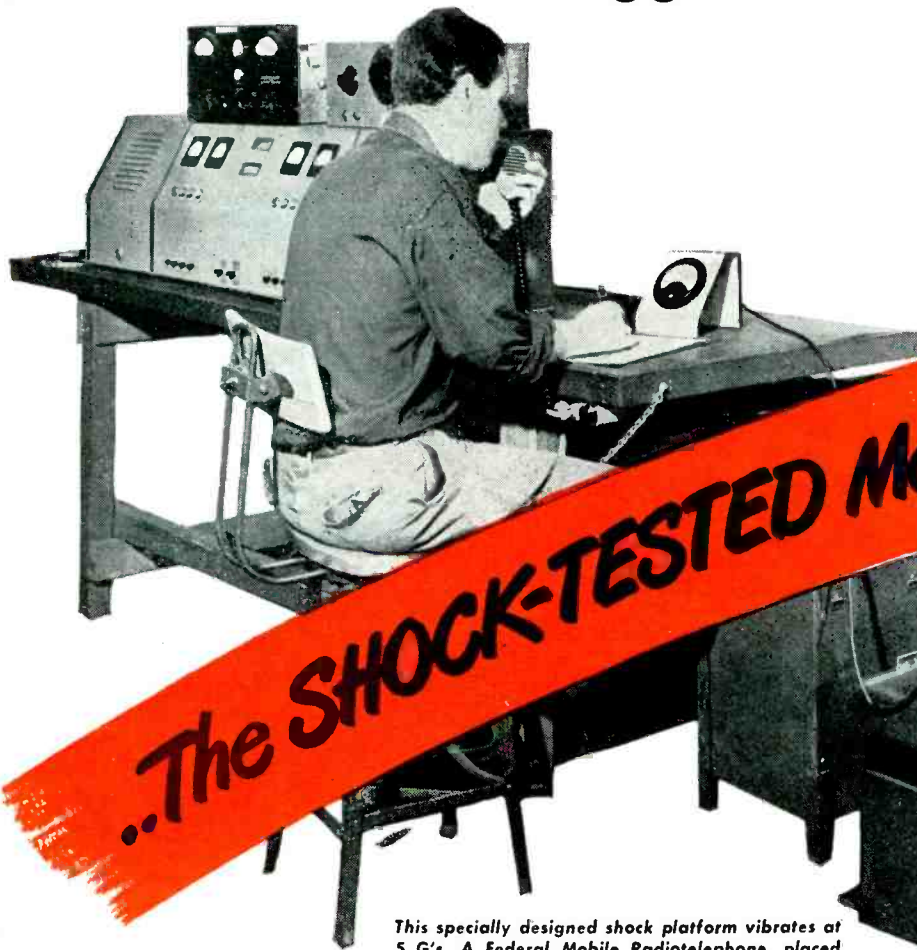

..The **SHOCK-TESTED** Mobile Radio

This specially designed shock platform vibrates at 5 G's. A Federal Mobile Radiotelephone, placed on it without shock mounts, must operate perfectly throughout a shock test of 10 minutes.

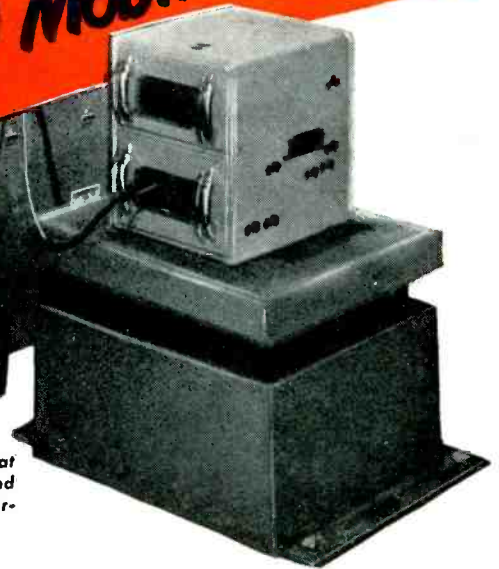

You can specify Federal Mobile Radiotelephone with confidence—and be sure of the finest performance under the toughest operating conditions. At the factory, every Federal Mobile Radiotelephone has to operate at peak efficiency under “engineered” conditions that far exceed those encountered normally in police, fire, taxi, utility, bus, truck, forestry or any other kind of duty.

Every Federal Mobile Radiotelephone undergoes a test even more severe than that given to military tank and aircraft equipment—the Federal “shock test.” The unit is vibrated, *with-*

out shock mounts, at 5 G's—which is the force of an impact equivalent to 5 times its own weight. This rigorous test continues for 10 minutes while the equipment is in actual operation.

This is only one of the thorough tests which every Federal Mobile Radiotelephone must pass—and pass with flying colors—before it is shipped. You will find it profitable to get the facts on Federal... the shock-tested Mobile Radiotelephone. Write to Department I-716.

*Federal's Mobile
Transmitter-Receiver Unit*

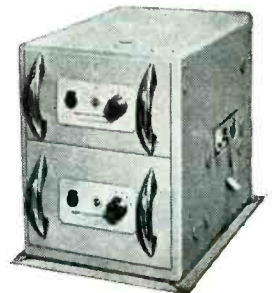

KEEPING FEDERAL YEARS AHEAD... is IT&T's world-wide research and engineering organization, of which the Federal Telecommunication Laboratories, Nutley, N. J., is a unit.

Federal Telephone and Radio Corporation

100 KINGSLAND ROAD, CLIFTON, NEW JERSEY

In Canada: Federal Electric Manufacturing Company, Ltd., Montreal, P. Q.
Export Distributors: International Standard Electric Corp. 67 Broad St., N. Y.

PROGRESS REPORT ON P.E.C.*

How Microtone uses
twelve *Printed Electronic Circuit* units
to save space and simplify
production of fine hearing aids!



Microtone's Sealed Power Amplifiers consist of 12 Centrallab *Filpecs* molded into two units for greater compactness . . . quicker installation . . . faster servicing.

Models courtesy of The Microtone Co.

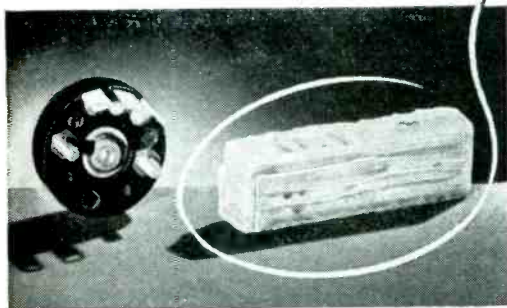

MODEL No. 1 RADIOHM (above, left) and ten *Filpecs* molded into a single amplifying unit (above, right) help Microtone build hearing aids that are smaller, more efficient and easily serviced. *Filpec* is shown below.

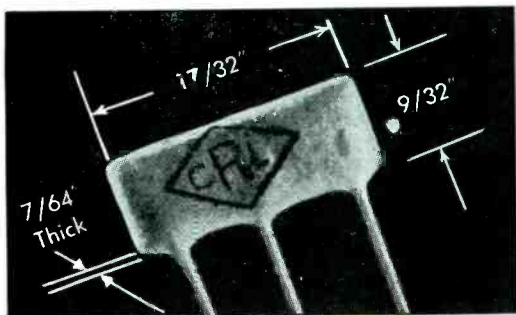

*Centrallab's "Printed Electronic Circuit"
— Industry's newest method for
improving design and manufacturing efficiency!

HEARING AIDS are smaller and lighter. Hearing aid performance is better . . . absolutely unaffected by moisture and humidity. Centrallab's amazing *Printed Electronic Circuit* is an important reason . . . and the Microtone hearing aid is important proof. When Microtone engineers switched to P.E.C. "*Filpec*," here's what they found. Centrallab's *Filpec* cuts down size and weight by reducing the number of components needed. It makes increased production possible by eliminating many assembling operations. It improves performance by minimizing the chance of broken or loose connections.

Integral Ceramic Construction: Each *Printed Electronic Circuit* is an integral assembly of "*Hi-Kap*" capacitors and resistors closely bonded to a seatite ceramic plate and mutually connected by means of metallic silver paths "printed" on the base plate.

You'll want to see and test this exciting new electronic development. For complete information about "*Filpec*" as well as other CRL *Printed Electronic Circuits*, see your nearest Centrallab Representative, or write for Bulletin 976.

LOOK TO **Centrallab** IN 1948!

Division of GLOBE-UNION INC., Milwaukee

This NEW DuMont Type 248-A

does the work of 2 oscillographs

1 WITH THE TYPE 5RP-A CATHODE-RAY TUBE AT 4000 VOLTS ACCELERATING POTENTIAL

The new Du Mont Type 248-A, which replaces the former Type 248 in the medium-voltage field, now employs the Type 5RP-A Cathode-ray Tube at an accelerating potential of 4000 volts. As a wide-band oscillograph (5mc) for studies of pulses and other signals containing high-frequency components, the Type 248-A still provides all the desirable features of the discontinued Type 248. In addition, it may be used immediately as a high-voltage os-

cillograph simply by plugging in a suitable power supply. No modification is necessary.

Thus the new Type 248-A can take the place of two instruments—a medium-voltage and a high-voltage cathode-ray oscillograph. And, best of all, production economies allow the new Type 248-A to be sold at the same low price of the former Type 248.

Now, more than ever, the Type 248-A excels any instrument in its class!



Du Mont Type 248-A
Cat. No. 1244-E, with 5RP2-A
\$1870.00

2 AND FOR OPERATION AT 14,000 VOLTS ACCELERATING POTENTIAL, JUST PLUG IN THE TYPE 263-B HIGH-VOLTAGE POWER SUPPLY

The requirements of modern oscillography frequently demand relatively high accelerating potentials for the investigation and photo-recording of high-speed transients and pulses of extremely low repetition-rates. 14,000 volts accelerating potential is immediately available for these studies, with the Type 248-A, by simply plugging in a power supply such as the new Du Mont Type 263-B. No modification is necessary.

With the power supply and the Type 2088 Projection Lens, the Type 248-A becomes also a projection oscillograph.

The facility with which the range and versatility of the Type 248-A are thus increased, together with the availability of such Du Mont accessories as projection lenses, power supplies and oscillograph record cameras, is further evidence that in oscillography, Du Mont is *always* your best buy.



Du Mont Type 263-B
High-Voltage Power Supply
Cat. No. 1208-E \$142.50

Technical details on request

ALLEN D. DU MONT LABORATORIES, INC.

DU MONT

for Oscillography

ALLEN B. DU MONT LABORATORIES, INC., PASSAIC, N. J.
CABLE ADDRESS: ALBEEDU, NEW YORK, N. Y., U. S. A.

NEW DESIGNS

ENSURING GREATER EFFICIENCY

in R.F. HEATERS and TRANSMITTERS

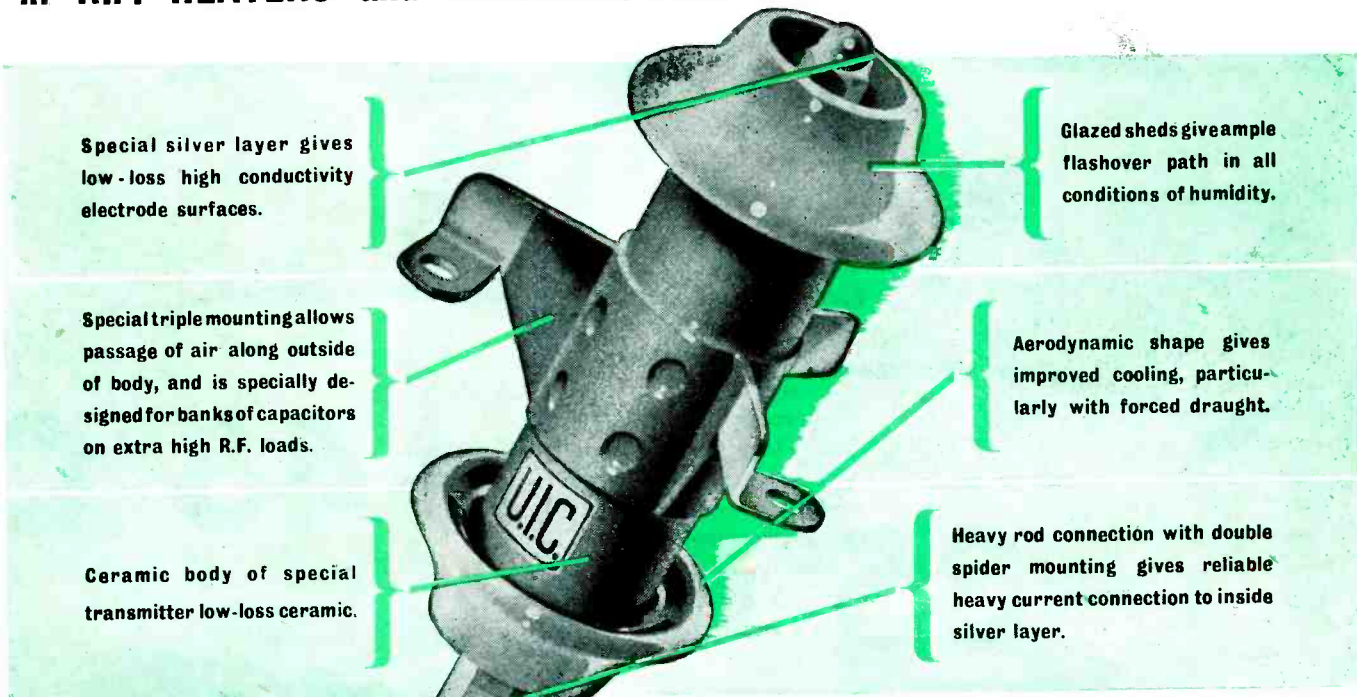

TRIPLE MOUNTING TYPE

U.I.C.

CERAMIC *Hi-Load* CAPACITORS

Designs registered U.S.A., U.K. and other territories.

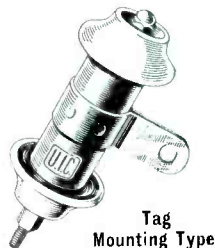

SAMPLES FROM THE RANGE OF 24 TYPES

TYPE	HLS2033	HLT2024*	HLT2023	HLC2013	HLC2013
Capacitance	200	430	500	820	1250
Max. R.F. Load	70	50	50	25	25
Peak Voltage	7.5KV	7.5KV	7.5KV	7.5KV	7.5KV
Max. R.F. Current	30 Amps.	30 Amps.	30 Amps.	30 Amps.	30 Amps.
Body Dimensions	1 1/8" x 3 1/2"	1 1/8" x 3 1/2"	1 1/8" x 3 1/2"	1 1/8" x 3 1/2"	1 1/8" x 3 1/2"

* Lead-through type, all other examples triple mounting type.

U.I.C.

UNITED INSULATOR CO. LTD

Unsurpassed in Ceramics

ELECTRONICS — November, 1948

TOLWORTH, SURBITON, SURREY, ENGLAND · Cables: CALANEL, SURBITON, SURREY

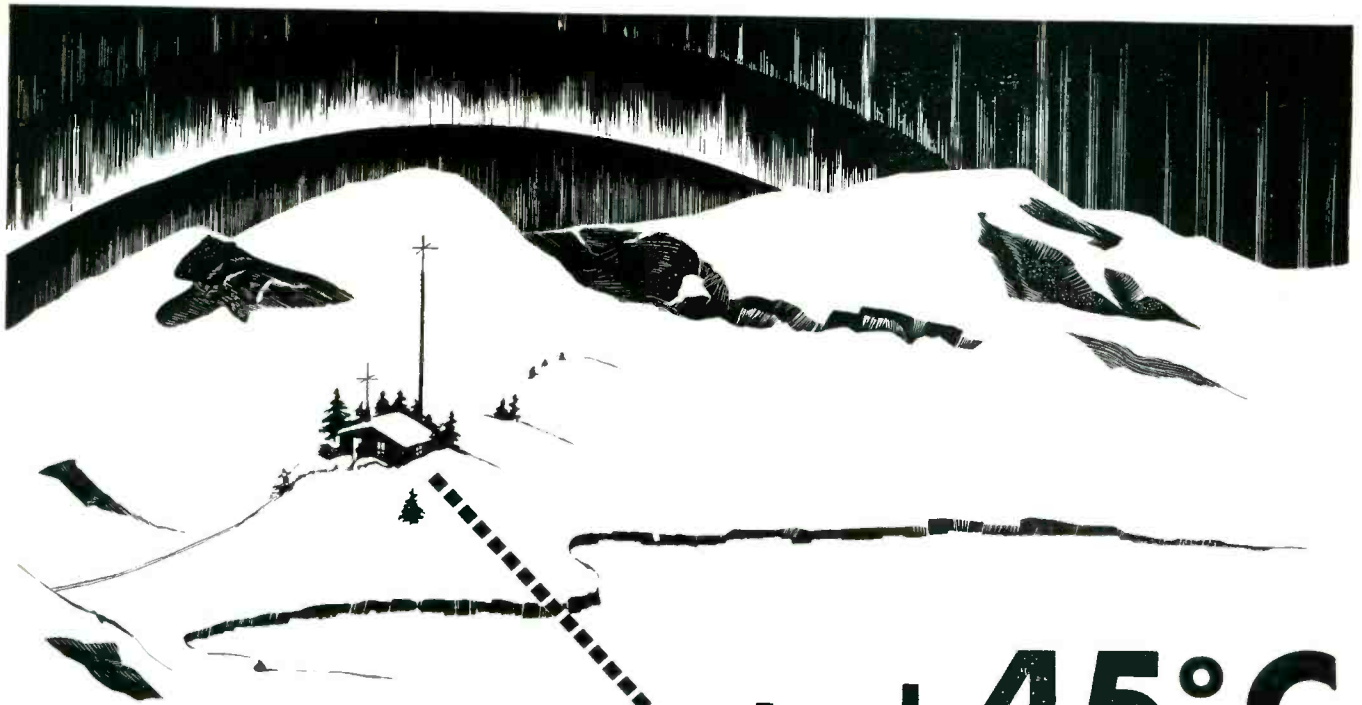

-35°C to +45°C

Aerocom's new V.H. frequency AM radiotelephone transmitter is designed and built to operate amid ice and snow or steaming jungles, and what's more, this fine transmitter will give long trouble free efficient service with low maintenance and operating costs. Built in two models VH-200 and VH-50 to meet your communications needs.

Model VH-200

The model illustrated (VH-200) operates on one Crystal Controlled frequency (plus one closely spaced frequency) anywhere in the range 118-132 Mcs. or 132-165 Mcs., A-2 (with accessory unit) or A-3 AM. Nominal carrier power 200 watts up to 132 Mcs., reduced power up to 165 Mcs. Low temperature operation using gas filled rectifiers. Normal temperature operation using mercury vapor rectifiers. Relative humidity up to 95%. Model VH-50 has similar characteristics except nominal carrier power is 50 watts. Complete technical data on both models on request. Aerocom builds other radiotelegraph and telephone transmitters with accessories, and invites your inquiry if you have a communications problem.

CONSULTANTS, DESIGNERS AND MANUFACTURERS OF STANDARD OR SPECIAL ELECTRONIC, METEOROLOGICAL AND COMMUNICATIONS EQUIPMENT

AER - O - COM
(Reg. U.S. Pat. Off.)

AERONAUTICAL COMMUNICATIONS EQUIPMENT, INC.
3090 Douglas Road, Miami 33, Florida

DEALERS: Equipetro Ltda., Caixa Postal 1925, Rio de Janeiro, Brasil ★ Henry Neuman Jr., Apartado Aéreo 138, Barranquilla, Colombia



PHILCO

VISUAL ALIGNMENT GENERATOR

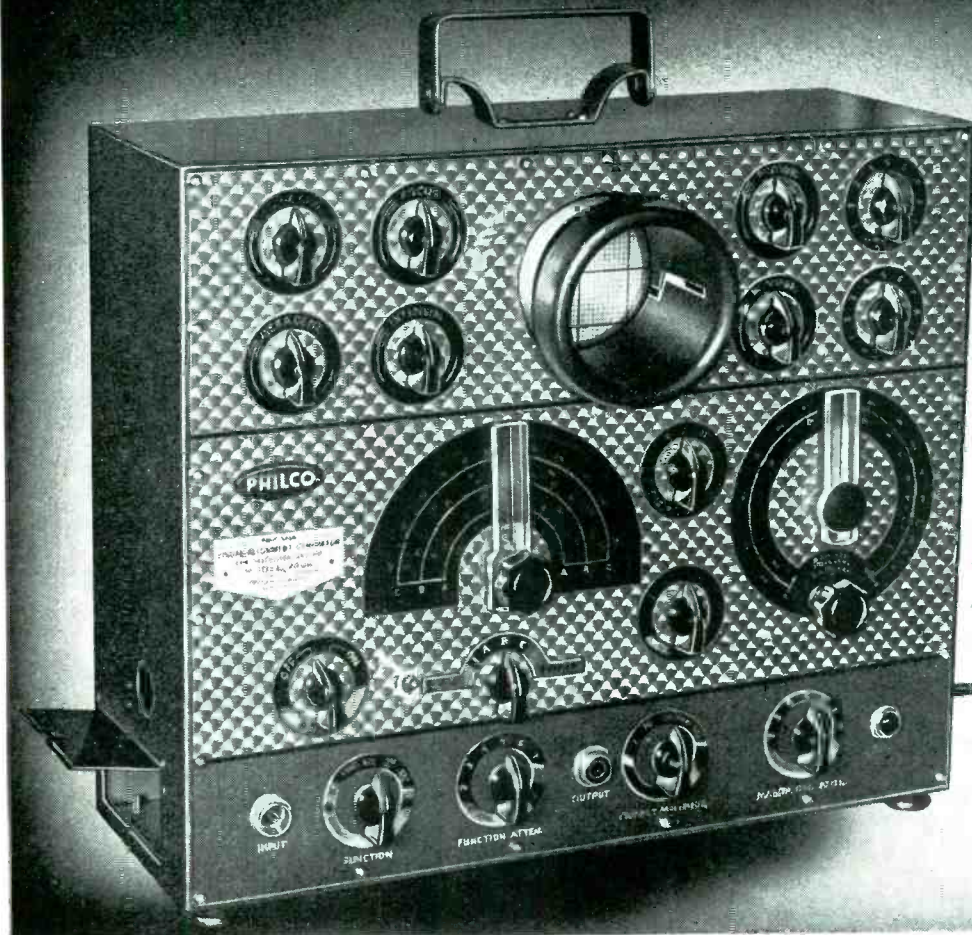

For the Radio and Television Serviceman — for the Experimenter — for the Amateur — for the Radio-Electronics Engineer

PHILCO 7008

The only completely self-contained and moderately priced instrument for aligning television and FM receivers. Includes 5 different signal generators with their associated controls; a complete oscilloscope with centering, gain, focus, intensity, phasing and blanking controls, and power supplies; separate RF probe for measurements of sensitive circuits without disturbance. Removable crosshatch screen for ultra-short 3" cathode-ray tube. Compartment for cables and RF probe.

WRITE FOR TECHNICAL LITERATURE
Philco Corporation, Philadelphia 34, Pa.

- No. 7008 Philco Visual Alignment Generator
- No. 7001 Philco Electronic Circuit Master
- No. 7070 Philco RF Signal Generator
- No. 5072 Philco Crosshatch Generator
- No. 7030 Philco Dynamic Tester
- No. 7019 Philco Junior Scope

COMPLETE PHILCO TEST EQUIPMENT LINE

Primarily, to provide for the needs of radio's largest, best informed group of service technicians—the 25,000 members of Philco Service—Philco engineers have created this complete line of precision instruments for radio measurements, in compact, portable, inexpensive form. The unique, practical advantages of Philco equipment are widely known today, wherever electronic devices are used—in communications, laboratories, and industrial plants. If you use, or plan to use, electronics in your work, get the facts now about Philco Test Equipment.

PHILCO CORPORATION • Philadelphia 34, Pa.

RADIO "TRAFFIC COP" with a good heart!



Operating where audio frequencies crowd the thoroughfares, variable attenuators assure precision volume control in speech input equipment for radio consoles, sound motion pictures, public address systems, and television.

With a "traffic cop" of this type in each microphone circuit of a multi-microphone set-up, input volume of one unit can be gradually faded out while that of another is increased; close-up and background program effects can be reproduced with whatever degree of contrast is desired; and the resultant mixing of all microphone inputs can be precisely and smoothly handled, through a master gain control, to meet all variations in program tonal intensity.

Since impedance of a circuit is kept constant while volume is changed, uni-

form performance is obtained without sacrifice of quality.

To assure topnotch results, the maker—Daven Company of Newark, N. J.—specifies that *all* its resistors, "standards in the industry", be wound with wire drawn from Driver-Harris electrical heat and corrosion-resisting alloys: Nichrome*V, Nichrome*, Advance*, D-H Manganin and the newly developed 331 Alloy which has very high specific resistance and a very low temperature coefficient of resistance.

If *you* require electrical resistance wire of outstanding uniformity, high stability, and long life, be guided by the example of Daven, whose products are used the world over, and have Driver-Harris supply your needs. For D-H alloys are the very heart of good electrical equipment of all kinds. Send us your specifications.



Nichrome is Manufactured only by

Driver-Harris Company
HARRISON, NEW JERSEY

BRANCHES: Chicago, Detroit, Cleveland, Los Angeles, San Francisco, Seattle
Manufactured and sold in Canada by
The B. GREENING WIRE COMPANY, LTD., Hamilton, Ontario, Canada

*T.M. Reg. U. S. Pat. Off.

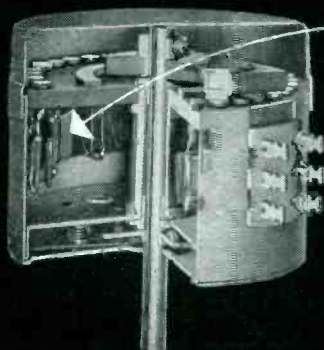

Dependable "heart" of Daven Attenuators is D-H electrical resistance wire.

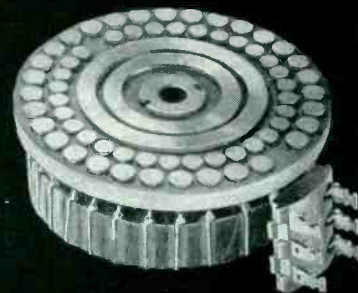
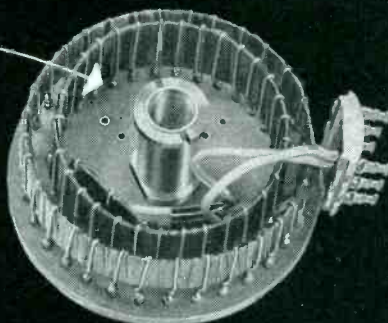

Silver alloy contacts assist in improving performance.

Notably compact, Daven Rotary-type Variable Attenuators are made in sizes from 1 3/4" to 2 3/4" outside diameter. Standard units, giving up to 45 steps of attenuation, are available with built-in cueing control, enabling recordings, transcriptions, remote or network programs to be cued without necessity for auxiliary switching mechanism. Accuracy of resistance: from 0.1% up.

THEY'RE BETTER BECAUSE ...



the
EIMAC
4-65A



APPLIED RESEARCH by Eimac engineers has produced a thoriated tungsten filament with ample reserve emission. Its instant heating characteristics make the 4-65A well adapted to mobile application.

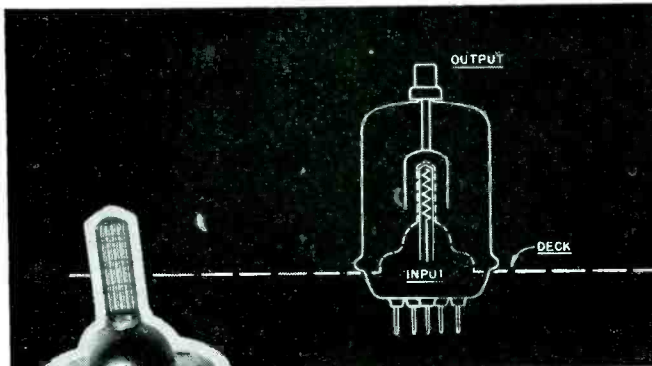

SPECIALLY DESIGNED screen grid effectively shields input and output circuits, within the tube, without excessive screen power. All internal structures are self supporting without the aid of insulating hardware.

These are but some of the features that combine to make the Eimac 4-65A a better tetrode. It is unexcelled in its category as a power amplifier, oscillator or modulator. For example, in typical operation as a power amplifier or oscillator (class-C telegraphy or FM telephony) one tube with 1500 plate volts will supply 170 watts of output power with less than 3 watts of driving power. A complete comprehensive data sheet on the 4-65A has just been released. Write for your copy today.

EITEL-McCULLOUGH, INC.
204 San Mateo Ave., San Bruno, California

Export Agents: Frazer & Hansen, 310 Clay Street, San Francisco 11, California

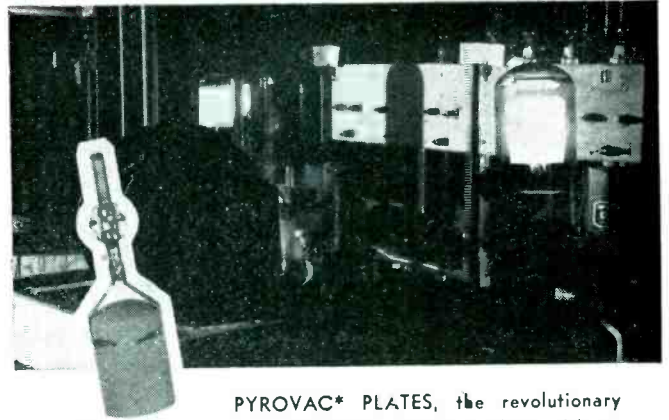

PYROVAC* PLATES, the revolutionary Eimac development, withstand excessive abuse. Manufactured by an advanced technique, these plates can handle momentary overloads in excess of 1000%, consequently they contribute appreciably to the tube's life.

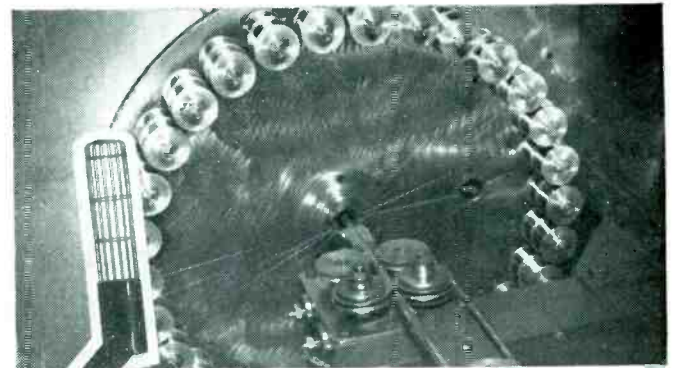

EIMAC PROCESSED GRIDS, manufactured by an exclusive technique, impart a high degree of operational stability. Both primary and secondary emission are controlled.



CONTROLLED PRODUCTION practices include a slow oven-anneal to remove the last vestige of residual strains, and four to eight hours of testing under severe VHF conditions.

*Trade Mark Reg. U. S. Pat. Off.

Follow the Leaders to

Eimac
REG. U. S. PAT. OFF.
TUBES

The Power for R-F

INDIANA PERMANENT MAGNETS MAY BE YOUR ANSWER, TOO

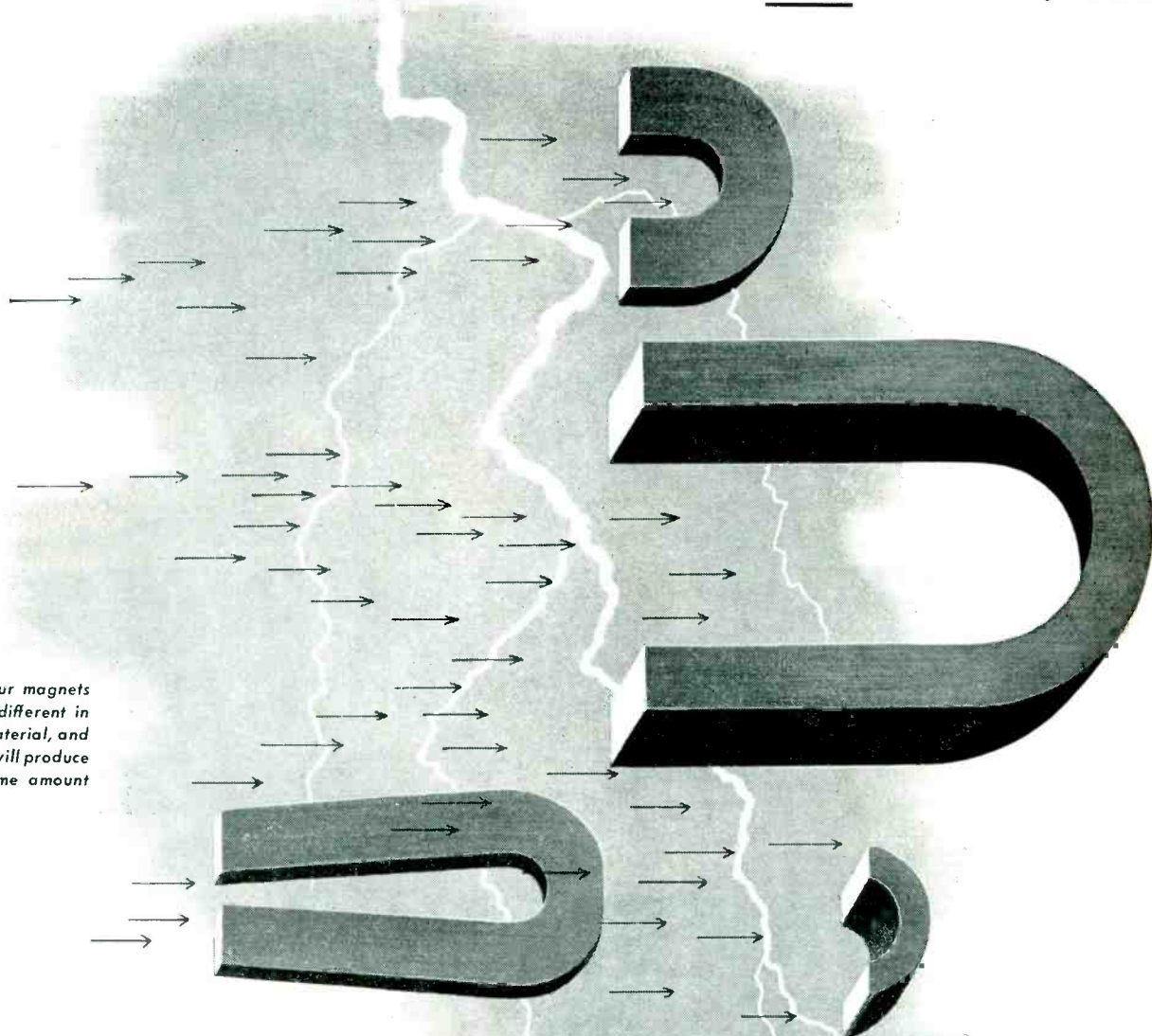

Each of the four magnets shown here is different in size, weight, material, and price; yet each will produce exactly the same amount of energy.

"PACKAGED ENERGY" SAVES SPACE, CUTS COSTS

INDIANA permanent magnets fit your need like a doctor's prescription—the right material, the right design, the *right* magnets to *do your job best*.

When you buy *Indiana* permanent magnets, you buy *product improvement* . . . new and higher efficiency . . . new versatility . . . new economy. Today, *Indiana* magnets are performing operations that were impractical only a few years ago—actually replacing many mechanical and electrical devices—and with less weight, less bulk, *lower cost*.

For example, certain radar magnets of Alnico originally weighed 14 pounds. Through *redesign* by *Indiana*, their size was reduced materially and their weight cut to 3½ pounds. Both were of identical material; both produced the same energy. The substantial savings in weight and cost were accomplished wholly by a change in design. Consultation with our engineers may result in similar savings for you.

NEW! BOOKLET NO. 4-E11— TELLS ALL ABOUT PERMANENT MAGNETS. A NOTE ON YOUR COMPANY LETTER-HEAD WILL BRING YOU A FREE COPY.



Indiana is the *only* manufacturer of all types of commercially used permanent magnet alloys. Continuous research and production control assure top quality and uniformity of *all* your *Indiana* permanent magnets, regardless of size or quantity. Call on our Special Design Service in solving *your* problems.



THE INDIANA STEEL PRODUCTS COMPANY

PRODUCERS OF "PACKAGED ENERGY"

6 NORTH MICHIGAN AVENUE • CHICAGO 2, ILL.

SPECIALISTS IN PERMANENT MAGNETS SINCE 1908

PLANTS: VALPARAISO, INDIANA; CHAUNCEY, N. Y.

FREED

for Quality & Performance Use
FREED INSTRUMENTS & COMPONENTS!



NULL DETECTOR

Freed Model 1140 is a high gain null indicator for bridge measurements, providing visual null indications or aural indications when used in conjunction with head-phones. The unit may also be used as a high gain amplifier for general laboratory work.

INPUT IMPEDANCE: 1 Megohm in parallel with 25 mmf.

GAIN: 98 db with 1 megohm load (6 mmf. shunt capacity), down 1.5 db at 25,000 cycles, down 5 db at 50,000 cycles, down 2 db at 20 cycles.

NULL DETECTOR SENSITIVITY: At 1 Kc 100 microvolts will give a 15% meter deflection.

SELECTIVE AMPLIFIER: 23 db second harmonic attenuation at 60, 400 and 1000 cycles.

OUTPUT IMPEDANCE: Approximately 50,000 ohms.

Freed Model 1110

INCREMENTAL INDUCTANCE BRIDGE

IMPEDANCE RANGE: One millihenry to 1000 henries in five ranges. Inductance values are read directly from a four dial decade and multiplier switch. This range can be extended to 10,000 henries by the use of an external resistance. Superimposed D.C. up to 2 Amp.

INDUCTANCE ACCURACY: Within plus or minus 1% through the frequency range from 60 to 1000 cycles.



FREED HERMETICALLY SEALED CLASS A GRADE 1 COMPONENTS ARE APPROVED for JAN—T—27 SPECIFICATIONS.

POWER TRANSFORMERS
FILTER REACTORS
AUDIO TRANSFORMERS
SUPERSONIC TRANSFORMERS
WAVE FILTERS
HI-Q COILS
DISCRIMINATORS
SATURABLE REACTORS
PULSE TRANSFORMERS
CHARGING CHOKES

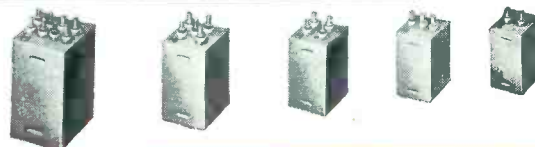

FREED

TRANSFORMER CO., INC.
Dept. NE 72-78 Spring Street
New York 12, N. Y.

Special CAPACITORS

... engineered by **AEROVOX**

Aerovox Series 20 Hyvol impregnated and filled capacitors in ratings up to 50,000 v. in hermetically sealed welded steel cases.

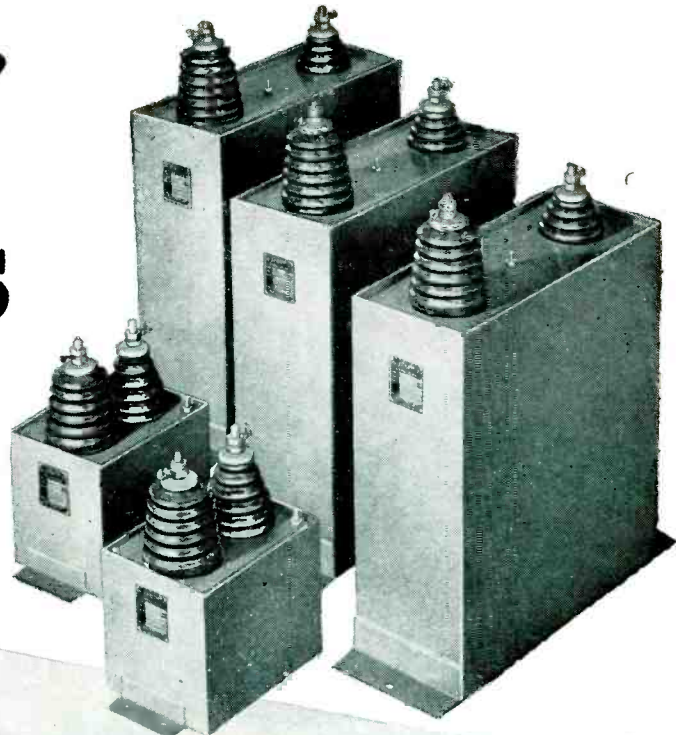

Aerovox Series 26 stack-mounting Hyvol impregnated and filled capacitors in ratings up to 150,000 v. Laminated bakelite cases. Cast-aluminum terminal ends.

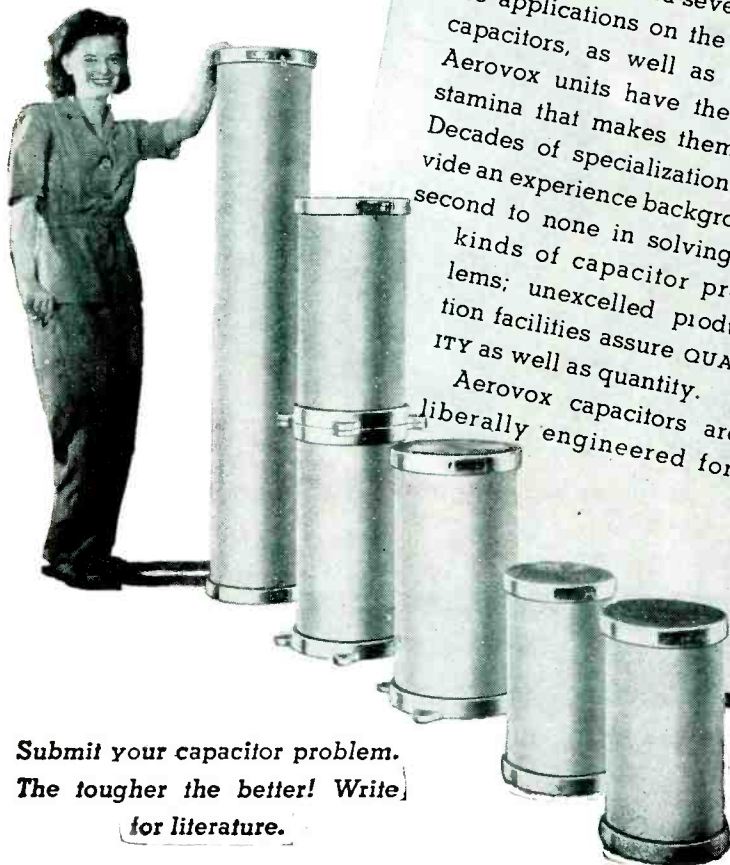

● For those extra-severe-service applications on the largest capacitors, as well as others, Aerovox units have the extra stamina that makes them last. Decades of specialization provide an experience background second to none in solving all kinds of capacitor problems; unexcelled production facilities assure QUALITY as well as quantity. Aerovox capacitors are liberally engineered for their individual applications. Special multi-layer capacitor tissues... long-life, non-inflammable Hyvol impregnant and fill... constant filtration and testing of impregnant as regular production routine... thorough evacuation and impregnation... positive hermetic sealing—these facts of Aerovox craftsmanship spell long, trouble-free service. Aerovox capacitors in daily use speak for themselves. No finer capacitors are built. Aerovox engineers stand ready to meet your most severe requirements.

Submit your capacitor problem. The tougher the better! Write for literature.



FOR RADIO-ELECTRONIC AND INDUSTRIAL APPLICATIONS

AEROVOX CORPORATION, NEW BEDFORD, MASS., U.S.A.

SALES OFFICES IN ALL PRINCIPAL CITIES • Export: 13 E. 40th St., NEW YORK 16, N. Y.

Cable: 'ARLAB' • In Canada: AEROVOX CANADA LTD., HAMILTON, ONT.

No value equal to it...

Model 260 Volt-Ohm-Milliammeter

There's good reason why this is the world's most popular high sensitivity volt-ohm-milliammeter. In every part, from smallest component to overall design, no competing instrument can show superiority. It outsells because it outranks every similar instrument. And in the Simpson patented Roll Top safety case, shown here, it brings you important and exclusive protection and convenience.

- in staying accuracy
- in functional design
- in useful ranges
- in sensitivity
- in ruggedness
- in precision

Sub-Panel Assembly—Strong, Simple, Accessible

with cover over resistor pockets removed to show design



The ruggedness, the simplicity of design, and the consequent accessibility of components are shown here. Molded of sturdiest bakelite, the sub-panel provides separate pockets for resistors. This separation makes for orderly assembly, highest possible accessibility, and added insulation for preventing shorts. All connections are short and direct. Cable wiring is eliminated. Each battery has its own compartment, again increasing accessibility.



The New Simpson Switch Mechanism. You will find no other switch mechanism on the market like this Simpson switch. It is built of molded bakelite discs. Unusually sturdy contacts, of heavy stamped brass, silver-plated for superior conductivity are molded permanently into each disc. They can never come loose, never get out of position. When the discs are assembled into the complete switch, these contacts are self-enclosed against dust. Danger of shorts is automatically eliminated. As the switch is rotated from range to range, the contact is always positive and unvarying.

A ball-and-spring mechanism positions the switch at the selected range by a 3-point pressure. Switch is thus held securely in place, yet smoothly repositions to each new range. This mechanism is also self-enclosed against dust in a bakelite housing.



A flick of the finger opens or closes the Roll Top front.

High voltage probe (25,000 volts) for TV, X-ray and other high voltage tests also available

RANGES

- 20,000 Ohms per Volt D.C., 1,000 Ohms per Volt A.C.
- Volts: A.C. and D.C.: 2.5, 10, 50, 250, 1000, 5000
- Output: 2.5, 10, 50, 250, 1000
- Milliamperes, D.C.: 10, 100, 500
- Microamperes, D.C.: 100
- Ampere, D.C.: 10
- Decibels (5 ranges): -10 to +52 D.B.
- Ohms: 0-2000 (12 ohms center), 0-200,000 (1200 ohms center), 0-20 megohms (120,000 ohms center).
- Model 260, Size: 5 1/4" x 7" x 3 1/2" \$38.95
- Model 260 in Roll Top Safety Case, as shown. \$45.95
- Size: 5 3/8" x 7" x 4 3/4"

Ask your jobber or write for complete descriptive literature.

Simpson

INSTRUMENTS THAT STAY ACCURATE

SIMPSON ELECTRIC COMPANY
5200-5218 W. Kinzie St., Chicago 44, Ill.
In Canada: Bach-Simpson, Ltd., London, Ont.

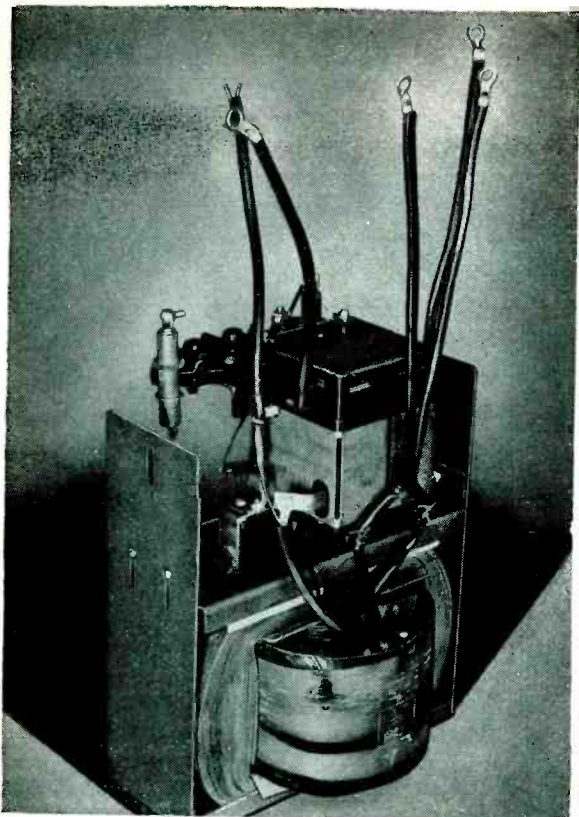

This interior view of the Kuhlman 5kva, 4160-120/240 volt, single phase, Oil Immersed Self Cooled distribution transformer shows secondary breaker, protective links, and BI Core Construction. Secondary breaker mechanism normally closes a signal lamp circuit at a coil temperature of 105° C, and trips the breaker at 125° C. Protective links between primary winding and each line terminal disconnect the transformer from the line in the event of transformer failure. BI Core Construction, introduced by Kuhlman, pioneered use of low loss steel in distribution transformers. Leads are insulated and protected by Natvar 400 Extruded Vinyl Tubing.

KUHLMAN OISC TRANSFORMER LEADS

are protected with

NATVAR 400

Distribution transformers are now more vital links in the distribution system than ever before. Not only has power consumption reached a new peak, but the load itself is more widely distributed.

Completely Self-Protecting transformers manufactured by Kuhlman Electric Company, Bay City, Michigan, combine sound design with proven accessories. The result is a self-contained unit.

Natvar 400 Extruded Vinyl Tubing, approved for 105° C is used to insulate and protect the leads because it meets operating temperature requirements, and in addition, has uniformly superior resistance to oil.

Prompt deliveries can be made either from a nearby wholesaler's stock or direct from our own. Full Underwriters' report on request.



Natvar Products

- Varnished cambric—straight cut and bias
- Varnished cable tape
- Varnished canvas
- Varnished duck
- Varnished silk
- Varnished special rayon
- Varnished Fiberglas cloth
- Silicone coated Fiberglas
- Varnished papers
- Varnished tubings and sleeveings
- Varnished identification markers
- Lacquered tubings and sleeveings
- Extruded vinyl tubing and tape
- Extruded vinyl identification markers

Ask for Catalog No. 21

THE NATIONAL VARNISHED PRODUCTS

Corporation

TELEPHONE
RAHWAY 7-2171

CABLE ADDRESS
NATVAR: RAHWAY, N. J.

201 RANDOLPH AVENUE



WOODBIDGE NEW JERSEY

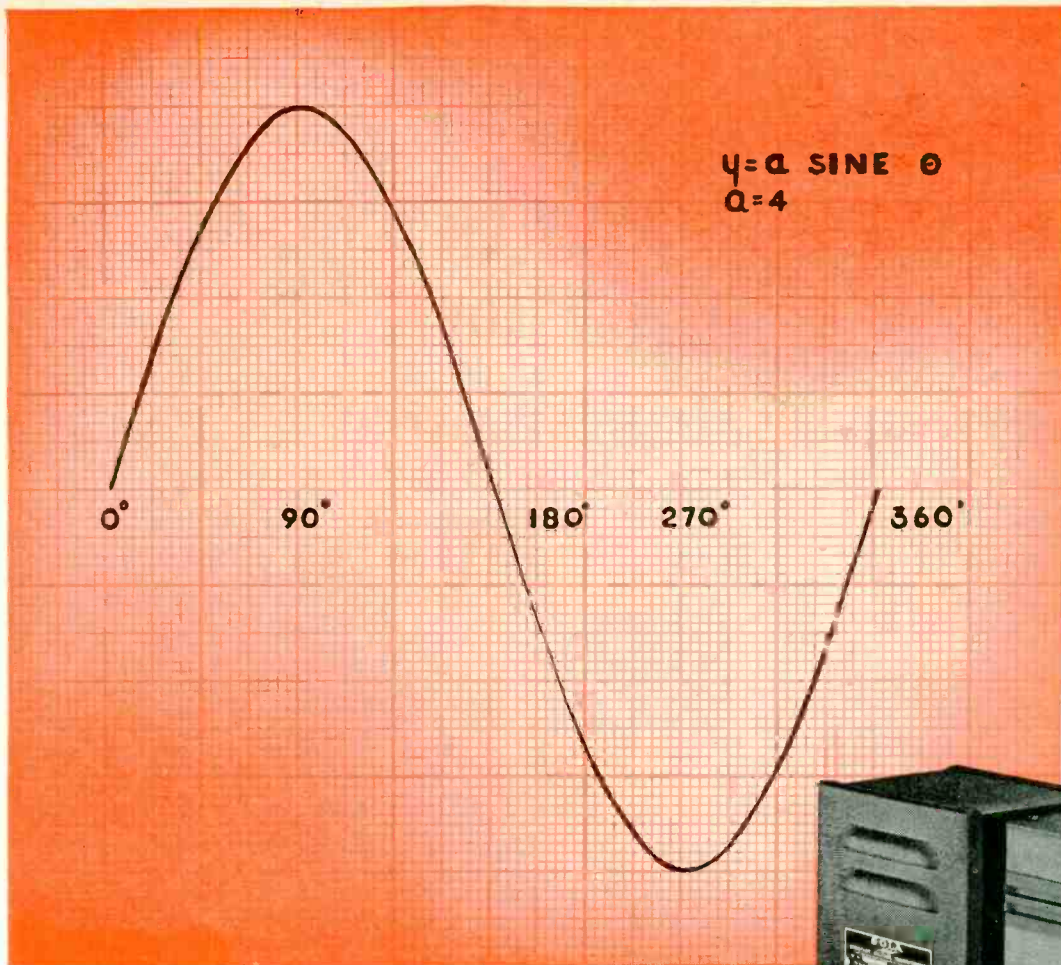

CONSTANT VOLTAGE with low harmonic distortion



TYPE CVH, an important newcomer in a famous line—a SOLA CONSTANT VOLTAGE Transformer designed for use with equipment that requires a source of undistorted voltage. These new transformers, available in 250, 500 and 1,000 VA capacities, provide all of the voltage stabilizing characteristics of the standard SOLA Constant Voltage Transformer, with less than 3% harmonic distortion of the output voltage wave.

Since the output voltage wave is essentially sinusoidal, these transformers may be used for the most exacting applications such as general laboratory work, instrument calibration, precision electronic equipment or other equipment having elements which are sensitive to

power frequencies harmonically related to the fundamental.

As in all SOLA Constant Voltage Transformers the regulation is automatic and instantaneous. There are no moving parts, no manual adjustments and every unit is self-protecting against short circuit.

Type CVH represents an outstanding advance in automatic voltage regulation and an important contribution to precise electronic equipment.

WRITE FOR THESE BULLETINS

DCVH-138—complete electrical and mechanical characteristics of the new Type CVH Constant Voltage Transformers.

DCV-102—complete engineering handbook and catalog of standard Constant Voltage Transformers available for remedial or built-in applications.

SOLA

Constant Voltage
TRANSFORMERS

Transformers for: Constant Voltage • Cold Cathode Lighting • Airport Lighting • Series Lighting • Fluorescent Lighting • Luminous Tube Signs
Oil Burner Ignition • X-Ray • Power • Controls • Signal Systems • etc. • SOLA ELECTRIC COMPANY, 4633 W. 16th Street, Chicago 50, Illinois

Manufactured under license by: ENDURANCE ELECTRIC CO., Concord West, N. S. W., Australia • ADVANCE COMPONENTS LTD., Walthamstow, E., England
UCOA RADIO S.A., Buenos Aires, Argentina • M. C. B. & VERITABLE ALTER, Courbevoie (Seine), France

BIG RUNS

(large or small PARTS)

are everyday business

SILL CAP FOR
RAILWAY CARS

at **RICHARDSON**
Manufacturers of

Molded INSUROK R. T. M.

Capacity for big runs is only one of the advantages offered in custom molding by The Richardson Company. A blend of long experience, able engineering, plant capacity and all-around production efficiency helps give you a quality job at a price that's right. Perhaps you can use these advantages to your advantage.

The **RICHARDSON COMPANY**

GENERAL OFFICES: LOCKLAND, OHIO FOUNDED IN 1858

Sales Headquarters: MELROSE PARK, ILLINOIS

CLEVELAND - DETROIT - INDIANAPOLIS - MILWAUKEE - NEW BRUNSWICK, (N. J.) - NEW YORK - PHILADELPHIA - ROCHESTER - ST. LOUIS

here's
on-the-job proof
of Westinghouse
Instrument
Performance

*where reliability
 and readability
 really count*

Westinghouse instrument specialists are available in the field for consultation on your instrument problems. Call your nearest Westinghouse office, or write Westinghouse Electric Corporation, P. O. Box 868, Pittsburgh 30, Pa.

Send for Booklet B-2209-A, Communication Instrument Booklet B-3283, or Switchboard Instrument Booklet B-3363.

Radio stations can take no chances on "outages"—time off the air is costly. For split-second timing, efficiency, and continuity, all vital operating information must be readily available to the control engineer at a glance.

For these reasons, instruments of unflinching performance and quick readability are a *must*. The Westinghouse instruments at KMOX solved these problems. They also provide co-ordinated styling and smart appearance.

What are YOUR electrical measuring problems?

Would they include—reliable performance . . . styling . . . size . . . readability or different types of service . . . portable . . . switchboard . . . panel . . . recording?

The vast lines of Westinghouse electrical measuring instruments provide you with the answers to all of these problems. Every Westinghouse instrument is backed up by more than 60 years of skill, "know-how", and experience in every field of industry.

J-40362

Westinghouse Instruments Also Provide You With

- Dials that stay white under all conditions
- Magnets that stay permanent
- Pivots with high shock capacity and low friction
- Springs that remain constant for life
- Quick delivery of more different ratings and types
- Complete Nationwide Service

YOU CAN BE SURE... IF IT'S

Westinghouse
 PLANTS IN 25 CITIES... OFFICES EVERYWHERE



Electrical Measuring Instruments for ANY Job

New 50,000-watt transmitter at station KMOX, St. Louis. This station is one of the important links in the Nation's vital educational, news, and entertainment industry.

S

WAX AND COMPOUND

OLVING PROBLEMS IS OLD STUFF

AT MITCHELL-RAND . . .



With our background of 59 years experience in solving the WAX and COMPOUND problems of the electrical industry, we no longer think it strange that there are so many different and unique specifications and requirements for a WAX and COMPOUND to meet. In these 59 years, more than 3500 WAXES and COMPOUNDS were developed . . . and almost daily a new condition arises calling for a special formula. It was just such a challenge that enabled us to produce the latest in Mitchell-Rand's large line of WAXES and COMPOUNDS—#1366EX: here is a CAPACITOR END SEAL with characteristics, most unusual—check them and see if your electrical apparatus won't benefit from its use.

. . . and no matter how difficult or involved your insulating and impregnating wax or compound problems are . . . bring them to Mitchell-Rand, the Electrical Insulation Headquarters since 1889.

1366EX CAPACITOR END SEAL

Cold Flow	238/243° F
S. P. (R&B)	250/255° F
Pauring Temp.	350/400° F
Color	Tan
Adhesion	Satisfactory
Penetration 77/100/5	0
Chloride Free	Yes
Spec. Grav.	1.55
Flash Point	450° F

FREE FOR THE ASKING . . .

YOUR'S FOR THE ASKING . . .

is this COMPOUND DATA BOOK. The latest work of its kind, it is a comprehensive manual containing all the data, facts and figures, physical characteristics, test methods, active formulas and general applications for Mitchell-Rand's extensive line of Compounds, Waxes, etc. It's free upon written request.

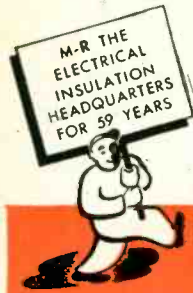

M-R COMPOUNDS

RESIST high voltage breakdown . . . salt spray atmosphere . . . humidity . . . cracking or flaking . . . acids and alkalis.
HAVE excellent flexibility and adhesive qualities . . . high cold flow and good thermal conductivity. **MORE THAN 3500 FORMULAS**

M-R WAXES

PENETRATE fibre . . . floss . . . bakelite . . . paper and cloth.
HAVE low viscosity . . . high surface tension . . . good electrical characteristics.

MITCHELL-RAND INSULATION CO. Inc.

51 MURRAY STREET · Cortlandt 7-9264 · NEW YORK 7, N. Y.

A PARTIAL LIST OF M-R PRODUCTS: FIBERGLAS VARNISHED TUBING, TAPE AND CLOTH · INSULATING PAPERS AND TWINES · CABLE FILLING AND POTHEAD COMPOUNDS · FRICTION TAPE AND SPLICE · TRANSFORMER COMPOUNDS · FIBERGLAS SATURATED SLEEVING · ASBESTOS SLEEVING AND TAPE · VARNISHED CAMBRIC CLOTH AND TAPE · MICA PLATE, TAPE, PAPER, CLOTH, TUBING · FIBERGLAS BRAIDED SLEEVING · COTTON TAPES, WEBBINGS AND SLEEVINGS · IMPREGNATED VARNISH TUBING · INSULATED VARNISHES OF ALL TYPES · EXTRUDED PLASTIC TUBING

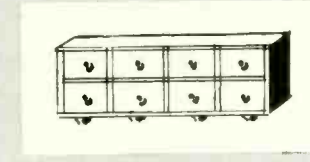
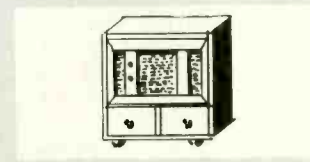
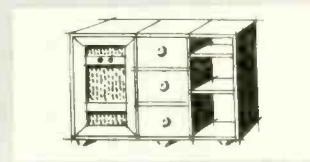
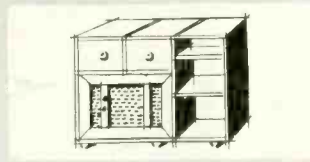
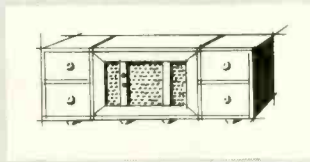
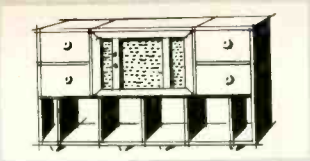

Jensen Customode

Customode is the answer to the ever expanding requirements of audio-video equipment. Today, you may install a 15" speaker, communications receiver, tuner, and a record changer. Tomorrow, you can add a television set, a pick-up for Micro-groove records, and a record cabinet. The illustrations show only a few of hundreds of cabinet variations for Home Entertainment Centers. Designed by leading furniture stylists and electronics engineers, Customode's "building block" versatility enables you to create your own layouts as you wish, when you wish.

Write today for literature and scale cut-up illustrations. Jensen Manufacturing Company, 6607 S. Laramie Ave., Chicago 38, Illinois.



Now! Specify

KENYON

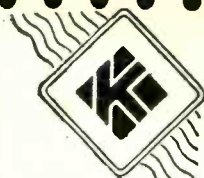

KENYON one of the oldest names in transformers, offers high quality specification transformers custom-built to your requirements. For over 20 years the KENYON "K" has been a sign of skillful engineering, progressive design and sound construction.

KENYON now serves many leading companies including: Times Facsimile Corporation, Western Electric Co., General Electric Co., Schulmerich Electronics, Sperry Gyroscope Co., Inc.

Yes, *electronification* of modern industrial machinery and methods has been achieved by KENYON'S engineered, efficient and conservatively rated transformers.

For all high quality sound applications, for small transmitters, broadcast units, radar equipment, amplifiers and power supplies — Specify KENYON! Inquire today for information about our JAN approved transformers.

Check Your Requirements

"T" LINE TRANSFORMERS HERMETICALLY SEALED TRANSFORMERS "A" LINE TRANSFORMERS

- | | |
|---------------------------|----------------------------------|
| ✓ PLATE TRANSFORMERS | ✓ INPUT & OUTPUT TRANSFORMERS |
| ✓ FILAMENT TRANSFORMERS | ✓ SPECIAL FREQUENCY TRANSFORMERS |
| ✓ REACTORS | ✓ ISOLATION TRANSFORMERS |
| ✓ CHOKES | ✓ AUDIO TRANSFORMERS |
| ✓ MODULATION TRANSFORMERS | ✓ HUMBUCKING TRANSFORMERS |
| ✓ INTERSTAGE TRANSFORMERS | ✓ AUTO TRANSFORMERS |

Now — for the first time in any transformer catalog, KENYON'S new modified edition tells the full complete story about specific ratings on all transformers. Our standard line saves you time and expense. Send for the latest edition of our catalog now!

SEND FOR OUR CATALOG NOW!

KENYON Transformer Co., Inc.
840 Barry Street, New York 59, N. Y.

Send me the latest edition of your new catalog without obligation

Name..... Address.....

Position..... City.....

Company..... State.....

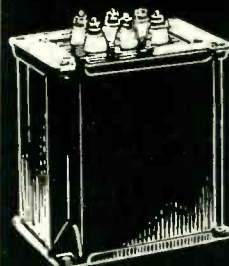
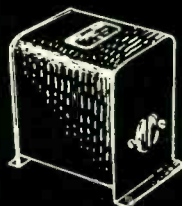
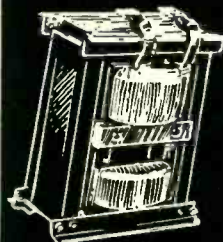
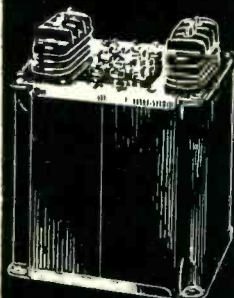
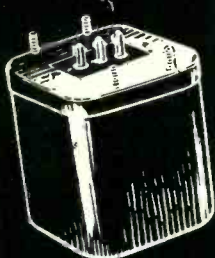
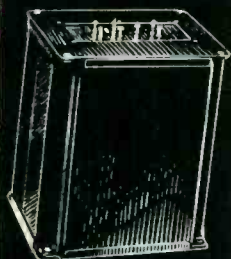

KENYON TRANSFORMER CO., Inc. 840 BARRY STREET
NEW YORK 59, N. Y.

Improved Efficiency in Plastic Molding Machines

Rockford's
Prize Winning Design
uses a **LORD**
Vibration Control
System

THE outstanding design features of the Rockford Hy-Jector Automatic Molding Machine won one of the five equal awards in an annual product design contest.

A Lord Vibration Control System is an important part of Rockford's design. Here's what Rockford says:

"In attempting to incorporate the maximum possible tube life and protection for the other components of the High Frequency R. F. Generator used in the Rockford Hy-Jector Automatic Molding Machine for Thermosetting Materials, we chose the Lord Mountings because of their superiority in the field of Vibration Control. They have proven themselves in our application."

This is another example of improved product performance with a Lord Vibration Control System.

Bulletin 900 is a complete outline of Lord products and services. Write for it today.

LORD MANUFACTURING CO., ERIE, PA.

Canadian Representative: Railway & Power Engineering Corp., Ltd.

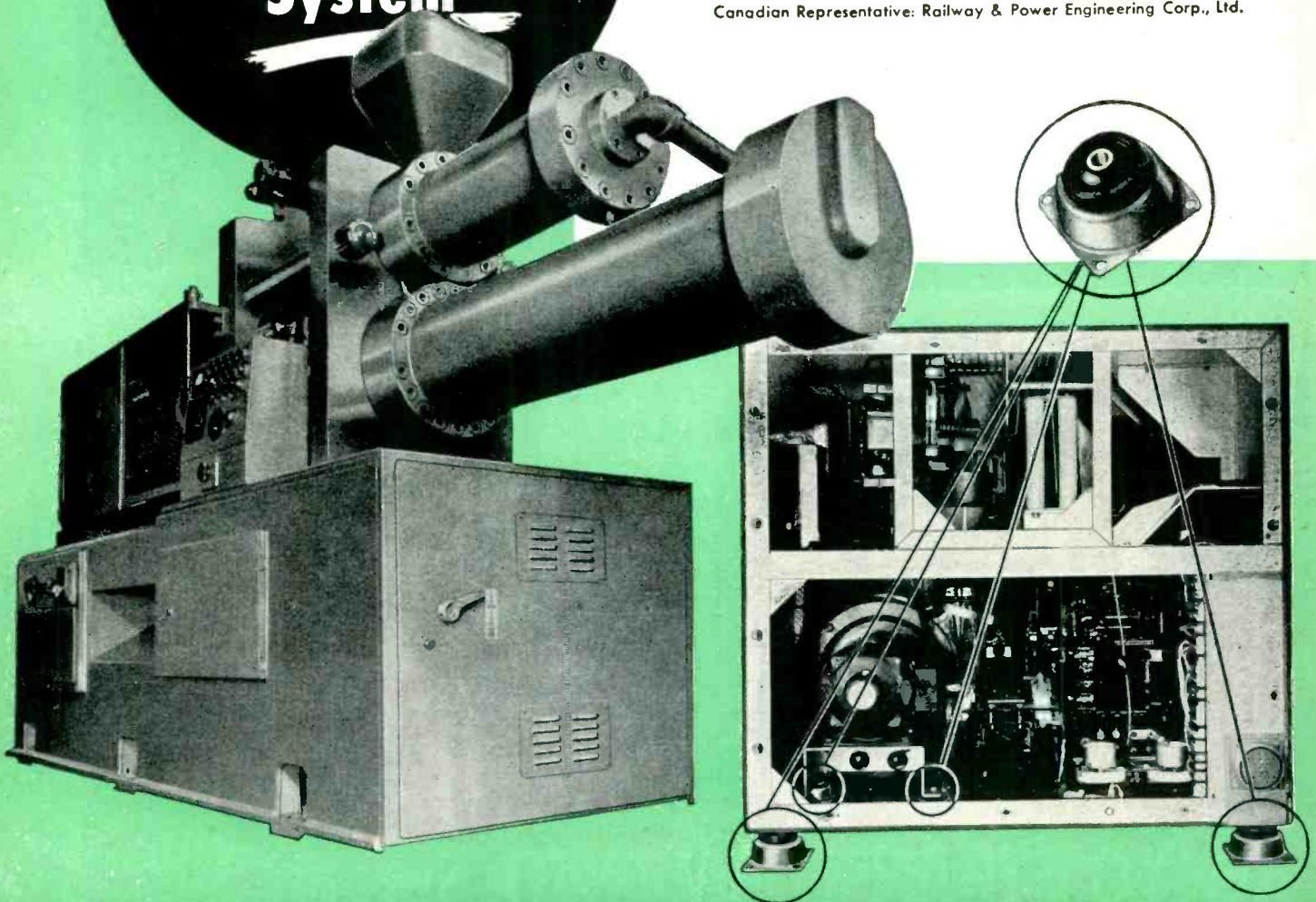

LORD

Vibration Control Systems

The entire cabinet containing the dielectric heating unit is mounted on Lord Holder Type Plate Form Mountings, and the blower within the cabinet is separately mounted on smaller mountings of the same type.



When it comes to fitting Budgets as well as Circuits . . .



you can't beat the effectiveness of
STRUTHERS-DUNN'S 5,348 RELAY TYPES

HERE ARE RELAYS FOR ALMOST EVERY CONTROL APPLICATION —
 Data Bulletins available on any of these general types

- | | | |
|---|--|---|
| SMALL RELAYS
Midget—General Purpose—Vending Machine | POWER RELAYS
Large Power—Mercury Swing
Mercury Clapper—Nutcracker
(D-C)—High Voltage | SENSITIVE RELAYS
Low Power—
Snap Action |
| INSTRUMENT-CONTROLLED RELAYS | MEMORY RELAYS (Mechanical Latch)
Industrial Types—Vibration-Resistant Types | |
| SEQUENCE RELAYS
Ratchet Types—
Multipole Types | SPECIAL-PURPOSE RELAYS
Lamp Control—Polarized—Close
Differential—Overload Motor
Reversing—Telephone Signalling | TIMING RELAYS
Inertia—Thermal
Motor-Operated |

With 5,348 standard types to choose from . . .

With each type subject to many electrical and mechanical adaptations . . .

Struthers-Dunn can readily match the relay requirements of both your circuit and your budget. Prices are well in line—and, by way of good measure, you get all of the advantages of well designed, sturdily constructed relays that are specifically "tailored" for your particular application.

STRUTHERS-DUNN, INC., 150 N. 13th St., Philadelphia 7, Pa.

STRUTHERS-DUNN

HOW MANY
db?

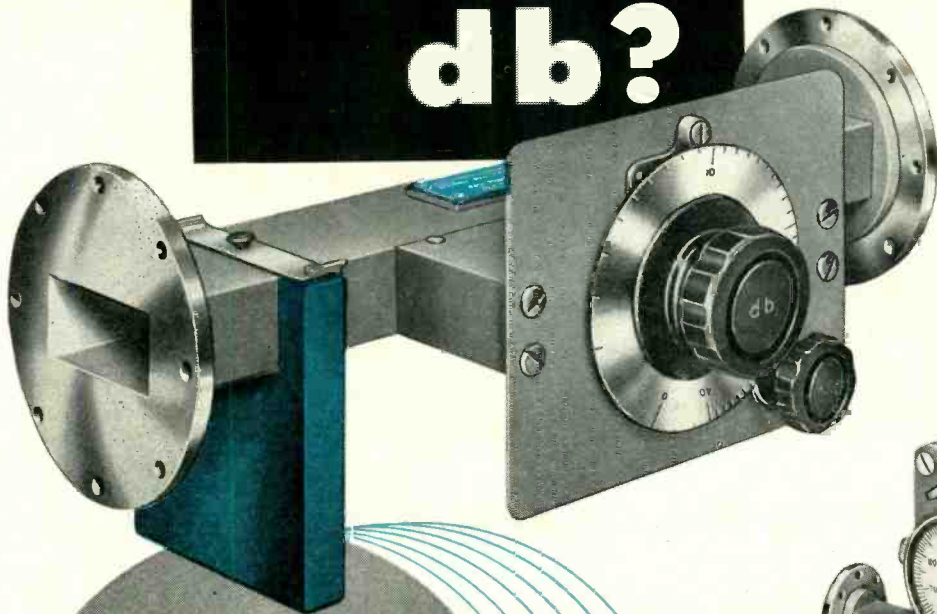

.. AT 5,000
MEGACYCLES?

.. AT 25,000
MEGACYCLES?

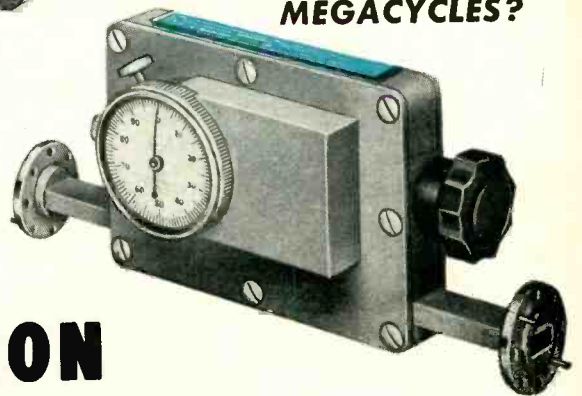

PRD

PRECISION VARIABLE ATTENUATORS

Features:

METALLIZED-GLASS
ATTENUATING ELEMENTS
PRECISE AND PERMANENT
CALIBRATION
BROADBAND
CHARACTERISTICS
NEGLIGIBLE INSERTION LOSS
BACKLASH-FREE
VERNIER DRIVE
LOW REFLECTION
WELL SHIELDED CASING

These attenuators, utilizing metallic-film-on-glass resistive elements, are of the most advanced design now available. Broadband matching, minimum frequency sensitivity, and constancy of attenuation with time, are but a few of the advantages which this technique affords. Casing designs available cover requirements from that of a simple power control attenuator to that of a precisely calibrated secondary standard.

Metallized glass attenuators are an important type of microwave measurement component in the complete PRD line. Available also are precision slotted sections and probes, impedance matching devices, frequency meters and standard cavities, and all of the other items which make up a complete measurements bench. An illustrated catalog and price list may be obtained by writing to Department E-7, on company letterhead.

66 COURT STREET
BROOKLYN 2, N. Y.



Polytechnic **RESEARCH
& DEVELOPMENT COMPANY, Inc.**

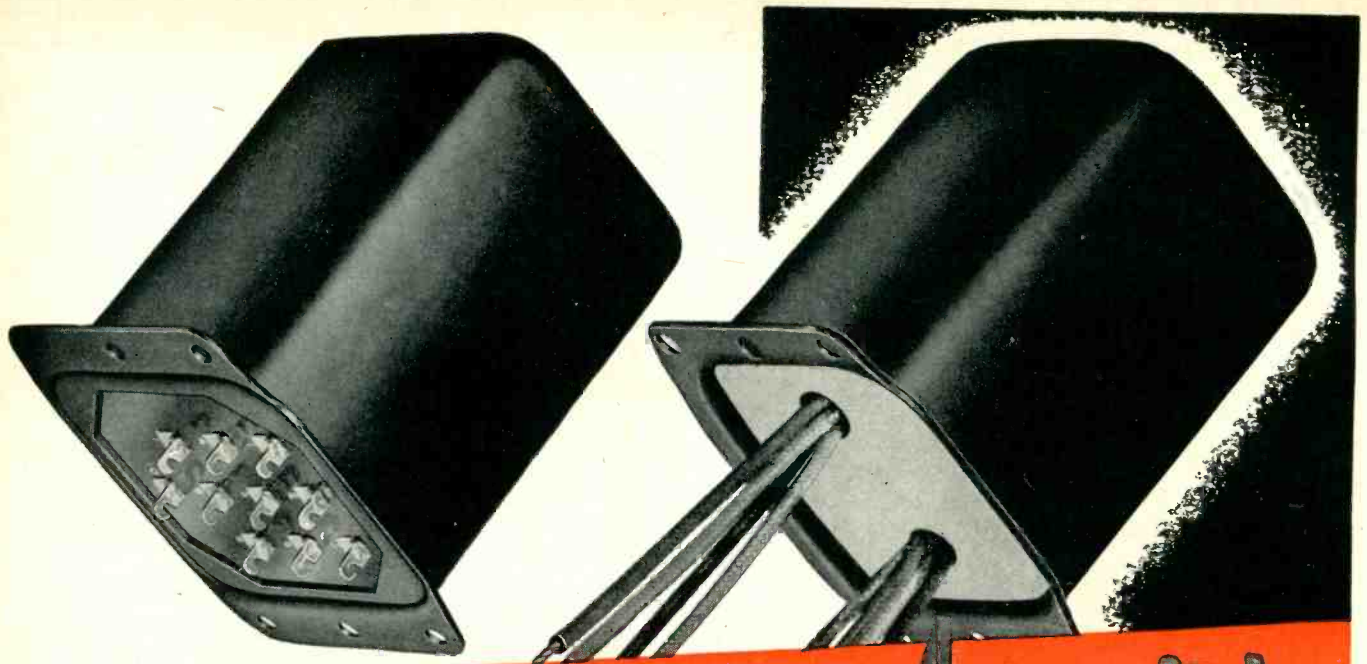

note The New Look in Power Transformers

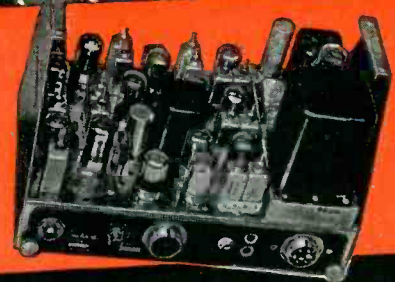

Typical Motorola FM two-way radiotelephone receiver utilizing Sealed in Steel Chicago Transformers.

With CT's Famous Sealed in Steel Construction

The clean, streamlined appearance and compactness of CT's new *Sealed in Steel* construction contribute immeasurably to the trim, precision-like effect of any electronic equipment.

In addition, CT Transformers provide "steel wall" protection against atmospheric moisture, efficient magnetic and electro-static shielding, unsurpassed strength and rigidity to withstand shock and vibration, and unusual convenience of mounting.

Two base styles are available for most of the units in this catalog line, one with clearly identified solder lugs in a phenolic terminal board, the other with RMA color coded leads, stripped and tinned for easy soldering.

The design of these new power transformers assures maximum performance with minimum physical size and minimum temperature rise in accordance with RMA standards.

The wide range of carefully selected ratings achieves maximum flexibility of application, close matching with today's preferred types of tubes, and conformance with all industry standards.

Write direct for catalog illustrating, describing and listing the complete line, or contact your nearest radio parts jobber at once.

PLATE AND FILAMENT SUPPLY TRANSFORMERS

Primary 117 Volts, 50-60 Cycles

Catalog Number	HIGH VOLTAGE SECONDARY		FILAMENTS			
	A.C. Volts	D.C. Output Ma.	D.C. Volts Output	Rectifier Volts Amps.	No. 1 Volts Amps.	No. 2 Volts Amps.
PC-55	270-0-270	55	260	5 2	6.3CT 2
PC-70	335-0-335	70	320	5 2	6.3CT 3
PC-85	330-0-330	85	320	5 2	6.3CT 3
PC-105	345-0-345	105	320	5 2	6.3CT 3.5
PC-120	375-0-375	120	380	5 3	6.3CT 4
PC-150	370-0-370	150	390	5 3	6.3CT 4	6.3CT 1
PC-200	385-0-385	200	390	5 3	6.3CT 4.5	6.3CT 1
For REACTOR INPUT SYSTEMS						
PR-55	350-0-350	55	260	5 2	6.3CT 2
PR-70	425-0-425	70	320	5 2	6.3CT 3
PR-85	440-0-440	85	325	5 2	6.3CT 3
PR-105	445-0-445	105	325	5 2	6.3CT 3.5
PR-120	500-0-500	120	400	5 3	6.3CT 4
PR-150	505-0-505	150	400	5 3	6.3CT 4	6.3CT 1
PR-200	520-0-520	200	410	5 3	6.3CT 4.5	6.3CT 1
PR-300	550-370-75-0 -75-370-550	300	425	5 6	6.3CT 5	6.3CT 1

Also available in the *Sealed in Steel* constructions:
FILTER REACTORS with current ratings to match power transformers above.
FILAMENT TRANSFORMERS to meet a wide range of modern tube requirements.

AUDIO TRANSFORMERS—Input, Output, Driver, and Modulation—that provide uniformly high fidelity response in three frequency ranges: 30-15,000 cycles, 50-10,000 cycles, and 200-3,500 cycles.

CHICAGO TRANSFORMER

DIVISION OF ESSEX WIRE CORPORATION

3501 ADDISON STREET • CHICAGO 18, ILLINOIS



Age-Resistant
Wire Keeps Your
Products Young
...and Keeps
Your Customers

SOLD!



Let's suppose you make a television set, a range, a waffle iron or some other electrical product . . . and Mrs. Jones buys one.



Her friends like its smooth modern design, dependable operation . . . and enthuse over its novel features.



But after awhile wire-trouble rears its ugly head, performance goes hay-wire, again . . . and again.



Then Mrs. and Mr. Jones tell all their friends, and you can say good-bye to a customer . . . and a lot of prospects.



1. Magnet Wire. 2. Firewall Hookup Wire. 3. Appliance Lead Wire. 4. A.V.C. Switch-board Wire. 5. Thermostat Control Wire.

TOUGH BREAK?
Maybe . . . but it could have been prevented with wire designed for years of dependable operation under even the most severe conditions. For many products that means *permanently insulated* Rockbestos wires, cables and cords.

Rockbestos wires, cables and cords—insulated with impregnated felted asbestos and other enduring materials — are the best insurance you can buy against wire-failure caused by heat, flame, fumes, grease, oil . . . and age.

WRITE TODAY — for your copy of the new No. 10-F Catalog, sectioned for easy reference to Appliance, Aircraft, Electronic, Fixture, Lighting and Magnet Wires; Apparatus Wires and Cables; Power and Control Cables.

ROCKBESTOS PRODUCTS CORP.

465 NICOLL ST., NEW HAVEN 4, CONN.

New York
Pittsburgh

Cleveland
St. Louis

Detroit
Los Angeles

Chicago
Oakland, Calif.

ROCKBESTOS



THE WIRE WITH PERMANENT INSULATION

See How Springs Stay Springy

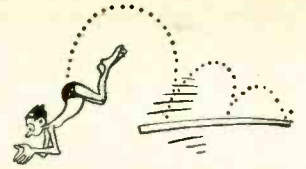

... despite high **HEAT** and active **CORROSION**
when made of **INCO NICKEL ALLOYS**



G. E. Automatic Toaster uses five Inco Nickel Alloy springs to insure long-time operation. Temperatures up to 500° F.

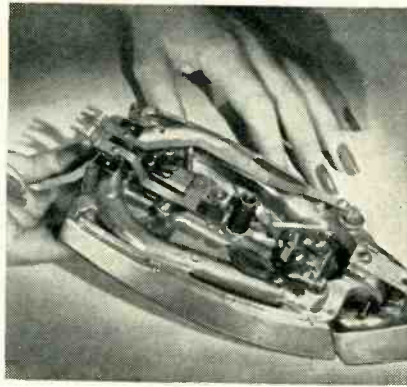

Yale & Towne "Tip Toe" Automatic Iron uses Inconel coil spring for the flexing arm of the sole plate. Corrosive steam here from damp clothes.



Westinghouse Sun Lamp uses "Z" Nickel springs to support quartz tube inside the lamp. Temperatures up to 750°.

**Look at these well-known appliances,
and consider the user-benefits
they offer the consumer**

How to provide for long-time strength and resiliency at elevated temperatures, particularly in the presence of corrosives, poses a problem. The springs in the appliances shown above withstand temperatures ranging from 500° to 750° F. Two operate in the presence of moisture. The springs in the fuse cutout switch shown here maintain their excellent spring properties even when subjected to salt and sulphurous atmospheres in heavy industrial areas.

Inco Nickel Alloy springs are particularly useful in applications where corrosion or high temperatures are present. Their fatigue-resistant properties are often of prime value, but most apparent where corrosion and heat are factors.

For example, consider the G. E. Automatic Toaster: The pop-up spring has to retain spring

properties after long exposure to temperatures up to 500° F. This and three similar springs subject to 400° F. are all made of Monel. The main switch spring, subject to only 300° F. requires close tolerances. If too thick, it might take a set. If too thin it would lack sufficient contact pressure. Full hard Inconel strip .012" x 3/8" solves this problem.

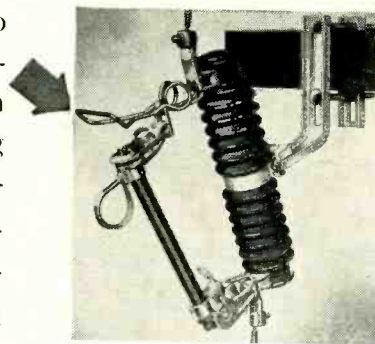

The flat "K" Monel spring on the top casting of this fuse cutout holds the fuse under constant pressure against the upper coating. A coil spring, also "K" Monel, trips the fuse tube when the fuse blows. According to James R. Kearney Corporation "K" Monel springs "are well adapted to applications in heavy industrial areas subjected to a salt and sulphurous atmosphere."

For a more complete discussion of the valuable spring properties of various Inco Nickel Alloys, write for 66 *Practical Ideas for Metal Problems in Electrical Products*. Address, please,



THE INTERNATIONAL NICKEL COMPANY, INC., 67 Wall Street, New York 5, N. Y.

MONEL • "K" MONEL • "S" MONEL • "R" MONEL • "KR" MONEL • INCONEL • NICKEL • "L" NICKEL • "Z" NICKEL

*Reg. U.S. Pat. Off.

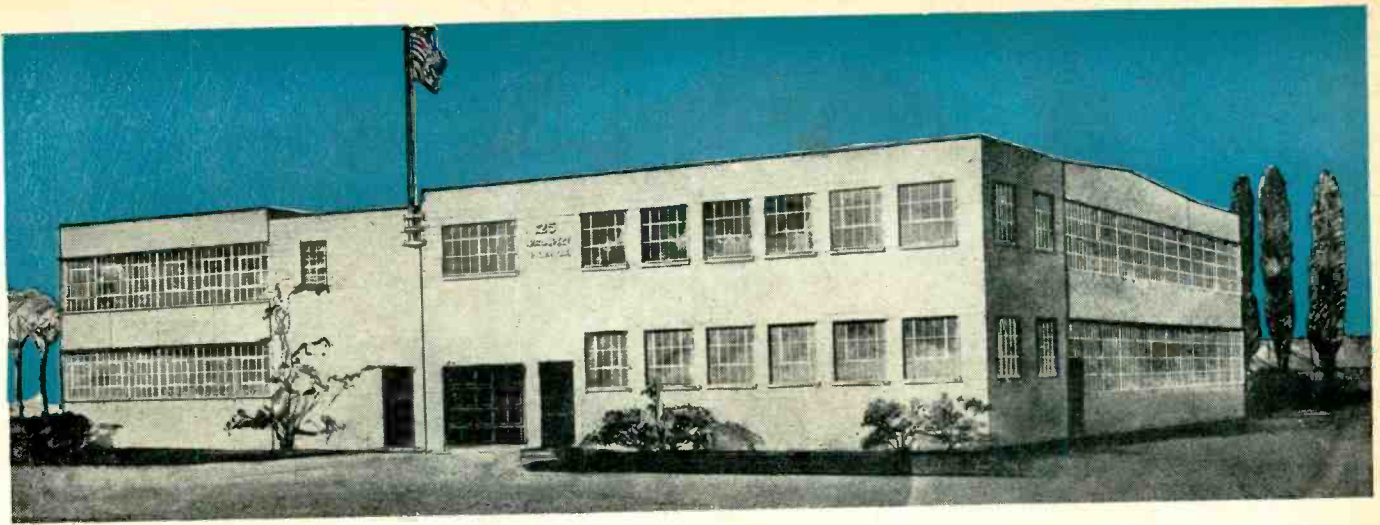

PRESS WIRELESS MANUFACTURING COMPANY, INC.

(Combining Press Wireless Manufacturing Corporation and Milliken Machine Company)

*Designer and Manufacturer of
Communications, Microwave and Electro-Mechanical Equipment*

ANNOUNCES

A NEW 5 KILOWATT TRANSMITTER

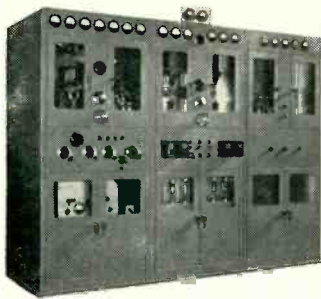

- This versatile, precision unit, housed in one compact cabinet, is a medium-power, frequency shift radiotelegraph-radiotelephone Transmitter combin-

- To augment its already extensive line of Transmitters (ranging from 100 watts to 50 kilowatts) Press Wireless announces a new 5 kilowatt Transmitter, Model T5CM-1, illustrated here.

ing ruggedness and adaptability.

- Press Wireless was first to develop complete "Packaged" Radio Communications Systems—transmitting, receiving and terminal equipment, including everything from the powerline switch to the antenna tower. The PW "Package" purchaser gets not only the most advanced communications equipment available, but he also benefits materially from having everything supplied by the one expert organization.

- Inquiries are invited on communications systems and equipment of any power to meet any requirements.



PRESS WIRELESS MANUFACTURING COMPANY, INC.

First in "Packaged" Communications Equipment—from Antenna Tower to Operating Console
Manufacturing Plants Located at Hicksville, L. I., and West Newton, Mass.



**CAST ALNICO V and VI THIN WALL RINGS
FOR MAGNETIC FOCUSING ASSEMBLIES**

Quality and Quantity - NO PROBLEM!

In TELEVISION SETS, magnetic focusing eliminates blur; gives clear, sharp reception even during warm-up, or line voltage fluctuations; and the *first* focusing adjustment is the *last*. The thin ring-type permanent magnets of Alnico V and VI produced by Arnold for this use (several sizes are pictured here) are *cast*, not sintered, in order to save on first cost. It's a difficult job, but Arnold's advanced methods produce these rings in the desired quality and any quantity, *without trouble*. —No matter what the application, in any grade of Alnico or other materials, you can depend on Arnold Permanent Magnets. We'll welcome your inquiries.

THE ARNOLD ENGINEERING COMPANY

Subsidiary of

ALLEGHENY LUDLUM STEEL CORPORATION

147 East Ontario Street, Chicago 11, Illinois

Specialists and Leaders in the Design, Engineering and Manufacture of PERMANENT MAGNETS



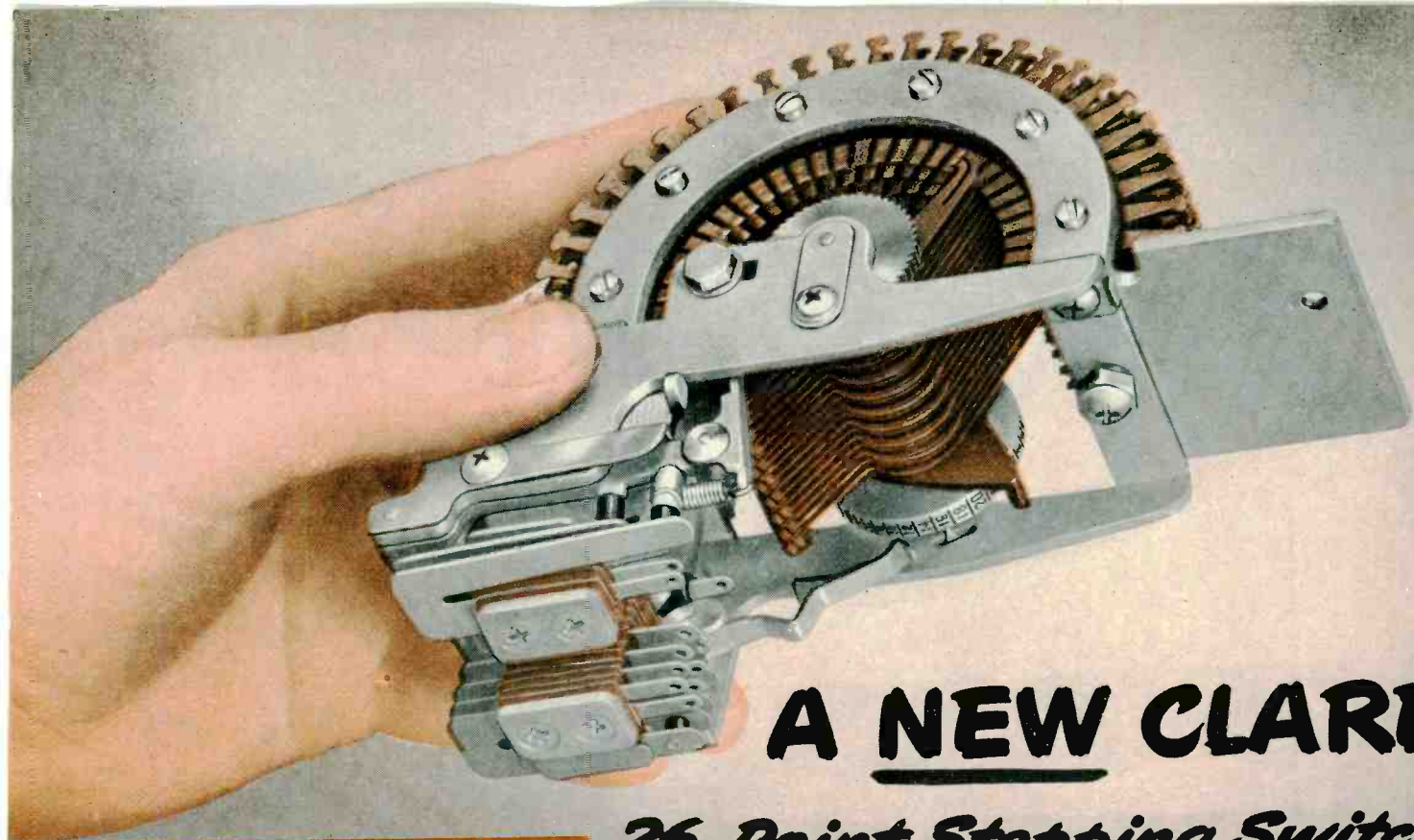

A NEW CLARE

26-Point Stepping Switch

STANDARD SPECIFICATIONS

OPERATION:

Automatic (self-interrupting) or remote controlled.

WIPERS:

One to ten, traversing individual contact levels.

INTERRUPTER SPRINGS:

Form 1B (to open the operating circuit at the end of each step). Contacts are single platinum-iridium.

OPERATE SPEED:

Remote controlled operation: maximum 30 steps per second. Self cycling operation: average 60 steps per second, with 48-volt power supply.

FINISH:

Framework and armature: cadmium; Bank contacts and wipers: phosphor bronze.

MOUNTING:

Frame drilled and tapped at each end to accommodate No. 8-32 mounting screw.

DIMENSIONS:

Overall length: 6-9/16 in.; width: 2-3/8 in.; height: 4-5/8 in.

NET WEIGHT:

27 oz., approximately.

SHIPPING WEIGHT:

4 lbs., approximately.

Write for Clare Bulletin 101
on complete details.

For Selection - Sequence Control - Counting - Totalizing

Selection of any channel or circuit path from a total of 26 or 52 circuits is provided by this new CLARE Stepping Switch.

This selection may be at the rate of 30 steps per second on remote control—up to 60 steps per second on self-cycling operations. Operating at these speeds, the switch gives a minimum life of 5 million half-revolutions or 130 million stepping operations.

Each of the ten levels possible for the Type 26 Switch, or the five levels of the Type 52 Switch, is unit-molded in Bakelite. Hand positioning of individual contacts is thus eliminated, and each bank level is easily replaced if a contact becomes damaged in service.

In operation, a pair of double-ended wiper springs is stepped over each bank level of 180 degrees. One end of the wipers is engaged with the bank contact at all times, one end is always free of the bank. The stepping magnet may be remotely controlled or wipers may be stepped automatically by interrupting the magnet circuit through a pair of interrupter springs. As many as eight auxiliary interrupter springs may be provided for other control or signal functions.

Like many other CLARE developments, this new stepping switch was designed to meet a specific requirement . . . has provided an answer to others. Whatever your relay problem, it will pay you to submit it to CLARE. Sales engineers are located in principal cities for your convenience. Look in your classified telephone directory . . . or write to C. P. Clare & Co., 4719 West Sunnyside Ave., Chicago 30, Illinois. In Canada: Canadian Line Materials Ltd., Toronto 13. Cable address: CLARELAY.

CLARE RELAYS

First in the Industrial Field

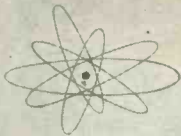

Designers

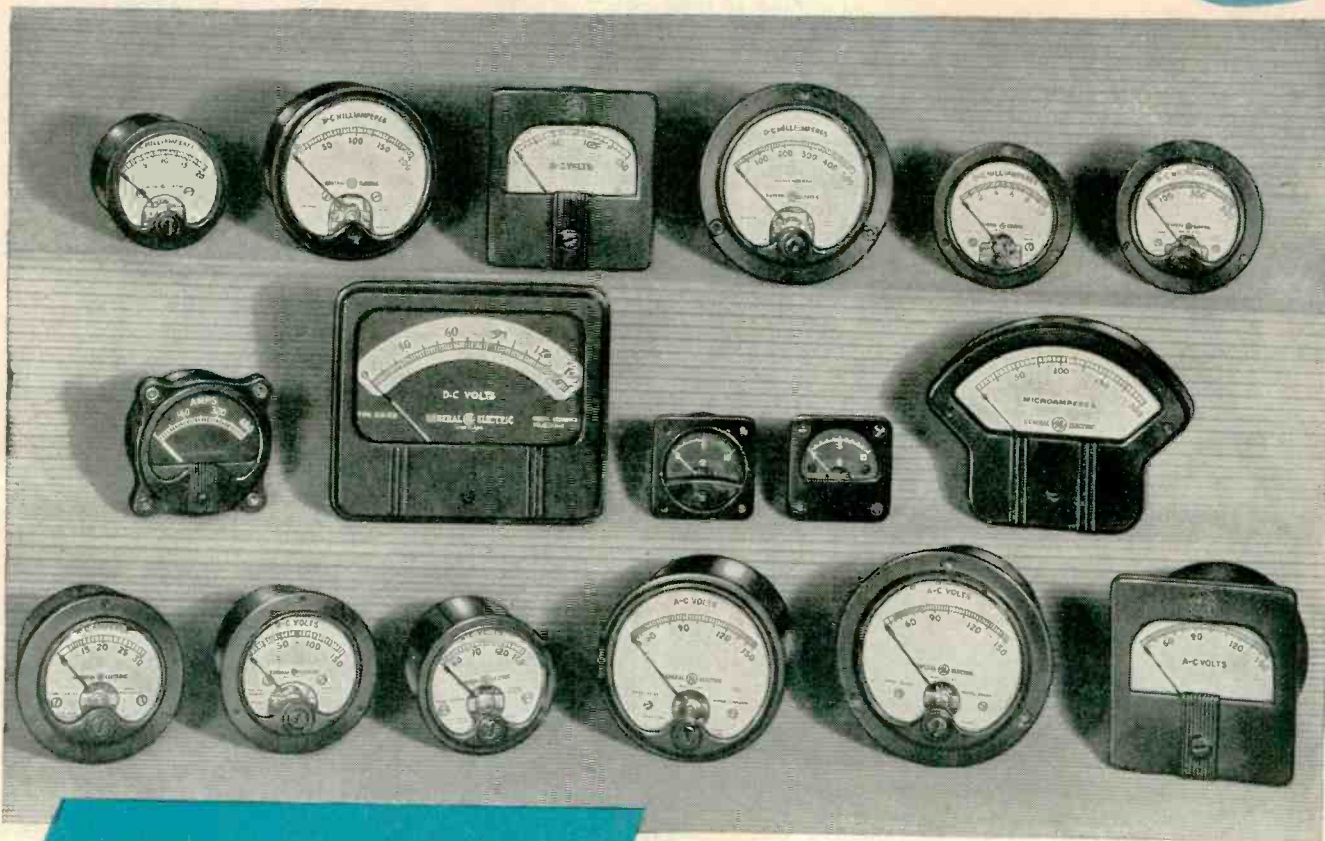

*A panel instrument
for every need*

These general-purpose panel instruments are particularly suitable for use in radio equipment and industrial applications where accuracy and quality are required and space is at a premium. Many of the instruments have been newly styled

for better readability and for the smooth, modern appearance that will help give your panels a well-engineered look.

Thermocouple-type instruments, for measurements of high-frequency alternating current in radio or other electronic circuits, are available. There is also a complete line of rectifier types (a-f), for measuring alternating current or voltage at high frequencies or where the source is not sufficient to operate conventional a-c instruments. Typical applications include television transmitters, radar wave meters, testing equipment for electronic circuits. For a full story of G-E instruments, send for Bulletin GEC-227.

GENERAL  ELECTRIC

Digest

TIMELY HIGHLIGHTS ON G-E COMPONENTS



CAGED FOR PROTECTION

Suitable for wall or panel mounting, these cage-type, enameled resistor units employ a strong, high-heat-resisting silicate-compound body which withstands sudden and extreme temperature changes without weakening or in any

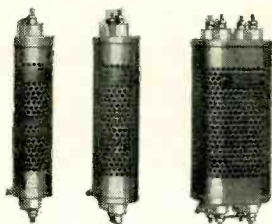

way being injured. The resistance wire has a low temperature coefficient so that the resistance remains nearly constant as the temperature increases. Ample protection to the units is provided by the perforated metal case. Each unit is rated at 85 watts and is available in resistance values from 0.5 to 100,000 ohms; one to four units in a cage. For more complete information please contact your G-E representative.

NEED A "LOW VA" VOLTAGE STABILIZER?

General Electric's latest additions to its line of automatic voltage stabilizers are three 115-volt, 60-cycle designs in 15-, 25-, and 50-va ratings. Check the low prices—you may now be able to utilize the advantages of an automatic voltage control for your application. The price consideration plus the low case height and small size will make these units especially applicable to radio chassis and other shallow-depth installations. Other features include totally insulated design, which is necessary where isolation is required between primary and secondary circuits, and universal lead



construction which makes these units adaptable to various wiring and mounting arrangements. If you have an application problem, contact your G-E representative, or check bulletin GEA-3634B.

SOMETHING NEW IN CIRCUIT CONTROL DEVICES

Simplify your circuit designs by replacing complicated and costly components with simple, economical G-E Thermistors. These electronic semiconductors are unique in that the resistance changes rapidly with slight variations in temperature—electrical resistance decreases as temperature rises, and increases as temperature falls. G-E Ther-

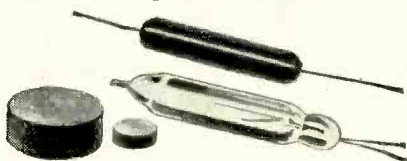

mistors give you these five advantages: flexible in application, small in size, available in various shapes, indefinitely stable, and they are economical. These new circuit devices are especially adaptable as sensitive elements in flow meters, liquid-level gages, time-delay relays, vacuum gages, switching devices, and modulating thermostatic circuits. Check coupon for technical report CDM-9.

HERMETIC SEAL ELIMINATES MOISTURE PROBLEMS

The new cast-glass bushings with their sealed-in metal hardware can be readily welded, soldered, or brazed directly to the apparatus, thus eliminating gaskets and providing a better seal than ever before. The small, compact structure of the bushings often makes it possible to



reduce the overall size and weight of the electric apparatus. Bushings are practically unaffected by weathering, microorganisms, and thermal shock. Their great mechanical strength makes them well suited for use in airplanes, etc., where they are subject to continual vibration. Available in ratings up to 8.6 kv and for currents to 1200 amperes. Check bulletin GEA-5093.

MORE SOLDERING WITH LESS POWER

G.E.'s midget soldering iron can do a big job for you with only one-fourth the wattage usually used. This handy 6-volt, 25-watt iron is only 8 inches long (with $\frac{1}{8}$ " or $\frac{1}{4}$ " tips) and weighs but $1\frac{3}{4}$ ounces. It was especially designed for close-quarter, pin-point precision soldering. The "midget" offers you all these advantages: low-cost soldering; "finger-tip" operation; quick, continuous heat; easy renewal; long life; low maintenance. The iron is a real aid in manufacturing radios, instruments, meters, electric appliances, and many other products requiring precision soldering. Irons and specially designed 115/6-volt transformers are available from stock. Check bulletin GES-3488.



GENERAL ELECTRIC COMPANY, Section H 642-18
Apparatus Department, Schenectady, N. Y.

Please send me the following bulletins:

- | | |
|---|---|
| <input type="checkbox"/> GEC-227 Instruments | <input type="checkbox"/> GEA-5093 Cast-Glass Bushings |
| <input type="checkbox"/> GES-3488 Midget Soldering Iron | <input type="checkbox"/> CDM-9 Thermistors |
| <input type="checkbox"/> GEA-3634B Voltage Stabilizer | |

Name

Company

Address

City State

TURN TO PLAX FOR PLASTICS

Plax supplies materials below in forms as checked. They are available in a full color range.

	SHEET	ROD	TUBE	FIBER	BLOWN WARE	MACHINED PARTS
Cellulose Acetate	✓	✓	✓	✓	✓	✓
Cellulose Acetate Butyrate	✓	✓	✓	✓	✓	✓
Ethyl Cellulose	✓	✓	✓	✓	✓	
Methacrylate		✓	✓	✓		✓
Polyethylene	✓	✓	✓	✓	✓	✓
Polystyrene	✓	✓	✓	✓	✓	✓

Vinyls, Cerex, Styraloy, Plexene, and certain special copolymers are also available from Plax, as are special extruded shapes in most materials.

Plax is a leading source of plastics in sheet, rod, tube, and fiber blown forms — also machined parts. This ability of Plax to supply a wide variety of plastics in a wide variety of forms simplifies your task of obtaining the best type of material for your product. Plax offers you many unique plastics developments, such as the tough and flexible Polyflex* Sheet, Laminated Polyflex,

and Polyflex fiber forms of polystyrene. At your disposal, too, is expert advice on plastics applications by Plax engineers and a comprehensive library of technical data (see list of literature). These advantages point convincingly to the wisdom of turning to Plax for your plastics requirements — for both materials and the guidance you may need in their application.

PACIFIC COAST REPRESENTATIVE, GLENN H. TAYLOR CO., LOS ANGELES

*T.M. Reg. U.S. Pat. Off.

WRITE FOR THIS POLYSTYRENE DATA

- How to Machine Plax Polystyrene Products.
- How to Use Coolants with Plax Polystyrene Products.
- How to Cement Plax Polystyrene Products.
- How to Polish Plax Polystyrene Products.
- Notes on Design and Assembly of Plax Polystyrene Products.
- Die-cut Parts from Plax Polystyrene.
- How to Form Plax Polystyrene Rod.

AND THIS PRODUCT INFORMATION

- Data Sheets on Plax Cellulose Acetate, Cellulose Acetate Butyrate, Methacrylate, Polyethylene, Polystyrene and Ethyl Cellulose Products.
- Article on Plax's Blown Products.
- New special plastic shapes by Plax.



P. O. BOX 1019 ★ HARTFORD 1, CONNECTICUT
In Canada — Canadian Industries, Ltd., Montreal

The new Collins 737A
5 kw FM transmitter

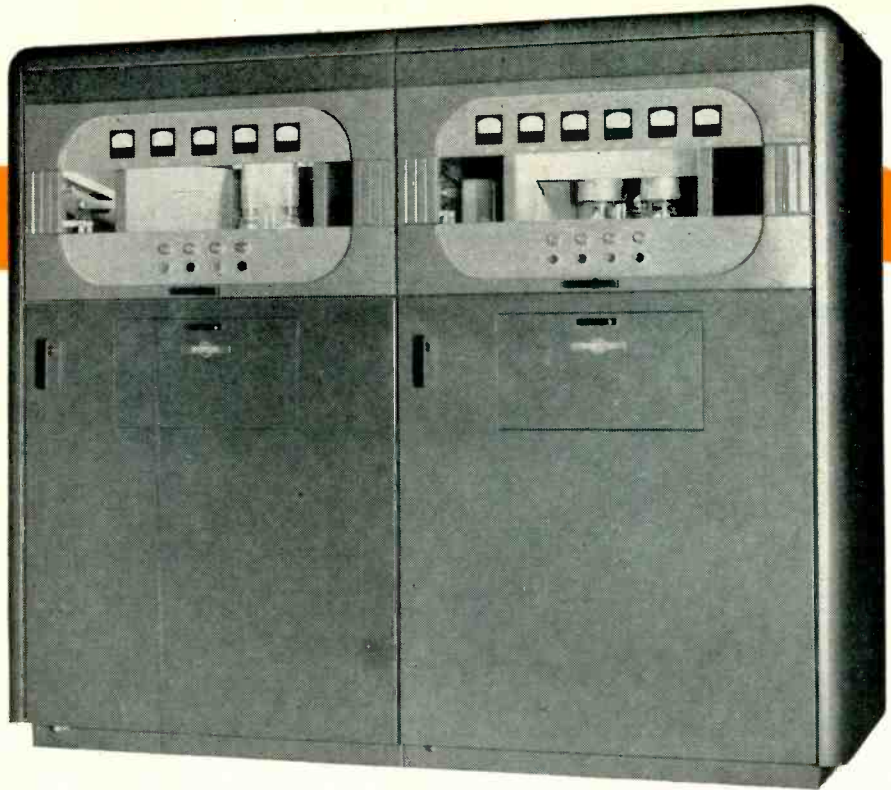

*The most
economical
way...*

to radiate 20 to 40 kilowatts

Those who hold FM grants for 20 to 40 kw radiated power have found themselves confronted with something of a problem.

Neither a 3 kw transmitter and very high gain antenna, nor a 10 kw transmitter and low gain antenna, is the ideal combination. The first is risky because of transmission line loss, and the second calls for an unduly expensive transmitter.

A better and far more economical balance is found in the combination of the new Collins 737A 5 kw FM transmitter and a Collins four to eight bay 37M FM ring antenna. This transmitter delivers plenty of power to overcome transmission losses to the antenna, and the savings in costs in obtaining 20 to 40 kilowatts of radiated power are very substantial.

The 737A costs much less than a 10 kw transmitter to buy, ship and install. It requires less than 66 square feet of floor space with all doors

open; its external plate transformer approximately 6 square feet. The power demand is only 11.5 kw, 90% power factor at maximum rated transmitter output. The 737A's complement of 29 tubes includes but 10 tube types, minimizing the number of maintenance spares.

You also save in antenna cost. A large transmission line is not required; standard 1 5/8" line will handle the load. Thus windloading is reduced and, especially with the Collins 37M series top or side mounting FM ring antennas, lighter structures may be used.

Economy is an increasingly important factor in the successful conduct of a broadcasting business. Whatever power you intend to put on the air, call us in for consultation. The Collins line of FM transmitters ranges from 250 to 50,000 watts, *and includes the only 5 kw FM transmitter on the market!*

FOR THE BEST IN FM, IT'S . . .



COLLINS RADIO COMPANY, Cedar Rapids, Iowa

11 W. 42nd St., New York 18, N. Y.

458 S. Spring St., Los Angeles 13, Calif.

YOU, TOO, will be interested

in this advertisement — currently appearing in radio amateur journals — because it contains information of interest also to radio engineers.



HYTRON
5514
\$4.95

How Hams are using the HYTRON 5514



Most complete characteristics sheet for a transmitting triode; typical operation data for 8 plate potentials. Also class B Interchangeability Chart demonstrating comparatively the 5514's superiority over other triodes. Write for both.



WIPEK's complete 350-w, 3.5-to-28-mc, phone/c-w transmitter uses 4 Hytron 5514's — class B and C — and only 7 cubic feet of space. QST for Sept., 1947, pp. 37-46.

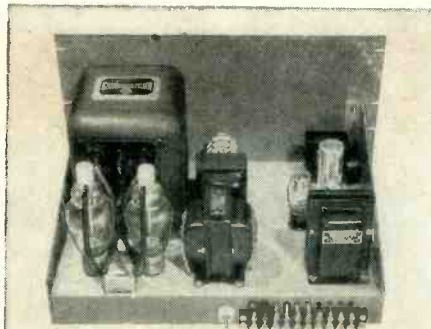

Two 5514's class B deliver 300 w at 1250 plate v, zero bias. (At 1500 plate v, -4.5 v bias, 5514's will give 400 w class B.) RADIO HANDBOOK, 11th Ed., pp. 336-337.



W1IVU's half-kw rig on single chassis. Economical zero bias throughout. All Hytron: 2E25 osc., 5514 driver, 5514 push-pull final. CQ for Oct., 1947, pp. 32-35.



Simple, economical, 3-stage, 3.5-to-28-mc outfit. Single 5514 gives 43 to 200 w output at 400-1500 plate v. THE RADIO AMATEUR'S HANDBOOK, 25th Ed., pp. 184-187.

Tube data sheets are helpful. Those for the Hytron 5514, unusually so. But seeing how the other fellow has put the 5514 to work is even better. The articles describing the illustrated transmitters bristle with "hot" ideas. It will pay you to review them. Write also for both of the 5514 data sheets. Discover for yourself why the Hytron 5514 is so popular: Low internal tube drop and consequent high efficiency at plate potentials from 400 to 1500 volts. Generous output, low drive. Ready interchangeability with other triodes. In short, an economical, all-purpose ham tube designed for hams. Plan to put the 5514 to work in your rig, too. See it — buy it at your Hytron jobber's.

GOT TVI TROUBLES?

Two 5514's in properly balanced Class B R-F — 1500 v at 350 ma plate, -4.5 v bias, 6.5 w grid driving power — deliver 400 w c-w output essentially harmonic-free. See National ad p. 85, July QST.

SPECIALISTS IN RADIO RECEIVING TUBES SINCE 1921

HYTRON

RADIO AND ELECTRONICS CORP.



MAIN OFFICE: SALEM, MASSACHUSETTS

MAKE IT *MOVE* with **alliance** MOTORS

Alliance Motors operate automatic controls, valves, switches, fans and blowers, air circulators, motion displays, phonograph turntables, record changers, air conditioning units, room heaters, automobile heaters, electric fans, magnetic disc tape and wire recorders, radio tuning, automatic television tuning, toys, business machines, hair dryers and numerous other devices.

Horse power ratings range all the way from 1/400th up to 1/30th h.p. Alliance Motors are light-weight, compact, and are mass-produced at low cost—made in both shaded pole induction and split-phase resistor type. Designed for particular jobs, some are uni-directional, others are reversible. Alliance makes motors for both continuous and intermittent duty. Wherever designs call for more motion—automatic action—remember, there is an Alliance Motor for the job!

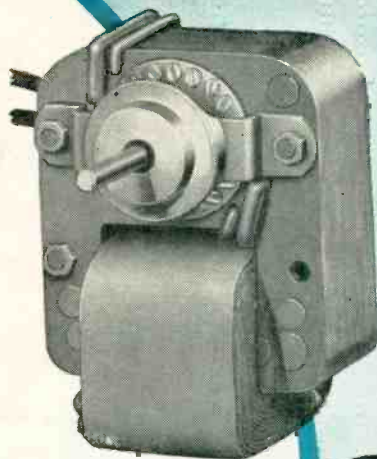

Model K shaded pole induction type will develop up to 1/100th h.p.

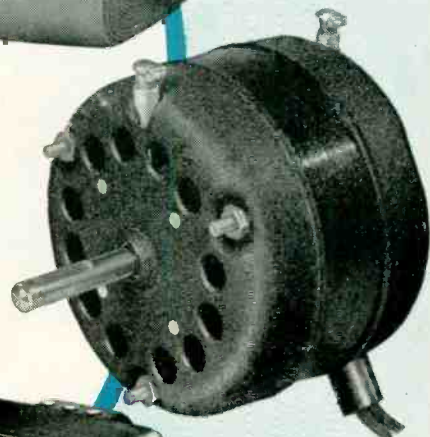

Model A fan motor, 6-pole shaded design. Approximately 1/30th h.p.



Model B—for fans and recorders. Approximately 1/30th h.p. 4-pole shaded pole motor.

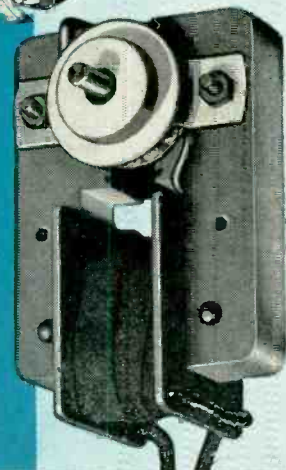

Model MS shaded pole induction type motor, full load h.p. .0021

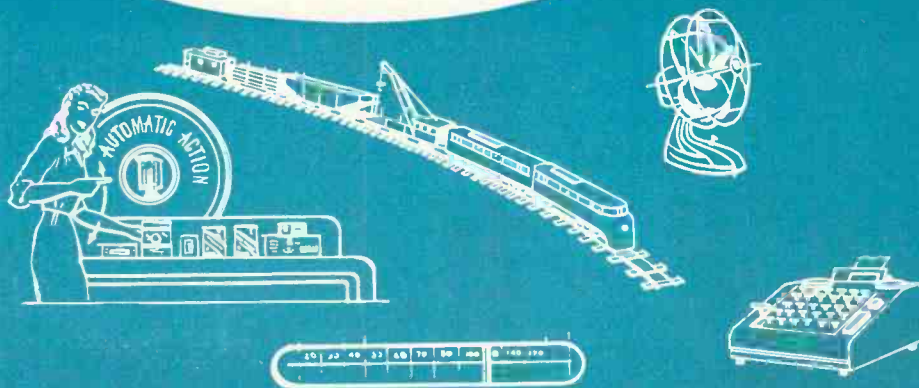

WHEN YOU DESIGN—KEEP

alliance

MOTORS IN MIND

ALLIANCE MANUFACTURING COMPANY • ALLIANCE, OHIO
Export Department: 401 Broadway, New York 13, N. Y., U. S. A.

Watch  Master

Frequency Standards



**GUARANTEED
ACCURACY
1 part in 100,000
(.001%)**

Type 2121 A.

TERMINATION

Front and Rear

CONSTRUCTION

Standard 8 $\frac{3}{4}$ " x 19" Panel

HOUSING

8 $\frac{3}{4}$ " x 19" x 8" Metal Cabinet

WEIGHT

25 pounds

Uses

Time bases, rate indicators, clock systems, chronographs, geo-physical prospecting, control devices and for running small synchronous motors.

Features

1. Bimetallic, temperature-compensated fork, no heating or heat-up time is required.
2. Fork is hermetically sealed, no barometric effects on frequency.
3. Precision type, non-ageing, low coefficient resistors used where advantageous.
4. Non-linear negative feedback for constant amplitude control.
5. No multi-vibrators used.
6. Synchronous clock simplifies checking with time signal.

Specifications

Accuracy—1 part in 100,000 (.001%).

Temperature coefficient—1 part in 1,000,000 per degree centigrade (or better).

Outputs—

1. 60 cycles, sine wave, 0-110 volts at 0 to 10 watts (adjustable).
2. 120 cycle pulses, 30 volts negative.
3. 240 cycle pulses, 30 volts positive and negative. Pulse duration, 100 micro-seconds.

product of

**AMERICAN TIME PRODUCTS
INC.** New York 19, N. Y.

580 Fifth Avenue

Operating under patents of the Western Electric Company

American Time Products, Inc.,
580 Fifth Ave., New York 19, N. Y.

Gentlemen:

Please send descriptive folder, No. 2121A.

Name.....

Company.....

Address.....

City..... State.....

Here's the

flexible
insulation
you need...

FOR HIGH HEAT
APPLICATIONS

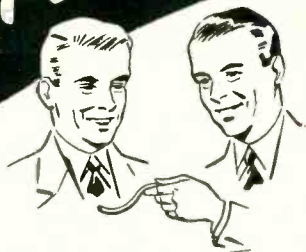

THE NEW
TURBO

REL 16-A

THERMO PLASTIC TUBING

FEATURING:

- ★ PERMANENT FLEXIBILITY
- ★ EXTREME HEAT RESISTANCE
- ★ NON-COMBUSTIBLE
- ★ MOISTURE ABSORPTION LESS THAN 1%
- ★ HIGH DIELECTRIC STRENGTH
- ★ SMOOTH WALL FINISH
- ★ EXPANDED RANGE OF WALL THICKNESSES

REL 16-A is the new heat-resistant TURBO Thermo-plastic Tubing that provides an economical and dependable solution to most electric insulating problems involving high temperature. Approved by the Underwriters' Laboratories for continuous operation at 105° Centigrade, REL 16-A safely withstands even higher temperatures intermittently, without deterioration of mechanical or electrical characteristics. In addition to complete stability under high heat, REL 16-A tubing provides permanent flexibility—maintained under

severe temperature conditions, high dielectric strength, negligible moisture absorption (less than 1%). Typical applications in which this tubing offers important advantages over ordinary tubing include the insulation of coils and wiring where baking, potting or soldering is required; equipment with high thermal rise; enclosed units such as motors, generators, transformers, etc. Write today for complete laboratory test results, including UL reports, on TURBO REL 16-A. Samples on request.

TURBO

WILLIAM BRAND & COMPANY

276 4th Ave., New York 10, N. Y.—325 W. Huron St., Chicago 10, Ill.

Manufacturers of TURBO FLEXIBLE VARNISHED SLEEVING, FIBROUS GLASS TUBING, PLASTIC INSULATED WIRE, MICA AND MICA PRODUCTS, VARNISHED CAMBRICS, INSULATING PAPER and TAPES, WIRE MARKERS

new!

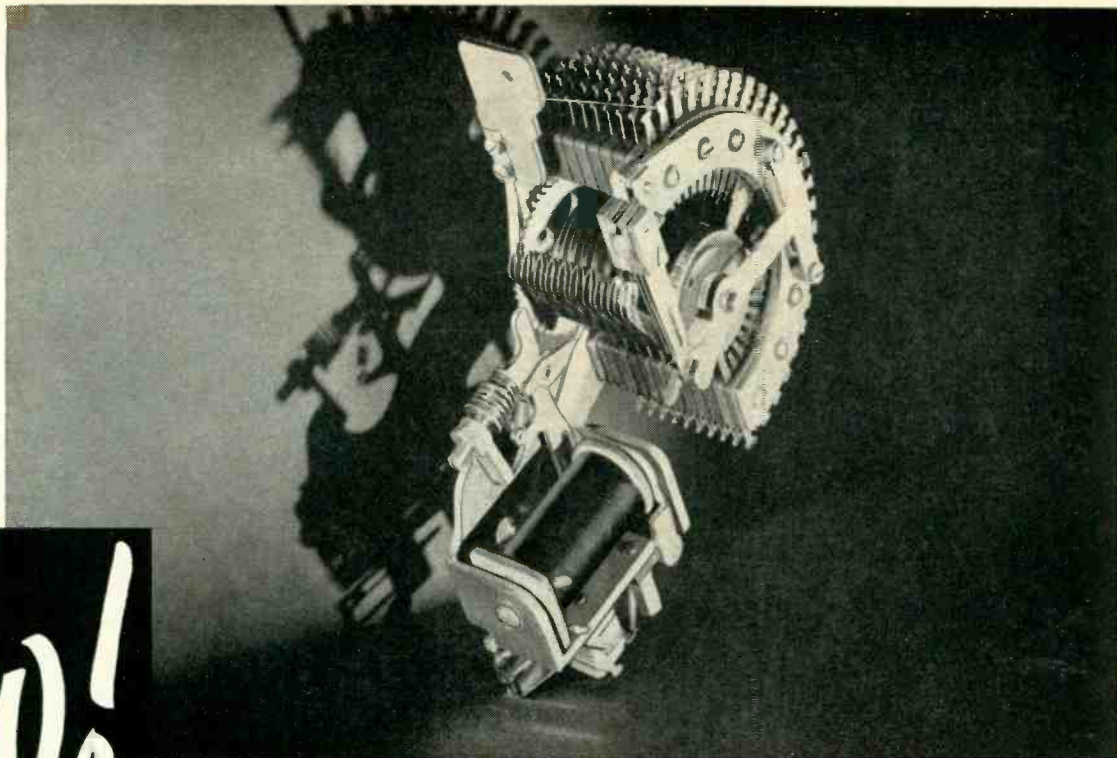

the Type 45 Rotary Switch

**70 Steps a Second Speed
Up to 10 (or more) Bank Levels
Only 1 Field Adjustment**

For *all* the features you want . . . in *any* remote-control application . . . look to Automatic Electric's Type 45 Rotary Switch!

SPEED . . . it's faster! It carries 10 wipers at 70 steps a second on 46 volts d.c. self-interrupted, or at 35 steps a second, externally interrupted.

CAPACITY . . . it's greater! Ten or more 25-point bank levels can be accommodated on the same frame, and single ended wipers can be provided for 50-point operation.

ADJUSTMENT . . . it's simpler! A rare readjustment of the interrupter springs is all that's normally required.

OPERATION . . . it's smoother! With an even load on *all* contacts, the Type 45 runs without galloping; there's no chatter or bounce.

ADAPTABILITY . . . it's more useful! With more levels, faster speed and 25- or 50-point operation, it's suitable for a wider variety of control applications.

For complete information on this switch that's new and better, write for our new circular.

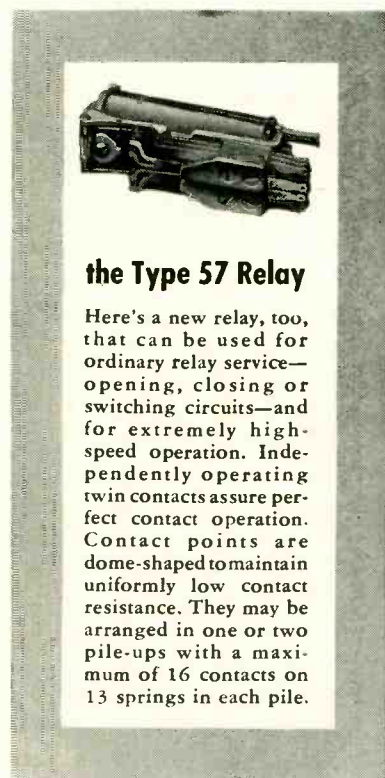

the Type 57 Relay

Here's a new relay, too, that can be used for ordinary relay service—opening, closing or switching circuits—and for extremely high-speed operation. Independently operating twin contacts assure perfect contact operation. Contact points are dome-shaped to maintain uniformly low contact resistance. They may be arranged in one or two pile-ups with a maximum of 16 contacts on 13 springs in each pile.

AUTOMATIC  ELECTRIC

Distributors in U. S. and Possessions:

Automatic Electric Sales Corporation

1033 West Van Buren Street, Chicago 7, Illinois

In Canada: Automatic Electric (Canada) Limited, Toronto

**See it
in Action!**

November 1, 2, 3

. . . at the National Electronics Conference

NORTH

SOUTH

EAST

WEST...

**millions listen to broadcasts
from local low-power
AM transmitters using
General Electric economy tubes!**

LOW-PRICED because of large production . . . due to large demand! Shown here are representative G-E power tubes with a nation-wide name for reliability. Specify General Electric tubes in that new transmitter you're designing, to get the biggest dollar-value . . . to get the right tubes (G.E., from its wide list of types, can match precisely your circuit requirements) . . . to enhance your product's standing in the eyes of quality-conscious buyers. A phone-call to your nearby G-E electronics office will bring helpful counsel from tube engineers glad to focus their experience on your problems. Act today!

If you operate a broadcast station, you're interested in fast replacement service. Time off the air is money out-of-pocket. General Electric tubes score again . . . there's a G-E distributor or dealer right in your area, with ample stocks on hand, waiting for your request to rush new tubes to you. You get the types you want, when you want them—built right, priced right, sold right with the solid backing of General Electric's tube warranty! *Electronics Department, General Electric Company, Schenectady 5, New York.*

GENERAL  ELECTRIC

FIRST AND GREATEST NAME IN ELECTRONICS

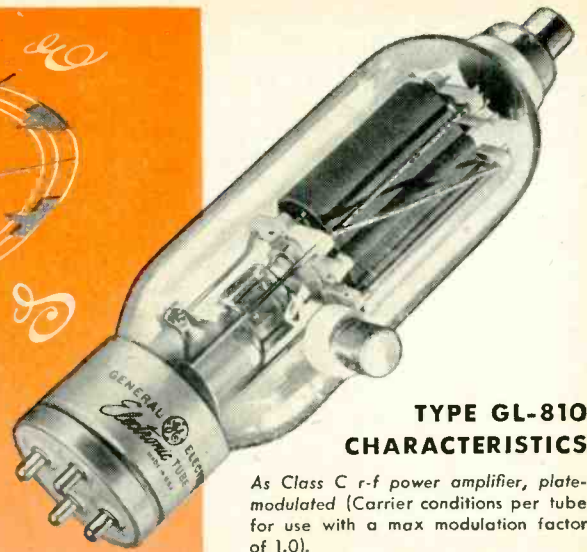

**TYPE GL-810
CHARACTERISTICS**

As Class C r-f power amplifier, plate-modulated (Carrier conditions per tube for use with a max modulation factor of 1.0).

Filament voltage	10 v
current	4.5 amp
Max ratings (CCS):	
d-c plate voltage	1,600 v
d-c grid voltage	-500 v
d-c plate current	210 ma
d-c grid current (approx)	70 ma
plate input	335 w
plate dissipation	85 w
Typical operation:	
d-c plate voltage	1,600 v
d-c grid voltage	-200 v
d-c plate current	210 ma
d-c grid current (approx)	50 ma
driving power (approx)	17 w
plate power output	250 w



**GL-810
TRIODE**

**GL-828
BEAM
POWER
TUBE**



**TYPE GL-828
CHARACTERISTICS**

As Class AB₁ a-f power amplifier and modulator

Filament voltage	10 v
current	3.25 amp
Max ratings (CCS):	
d-c plate voltage	1,750 v
d-c suppressor voltage	100 v
d-c screen voltage	750 v
*max signal d-c plate current	150 ma
*max signal d-c plate input	225 w
*screen input	16 w
*plate dissipation	70 w
Typical operation (CCS), 2 tubes:	
d-c plate voltage	1,700 v
d-c suppressor voltage	60 v
d-c screen voltage	750 v
d-c grid voltage	-120 v
peak a-f grid-to-grid voltage	240 v
zero signal d-c plate current	50 ma
max signal d-c plate current	248 ma
d-c suppressor current	9 ma
zero signal d-c screen current	4 ma
max signal d-c screen current	43 ma
effective load, plate-to-plate	16,200 ohms
*max signal plate power output	300 w



* Averaged over any a-f cycle of sine-wave form.

** Distortion only 1 per cent with 20 db of feedback to grid of driver.

ERIE TRIMMERS

for easy assembly and dependable performance at reasonable cost

HERE are six popular ERIE Resistor trimmers, all notable for their fidelity to specifications, their rugged stability, and their straight-line capacity change throughout the total range.

The new miniature style Tubular Trimmers and Styles 554 and 557 open up many design possibilities for added efficiency in chassis layout.

General specifications are given below. Samples will be sent to interested manufacturers on request.

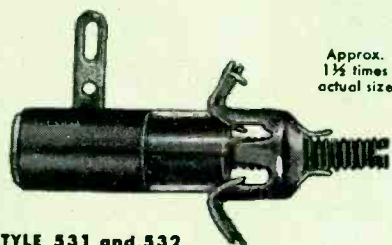

STYLE 531 and 532

Approx.
1 1/4 times
actual size

STYLES 531 and 532

Capacity Ranges: 0.5-5 MMF & 1-8 MMF
Working Voltage: 500 V.D.C.
Max. Temperature: 75°C
Q Factor @ 1 MC.: 1,000 min.
Initial Leakage Resistance: 10,000 megohms min.
Styles: 531 for panels .015" to .039"; 532 for .040" to .065"

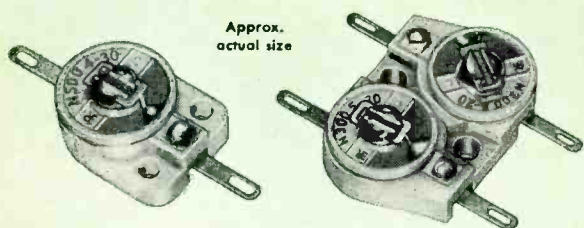

STYLE TS2A

STYLE TD2A

Approx.
actual size

STYLES TS2A and TD2A

Capacity Ranges:
Zero Temp. Coeff. 1.5-7 MMF & 3-12 MMF
N300 Temp. Coeff. 3-13 MMF & 5-20 MMF
N500 Temp. Coeff. 4-30 MMF & 7-45 MMF
Working Voltage: 500 V.D.C.
Q Factor @ 1 MC.: 500 min.
Initial Leakage Resistance: 10,000 megohms min.
Styles: TS2A, Single Condenser;
TD2A, Dual Condenser

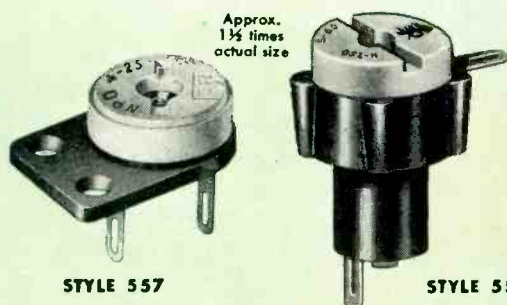

STYLE 557

STYLE 554

Approx.
1 1/4 times
actual size

STYLES 554 and 557

Capacity Ranges:
Zero Temp. Coeff. 3-12 MMF & 5-25 MMF
N750 Temp. Coeff. 5-30 MMF & 8-50 MMF
Working Voltage: 350 V.D.C.
Q Factor @ 1 MC.: 500 min.
Initial Leakage Resistance: 10,000 megohms min.
Styles: 554 Mounted with Spring-Clip; 557 for Sub-panel or Bracket Mounting

Electronics Division
ERIE RESISTOR CORP., ERIE, PA.
LONDON, ENGLAND . . . TORONTO, CANADA



**LIKE FAMOUS
WASHING-MACHINE MAKERS
YOU, TOO CAN
Mangle Costs
Stop Profit-Shrinkage
Starch up Sales**



with AMERICAN PHILLIPS SCREWS

LOSSES WASHED UP! Coin-slot washer-manufacturers can't afford to use slotted screws. For, as one maker says: "Slotted-driver gouges would cost us 50c to \$5.00 to refinish a painted panel." American Phillips Screws stop all that. And they start new savings — of several seconds per screw — that add up as high as 50%.

SALES STARCHED UP! Unburred American Phillips Screwheads mean that coin-laundry customers can't snag the clothes they put into machines. And these stay-tight screws mean, too, that washers are less often down for repair. Find out what double-edged production and sales-spurs American Phillips Screws can apply to your product. Write.

AMERICAN SCREW COMPANY, PROVIDENCE 1, RHODE ISLAND

Chicago 11: 589 E. Illinois St.

Detroit 2: 502 Stephenson Building

**4-WINGED DRIVER CAN'T SLIP OUT
OF PHILLIPS TAPERED RECESS**



**AMERICAN
PHILLIPS** *Screws*

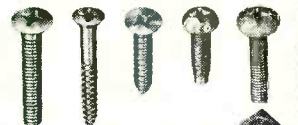

ALL TYPES
ALL METALS: Steel,
Brass, Bronze, Stain-
less Steel, Aluminum,
Monel, Everdur (sil-
icon bronze)

DEPENDABILITY

...can reduce your costs!

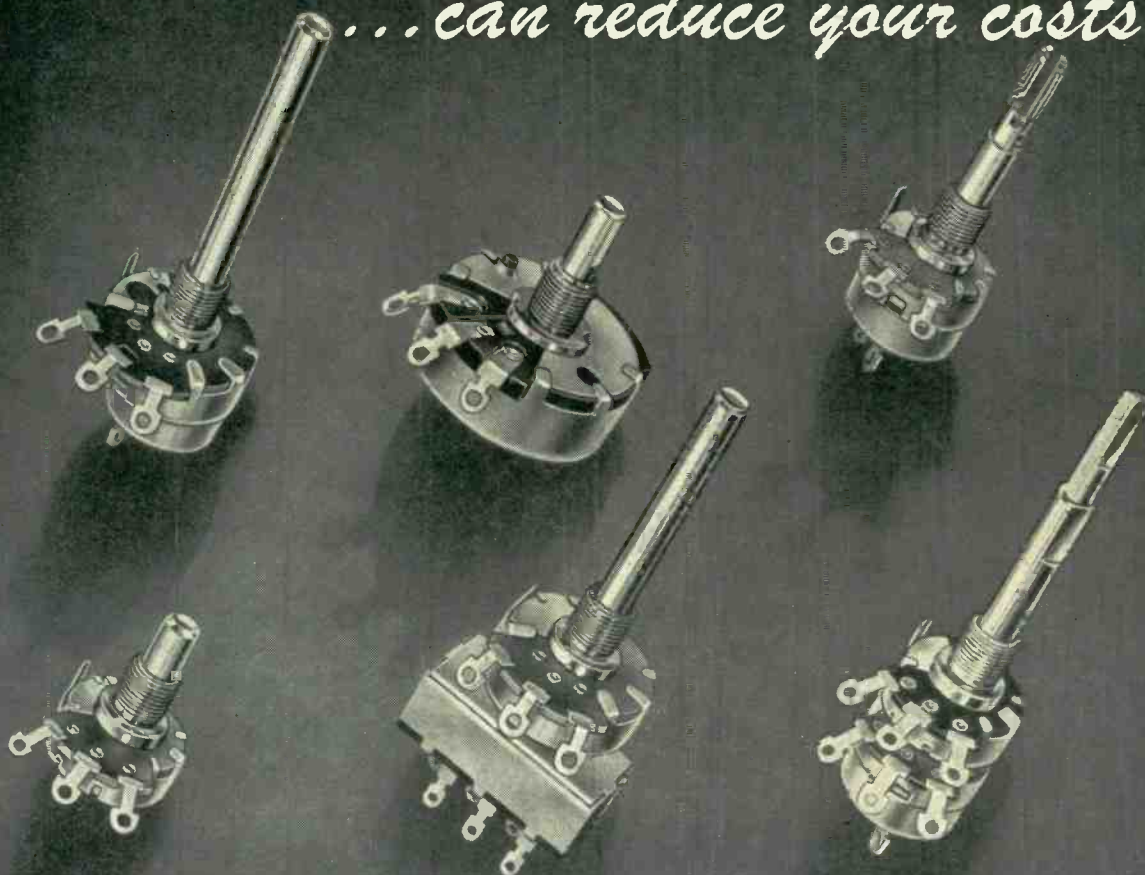

You can *depend* on Stackpole controls. Carefully supervised production means that you can depend on each unit to operate satisfactorily after it has been soldered into the circuit — and Stackpole facilities are such that you can depend, too, on *quantity deliveries* to meet *your* needs.

In both fixed and variable resistors, Stackpole is a major supplier to an im-

portant segment of the radio and electronic industries. If you are not already checking Stackpole regularly as your production releases and design requirements come up, we welcome the opportunity to cooperate on your next assignment. Write for Stackpole Control Engineering Bulletin RC-7D. The Complete Stackpole Electronic Components Catalog is also available on request.

STACKPOLE CARBON COMPANY • ST. MARYS, PA.

STACKPOLE

RESISTORS • CONTROLS • SWITCHES • IRON CORES

GI Leads Again



MODEL DR—Deluxe model 4 pole, shaded pole motor for use in all high-grade instruments in which the ultimate in performance is desired. Novel speed change mechanism is both simple and positive in operation.

MODEL DM—Compact low cost 2 pole, shaded pole motor designed for portables, table models and other instruments in which space is an important factor. Simple speed change mechanism incorporates a special long-lasting molded neoprene belt.

with **TWO** rim drive
DUAL SPEED PHONOMOTORS
for **BOTH** 33 $\frac{1}{3}$ and 78 R. P. M. Records

● The new long-playing microgroove records are here. Their enthusiastic reception proves that your 1949 customers will want, *and demand*, dual speed phonographs—operating at 33 $\frac{1}{3}$ R.P.M. for the new records, and at 78 R.P.M. for their existing record collections.

Only General Industries gives you a choice of TWO great new rim drive dual speed phonomotors to meet this profitable market. Built with the same precision that distinguishes all GI products, these dependable rim drive dual speed motors have been thoroughly tested under all operating conditions.

NOW is the time to get complete information about prices and delivery of GI phonomotors, engineered and designed expressly for this newest development in the record industry. Write *today* to:



The GENERAL INDUSTRIES Co.

DEPT. B • ELYRIA, OHIO



PICTURE OF A COMPLETE YEAR'S

ADVERTISING CAMPAIGN IN . . .

FOR MANUFACTURERS OF ELECTRONIC AND

The 12 monthly issues of electronics and the

Editorially, the 12 monthly issues of **ELECTRONICS** bring to its more than 30,000 subscribers authentic and complete reviews of technical developments and applications vital to all whose interests lie in any phase of the vast aspects of the electronic industry. Because this technical coverage is so complete and timely — because **ELECTRONICS** has been outstanding in its field for better than a decade and a half, design engineers of all types, and management, consider it essential to their work.

Manufacturers have learned, either by observation or through conversation with their own engineers, of the industry-wide acceptance and coverage of **ELECTRONICS**. To them, as well as to engineers, its leadership has been, and is an accepted, proven fact.

It follows, therefore, that there is no better place for a manufacturer to tell his product story — each month — than in the publication read by users of his products. Manufacturers are certain of reaching old customers and prospects or developing new ones. Inquiries from **ELECTRONICS'** advertising develop new applications and new markets in industries other than are presently utilizing a manufacturer's products. Advertising is certain of careful readership — where it will do the most good in terms of eventual sales. The reason, therefore, that more manufacturers names, both big and small, are regularly seen in the advertising pages of **ELECTRONICS**.



electronics — *First in* **RECOGNITION** —

A MCGRAW-HILL PUBLICATION 330 WEST 42nd ST. NEW YORK 18, NEW YORK



electronics

INDUSTRIAL CONTROL EQUIPMENT

Mid-June issue of the **BUYERS' GUIDE**

Budget **NOW**

FOR THE 1949

13

ISSUES OF

electronics

The Buyers' Guide serves several distinctly different functions than those of the monthly issues of **ELECTRONICS**. First: It is accepted and used as the only complete reference book in the industry. Secondly: It includes a "where-to-buy-it" function in the carefully compiled Directory Section. Thirdly: Its catalogue-type of advertising provides design engineers with technical data on ALL of the manufacturers' products. In this respect it serves as a condensed summary of the advertising in the 12 monthly issues and permits a manufacturer to catalogue his entire line in one issue. Lastly: It saves valuable time for the busy engineer in locating data on a particular component he is designing into some equipment.

These are only a few of the many exclusive features of this recognized reference book. They are, however, the basic reasons for the long and important list of Buyers' Guide advertisers and its wide use by both management and engineers.

Plan now to use it in any campaign designed to sell electronic and industrial control equipment manufacturers. Keep in mind that this one issue is used throughout the year — that it is the only complete reference book on product data and product source. As conclusive proof a manufacturer can quickly determine its wide and valuable use by simply questioning his own engineering staff.

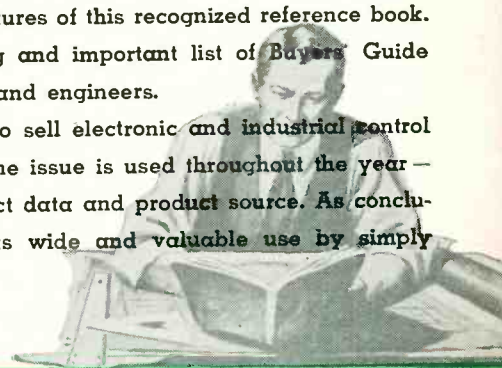

First in **IMPORTANCE** — *First in* **PREFERENCE**





electronics edition - November 1948

DRY ELECTROLYTICS FOR TELEVISION RECEIVERS

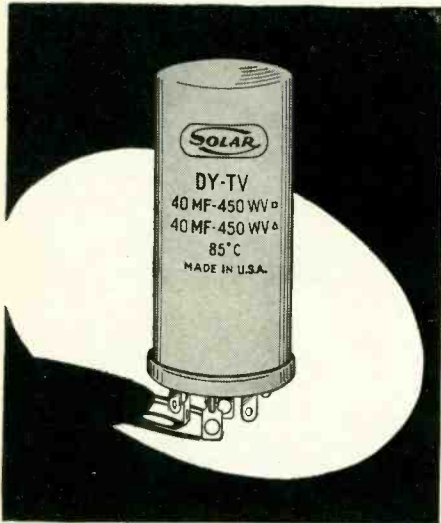

Solar's new Type DY-TV series of dry electrolytic capacitors assures dependable operation under the severest conditions found in television receivers.

An especially developed Solar processing technique makes possible small yet sturdy capacitors designed for high temperature operation with no sacrifice in long life or electrical characteristics.

Because of the remarkable film stability of Solar's DY-TV series of electrolytics, there is but an extremely small change in power factor and leakage current from room temperature to 85° C.

Type DY-TV capacitors, with their special film formation, do not "run away" when voltage is applied after idling under no-voltage conditions at 85° C. These characteristics are retained even after extended shelf life.

Investigate this remarkable achievement in capacitor design today! Write today for catalog.

Solar Manufacturing Corporation
1445 Hudson Blvd., North Bergen, N. J.



BUSINESS BRIEFS

By W. W. MacDONALD

Mobilization Of Industry to meet any possible international contingency is a major concern in Washington and it is known that the powers-that-be are currently studying at least one plan prepared by people in our field. While it would be inadvisable on many counts to disclose the details of such plans, even if they were known, it may be that random thoughts on the subject, picked up by an editor in his travels, will be helpful. . . .

It seems obvious that the ability of any industry to quickly contribute to a war effort would depend to a great extent upon its health at the time such an emergency arose. Thus the number of manufacturers doing a profitable peacetime business in, for example, television apparatus, might be a major factor.

Experience in the last war indicates that while it is in the main desirable to utilize companies having complete engineering as well as production know-how and facilities to head up major projects the number of companies employed as prime contractors should be materially increased.

Despite the obvious wastefulness and risk of design obsolescence involved when government agencies place pilot orders in advance of an actual emergency it seems apparent that no amount of paper planning is such good insurance in a field involving complicated development and manufacturing machinery as cash from the public till.

In particular, it should be remembered that highly specialized component parts not ordinarily employed in commercial gear constituted a major bottleneck in the production of all kinds of electronic apparatus in the last war and that in this branch of the industry at least advance stockpiling or something comparable to it will inevitably be necessary.

More later on this extremely com-

plex problem as the situation develops.

Exhibitors at the Third National Instrument Conference down in Philadelphia (excluding Associations, publishers and other non-manufacturing groups) totalled 150 firms. Ferreting around the booths, we determined that 66 of them employ tubes or other components inherently electronic in nature in the construction of their products and we'll bet that many of the others have something of like nature on the drawing boards back home.

This is a high percentage when compared with what we remember about the first and second shows, and very gratifying when it is considered that the attendance consisted largely of members of the Instrument Society of America, the Industrial Instruments & Regulators Division of the American Society of Mechanical Engineers, the American Institute of Physics, the Joint Subcommittee on Electronic Instruments of the American Institute of Electrical Engineers and the Scientific Apparatus Makers Association.

A Washington Engineer has devised a neat chassis for use by men who spend a lot of time experimenting with breadboard layouts. It comprises a piece of metal bent into a shape that accommodates tube sockets and other parts required in the average small piece of electronic gear, has half-a-dozen parallel busbars supported on insulated terminal strips built in and is used with clever little connectors and clips that permit the bars to be used for most wiring.

We understand the gizmo will shortly be available in commercial form.

Mixed Blessing to component-part manufacturers is the growing popularity of television, largely at

**PRESENT THINKING
ON RESISTORS IS**

OBSOLETE!



**discard your current standards of
performance for fixed composition resistors**



**ANNOUNCES A NEW
ADVANCED RESISTOR**

Read
the
following
pages
carefully,
they will
affect your
planning
for years
to come.

NEW IRC BT RESISTORS obsolete all present standards

IRC
SURPASSES
JAN-R-11

Review your resistor requirements in the light of this advanced resistor.

New, advanced



**TYPE
BT**

BTR unexcelled at 1/3 watt
BTS unexcelled at 1/2 watt
BTA unexcelled at 1 watt
BT-2 unexcelled at 2 watts

IRC
EXCELS
JAN-R-11

IRC's leadership proven by these Test Results for 1/2 watt Type BTS — equally outstanding performance of 1/3, 1 and 2 watt types is shown in Catalog Bulletin B-1.

BT means **Better Technically**

compare this **ADVANCED** resistor to **JAN-R-11** SPECS



Temperature extremes used to play havoc—no longer true.

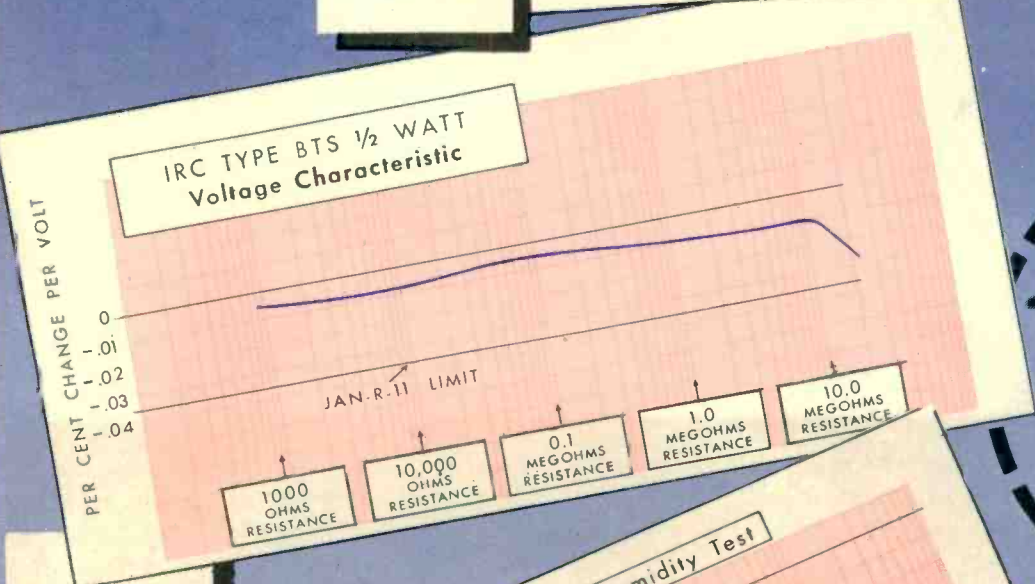
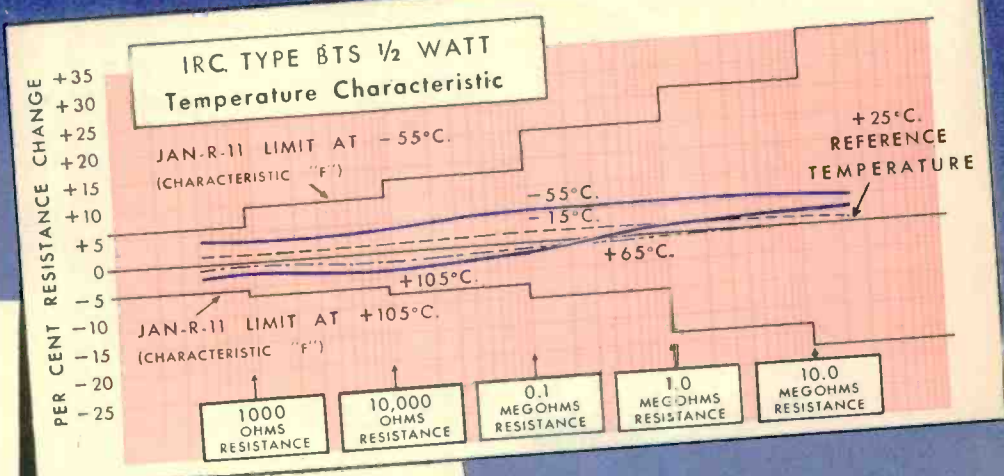

Critical circuits need stability under all conditions.

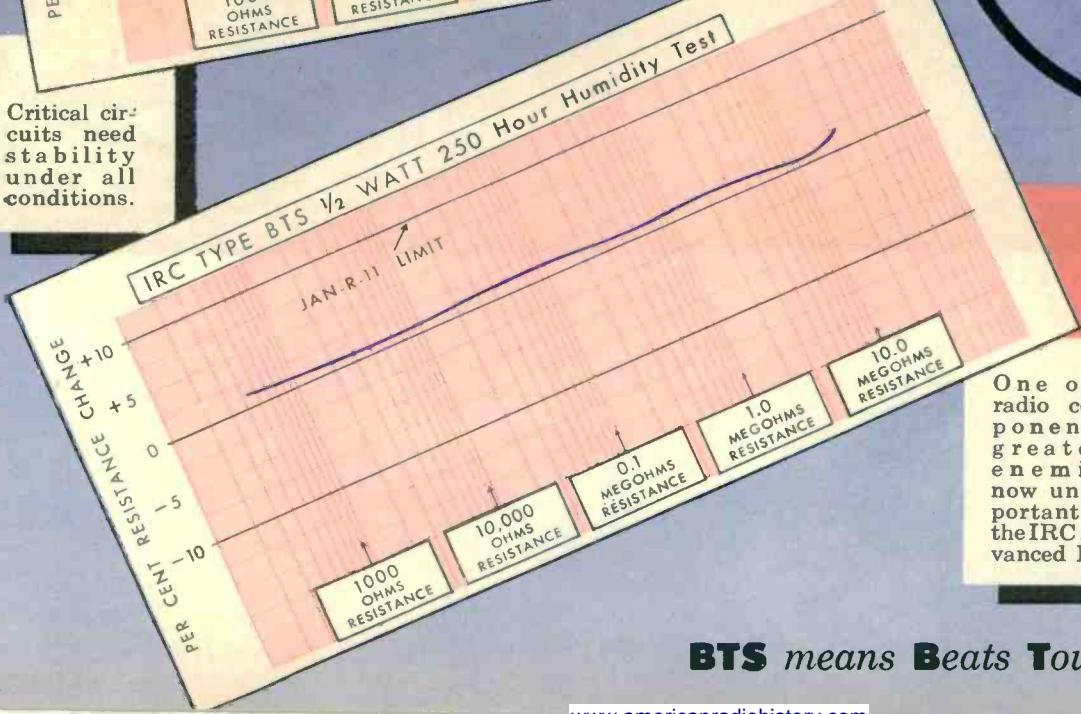

NEXT PAGE SHOWS EQUALLY AMAZING RESULTS IN OTHER CHARACTERISTICS

One of a radio component's greatest enemies now unimportant to the IRC Advanced BT.

BTS means **Beats Toughest Specs**

IRC'S ADVANCED BT AGAIN
 DEMONSTRATES SUPERIOR
 IRC ENGINEERING AND
 PRODUCTION TECHNIQUES

The Armed
 Forces need
 these re-
 sults.

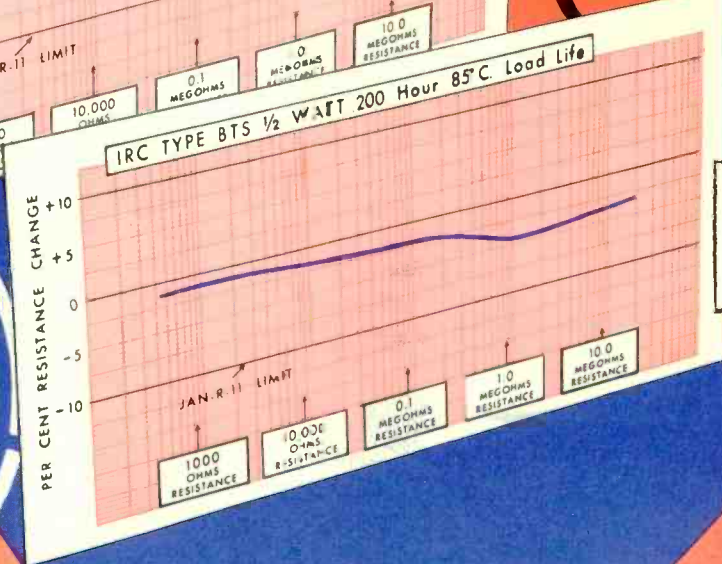
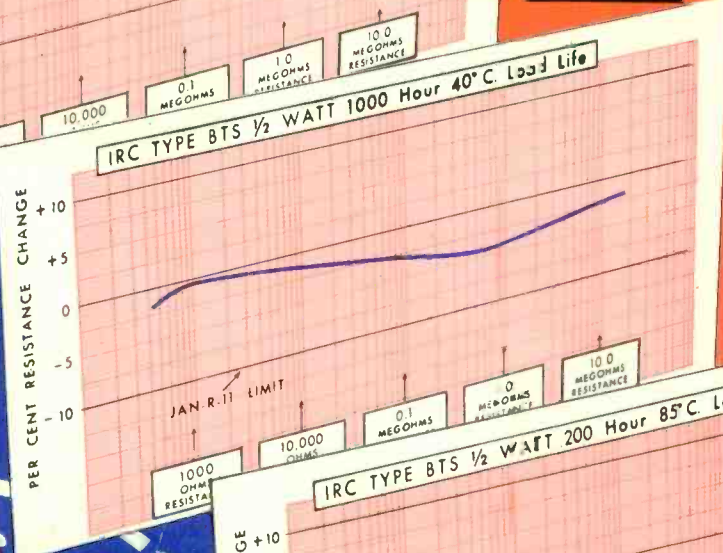
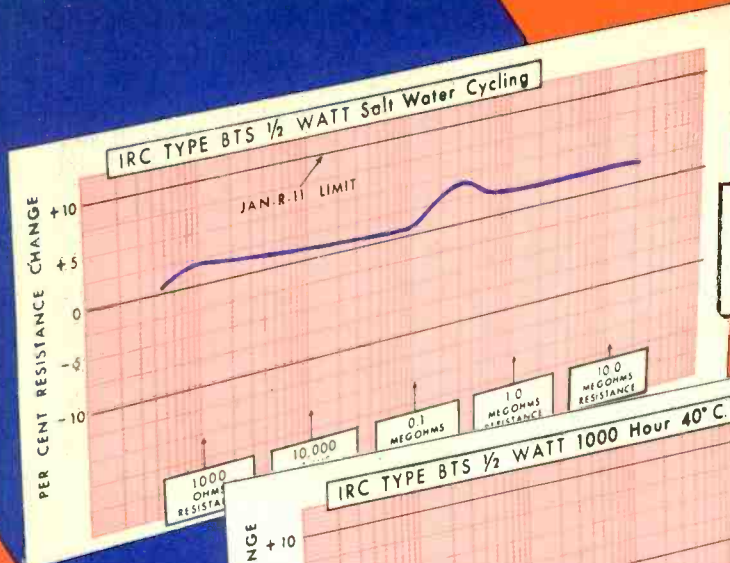

High ambi-
 ents and de-
 pendability
 need these
 results.



BT means
Better Television

There is no blue sky surrounding this advanced resistor. Performance of this new Type BT has been proved by independent testing agencies. It is in production now . . . hundreds of thousands are coming off production lines daily. Its outstanding characteristics are particularly evident in high ambient temperatures, and it easily performs the rigorous requirements of television.

resistor are so advanced, you need complete information on its characteristics. Although Test Results shown here are only for 1/2 watt Type BTS, comparable data is available for BTR, BTA and BT-2 . . . Technical Data Bulletin B-1 gives you the full story. We shall be glad to rush it to your desk or drawing board . . . or to have our representative review your requirements in the light of this advanced resistor. Use the handy coupon below.

Standards for resistor performance set by this new IRC

International Resistance Co.
 401 N. Broad St., Phila. 8, Pa.

I want to know more about IRC's advanced BT Resistor:

- Send me Technical Data Bulletin B-1
- Have your representative call—no obligation.

Name
 Title
 Company
 Address



- POWER RESISTORS •
- PRECISIONS • INSULATED
- COMPOSITION RESISTORS •
- LOW WATTAGE WIRE
- WOUNDS • RHEOSTATS
- CONTROLS • VOLTMETER
- MULTIPLIERS • VOLTAGE
- DIVIDERS • HF AND HIGH
- VOLTAGE RESISTORS

INTERNATIONAL RESISTANCE CO., 401 N. Broad St., Philadelphia 8, Pa.
 IN CANADA: International Resistance Company, Ltd., Toronto, Licensee

An Important Sale at AUCTION

OF THE VALUABLE

ELECTRONIC COMPONENTS AND MANUFACTURING MATERIALS

SURPLUS TO THE PEACETIME REQUIREMENTS

OF THE SUBMARINE SIGNAL COMPANY

ON THE PREMISES 7-11 SEARS ST., BOSTON, MASS.

On Tuesday, Nov. 30th, 1948 at 10:00 A.M.

THE PROPERTY TO BE SOLD CONSISTS OF LARGE STOCKS OF COMPONENTS BOUGHT TO HIGHEST QUALITY STANDARDS FROM THE COUNTRY'S BEST KNOWN MANUFACTURERS

Some of the more important items are indicated below:

- METERS, Hundreds, all types, by Weston, G.E., Triplett, etc., in substantial lots.
- SOLDER, quantity in excess of 2,000 lbs. Kester Solder in 5 lb. spools.
- SWITCHES, Thousands—Cutler Hammer, Mallory, H & H, Micro, in all styles, Push, Toggle, Gang, etc.
- RELAYS, Thousands—Edison, Ward Leonard, Struthers Dunn, in all types.
- BEARINGS, Ball, Roller, many types & sizes by SKF, New Departure, Falmir and others.
- FUSES, quantity in excess of 200,000, Fuse Links, Fuse Blocks, Fuse Clips.
- PLUGS, Receptacles, Connectors, Socket, quantity in excess of 50,000 by Amphenol, Cannon, Jones, etc.
- SPEAKERS and Headsets by Jensen, Western Electric, etc. POTENTIOMETERS, Thousands—Allen Bradley, Clorostat, Mallory, all types and sizes.
- LOGS, Terminals, Spaghetti, Winding Tapes, Potting Compounds, Waxes and many other manufacturing supplies.
- Space does not permit the listing of more than a few representative types of materials, but sales lots are now being established and detailed descriptive catalogs are in preparation—WHITE OR WIRE FOR YOUR COPY TODAY.
- To any one interested in obtaining bulk quantities of Electronic Materials, this sale offers a very exceptional opportunity.
- EXHIBITION items to be sold may be examined from Nov. 22d to Nov. 29, inc. (Sunday & Holiday excepted) between the hours of 9:30 A.M. and 3:00 P.M.

- TRANSFORMERS, quantity in excess of 10,000, Plate and Filament, Power, Audio, by Raytheon, G.E., UTC, Westinghouse, etc., also Chokes.
- ELECTRIC MOTORS, quantity in excess of 3,000, AC, DC, Mostly fractional HP, some Selsyns, Autosyns, Gear Reduction Types.
- VACUUM TUBES, quantity in excess of 20,000 include—RECEIVING TYPES 2A3, 6L6, 6H6, 6V6, 6AC7, 6AK5, 6SG7, 6SH7, 2X2, 76 etc.
- TRANSMITTING TYPES 814, 838, 801A, 807, 808, 829B, etc.
- CATHODE RAY TYPES 5CP1, 5BP1, 5FP7, etc.
- Voltage Regulators, Rectifiers, Crystals, Thyratrons, Magnetrons.
- LAMPS, Miniature, quantity in excess of 80,000 including Mazda 51, 53, 52, 55, S-6 many others.
- MAGNET WIRE, quantity in excess of 10,000 lbs. in Plain Enamel, Single Cotton, Double Cotton, Single Silk, Double Silk, includes considerable Lit.
- HOOKUP WIRE, #16—#20 Gauge Shielded and Unshielded.
- CABLE, Quantity in excess of 200,000 Ft. Co-ax, R.F., Microphone, Power, etc., single and multi-conductor, many shielded and armored for Marine use.
- CAPACITORS, quantity in excess of 20,000 Fixed-Postage, Tubular, Bathub, Receiving and Transmitting types all well known makes represented.
- CONDENSERS, Variable, National, Cardwell, Millen, Etc., Receiving and Transmitting types.
- RESISTORS, quantity in excess of 100,000 Composition, Wire Wound, Fixed and Variable, all types and makes represented.

SALE IS BY ORDER OF
SUBMARINE SIGNAL COMPANY
160 WASHINGTON ST., NORTH
BOSTON, MASS. OWNER

SAMUEL T. FREEMAN & CO.

Established Nov. 12, 1895

Auctioneers

80 FEDERAL ST.
BOSTON, 10, MASS.

27 William St.
New York, 5, New York

1808-10 Chestnut St.
Philadelphia, 3, Pa.

Electrical Resistance Corp.	19
Electro-Modiv Mfg. Co., Inc.	2
Electro-Motive Works	2
Electro-Products Laboratories	229
Electro-Voice, Inc.	178
Electronic Measurements Co.	176
Electronics, Inc.	180
Erie Resistor Corp.	251
Esser Wire Corporation	68
Esser	15
Essex Wire Corporation	222
Gamewell Co.	223
General Cement Mfg. Co.	251
General Ceramics and Sealtite Corp.	227
General Electric Company	173
General Electric Dept.	13, 48, 49, 153
General Industries Co.	61
General Dept.	57, 159, 202, 228, 236
General Radio Co.	149
Gothard Manufacturing Co.	222
Graphic Metallizing Corp.	196
Gray Research and Development Co., Inc.	204
Handy and Harman	286
Harvey Radio Co., Inc.	216
Hassall, Inc. John	225
Hawway Instrument Co.	234
Haydon Mfg. Co., Inc.	197
Helipot Corporation	189
Hewlett-Packard Co.	8, 9
Hytrom Radio and Electronics Corp.	52
Imperial Trading Cloth	208
Indiana Steel Products Co.	28
Industrial Timer Corp.	239
Instrument Resistors Co.	204
Insulation Manufacturers Corp.	121
International Machine Works	229
International Nickel Co., Inc.	44
International Resistance Co.	61a, 61b, 64a, 64b
Jensen Mfg. Co.	37
Johnson Co., E. H.	243
Jones Div., Howard H., Cinch Mfg. Corp.	231
Kahle Engineering Co.	251
Karp Metal Products Co., Inc.	161
Kenyon Transformer Co., Inc.	38
Kester Solder Co.	150
Knuffel and Esser Co.	3
Knights Co., James	212
Lampkin Laboratories, Inc.	251
Lavoie Laboratories	133
Leitch Co., Inc. G. H.	241
Leukurt Electric Co.	140
Lewis Engineering Co.	237
Linde Air Products Co.	244
Lord Manufacturing Co.	39
Machlett Laboratories, Inc.	137
Marnavox Co.	193
Marnecord, Inc.	174
Mallory and Co., Inc., P. R.	66, 119
McGraw-Hill Book Co., Inc.	175
ME Manufacturing Co., Inc.	287
Mosinee Paper Mills Company	160
Murray Hill Books, Inc.	243
Mycalex Corporation of America	190, 191

INDEX TO ADVERTISERS

Aero Transformer Mfg. Co., Graham Div.	247
Aeron Co., Inc., H. W.	227
Aerovox Corporation	24
Aerovox Inc.	30
Aircraft Radio Corp.	200
Allen-Bradley Co.	151
Allen Co., Inc., L. B.	251
Alliance Manufacturing Co.	53
Allied Central Co., Inc.	11
Allied Radio Corporation	229
Alpha Metals, Inc.	194
Altec Lansing Corp.	200
American Electrical Heater Co.	196
American Gas Accumulator Co.	169
American Rheolic Corporation	152
American Lawn Corp.	162
American Sewer Co.	59
American Television and Radio Co.	188
American Time Products, Inc.	54
Amperite Co.	196
Amaconda Wire & Cable Co.	127
Arnold Engineering Co.	46
Arnold Electronics, Inc.	218
Art Wire and Stamping Co.	241
Artistic Corporation	288
Audio Development Co.	210
Audio-Devco, Inc.	131
Avmo, Ltd.	233
Avnet Electric Co.	56
Baker and Williamson, Inc.	240
Barber Lab., Alfred W.	236
Barry Corp.	214
Beaver Gear Works, Inc.	176
Bell Telephone Laboratories	12
Bendix Aviation Corp., Pacific Div.	168
Bentley, Harris Mfg. Co.	10
Beta Electronics Co.	24
Bird Electronics Corp.	231
Billax Corporation	236
Black Electric Co.	241
Bloomington Instrument Co.	232
Brown Engineering Co., Inc.	251
Browning Laboratories, Inc.	186
Brown-Bradley Mills, Inc.	225
Brand and Co., Wm.	65
Bradley Laboratories, Inc.	220
Brantford Radio Corporation	125
Brook and Royce, Inc., Publishers	235
Brooklyne Electric Co.	154
Buck Engineering Co., Inc.	251
Burnham Instrument Co.	197
Burnell and Co.	197
Calite Tungsten Corp.	203
Cambridge The Radium Corp.	213
Canon Radio Engineering Institute	148
Capitol Engineering Institute	237
Caprom Co.	155
Carter Motor Co.	244
Centralab, Div. Globe-Union, Inc., I., J., K.	21
Chicago Condenser Corp.	245
Chicago Transformer, Div. of Essex Wire Corp.	42
Cinch Manufacturing Corp.	117
Chure & Co., C. F.	47
Clark Crystal Co., Inc.	211
Clarus Mfg. Co., Inc.	211
Cleveland Commander	157
Collins Radio Co.	51
Communications Accessories Co.	234
Condenser Products Co.	181
Continental Molded Products Corp.	217
Continental Electric Co.	215
Continental Screw Co.	144
Cornell-Dubilier Electric Corp.	165
Cross Co., H.	251
Danco Electric Co.	233
Dial Light Co. of America	213
Dow Corning Corporation	213
Driver Co., Wilbur B.	139
Dumont Electric Corp.	217
Dumont Labs., Inc. Allen B.	22, 183
East Engineering Co., Inc.	225, 251
Elmer McCoubert, Inc.	27
Electric Indicator Co.	144
Electrical Insulation Co., Inc.	211
Edison, Inc., Thomas A.	233
Elec-Motors, Inc.	233
Electro-Motive Works	2
Electro-Motive Mfg. Co., Inc.	2
Electro-Modiv Mfg. Co., Inc.	2
Electro-Products Laboratories	229
Electro-Voice, Inc.	178
Electronic Measurements Co.	176
Electronics, Inc.	180
Erie Resistor Corp.	251
Esser Wire Corporation	68
Esser	15
Essex Wire Corporation	222
Fairchild Camera and Instrument Corp.	226
Federal Telephone and Radio Corp.	20
Fred Transformer Co., Inc.	29
Furtek-Miller Laboratories	287
Furst Electronics	222
Gamewell Co.	223
General Cement Mfg. Co.	251
General Ceramics and Sealtite Corp.	227
General Electric Company	173
General Electric Dept.	13, 48, 49, 153
General Industries Co.	61
General Dept.	57, 159, 202, 228, 236
General Radio Co.	149
Gothard Manufacturing Co.	222
Graphic Metallizing Corp.	196
Gray Research and Development Co., Inc.	204
Handy and Harman	286
Harvey Radio Co., Inc.	216
Hassall, Inc. John	225
Hawway Instrument Co.	234
Haydon Mfg. Co., Inc.	197
Helipot Corporation	189
Hewlett-Packard Co.	8, 9
Hytrom Radio and Electronics Corp.	52
Imperial Trading Cloth	208
Indiana Steel Products Co.	28
Industrial Timer Corp.	239
Instrument Resistors Co.	204
Insulation Manufacturers Corp.	121
International Machine Works	229
International Nickel Co., Inc.	44
International Resistance Co.	61a, 61b, 64a, 64b
Jensen Mfg. Co.	37
Johnson Co., E. H.	243
Jones Div., Howard H., Cinch Mfg. Corp.	231
Kahle Engineering Co.	251
Karp Metal Products Co., Inc.	161
Kenyon Transformer Co., Inc.	38
Kester Solder Co.	150
Knuffel and Esser Co.	3
Knights Co., James	212
Lampkin Laboratories, Inc.	251
Lavoie Laboratories	133
Leitch Co., Inc. G. H.	241
Leukurt Electric Co.	140
Lewis Engineering Co.	237
Linde Air Products Co.	244
Lord Manufacturing Co.	39
Machlett Laboratories, Inc.	137
Marnavox Co.	193
Marnecord, Inc.	174
Mallory and Co., Inc., P. R.	66, 119
McGraw-Hill Book Co., Inc.	175
ME Manufacturing Co., Inc.	287
Mosinee Paper Mills Company	160
Murray Hill Books, Inc.	243
Mycalex Corporation of America	190, 191

HANDY & HARMAN
82 FULTON ST., NEW YORK 7, N. Y.
Agents in Principal Cities
Bridgeport, Conn. • Chicago, Ill. • Los Angeles, Cal.
Providence, R. I. • Toronto, Canada

These two low-temperature silver brazing alloys provide every property essential to both current-carrying connections and structural joints in electrical work. High strength and ductility, high electrical conductivity, strong resistance to oxidation and corrosion — you get them all when you braze with EASY-FLO and SIL-FOS. And the combination of low working temperature, extreme fluidity and silver content exclusive with both alloys, give you these results with substantial savings in time, labor and cost. BULLETINS 12-A AND 15 give you full details. Write for copies today.

••make them faster, better, at lower cost with **EASY-FLO** and **SIL-FOS**



Little parts

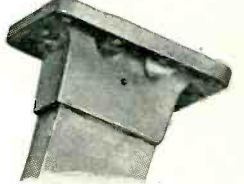

Big parts

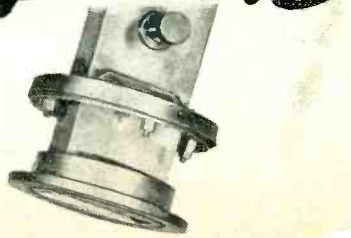

the expense of radio. There are, roughly, ten times as many parts such as resistors and capacitors in the average television set as in the average radio receiver, so makers of these components are feeling little pain. On the other hand, television receivers still use only one component such as a loudspeaker, so unless and until unit sales become comparable with those achieved in the radio business in recent years some component-part manufacturers will be unhappy.

Television will eventually be a bonanza to all of these boys but temporarily it may cause something of a revolution in the parts business.

It Seems To Us that during the war everybody and his brother ground crystals. Now they are winding coils.

Receiver Sales by RCA licensees during the first half of 1948 totalled 8,606,057 units, worth \$328,413,690. Here's the way the total broke down:

Type	Units	Dollars
<i>Electric</i>		
Table (under \$12.50 billing price)	1,415,531	\$13,256,747
Table (over \$12.50 billing price)		
A-M	2,286,923	42,569,939
A-M/F-M	152,720	5,731,705
F-M (including converters)	44,389	1,211,081
<i>Consoles</i>		
A-M	53,855	3,542,348
A-M/F-M	9,928	793,121
<i>Table-Radio-Phonos</i>		
A-M	352,313	16,354,665
A-M/F-M	8,654	573,467
<i>Console-Radio-Phonos</i>		
A-M	373,873	35,376,577
A-M/F-M	350,911	54,514,481
<i>Battery</i>		
Portable A-C/D-C	1,253,492	23,047,960
Table	171,574	4,576,992
Consoles	254	10,653
<i>Auto</i>	1,654,854	52,950,657
<i>Television</i>		
Converters		
Radio Table Models	181,638	35,477,011
<i>Radio Consoles</i>		
Direct Viewing	44,413	10,294,232
Projection	6,795	4,090,976
<i>Radio Phonos</i>		
Direct Viewing	43,850	17,476,145
Projection	1,356	1,002,756
<i>Phonographs</i>		
Phono Only	141,998	2,897,059
With Radio Attachment	3,645	191,711
<i>Without Cabinets</i>		
A-M	30,873	1,201,113
A-M/F-M	21,102	1,073,207
Television	1,127	209,087
TOTAL	8,606,057	\$328,413,690

Transmitter Makers will want to sharpen their pencils on this one: There are approximately 300 f-m broadcast station construction permits on the FCC's books. It is a good bet that most of these

people have already selected their gear. Less than 100 new applications are on file.

By contrast, a more liberal attitude on the part of the Commission toward new a-m station applicants, and a flock of applications for permission to increase a-m power, is swelling this market. And applications for television licenses are, as is well known, jamming clerical and other facilities.

Still more important: orders for transmitters for purposes other than broadcasting, particularly f-m transmitters, are pouring into most plants.

Just To Prove (if proof is necessary) that this columnist is not infallible note that in August the following brash statement was made: "In Australia 45 firms make radios but only one makes tubes." This we hasten to amend (after being jogged by our friend E. W. Burnett of Philips Electrical Industries of Australia Pty. Limited) to read: "In Australia 45 firms make radios but only *two* make tubes."

Sidelight on the GE story featured in October *ELECTRONICS* is the difficulty we had determining the precise location of 'Electronics Park' with respect to the center of Syracuse. The boys up there said it was north and slightly east (as well they might since at least one company circular says so in uncompromising black and white) while a map, straightedge and our own keen eye said it was north and a gnat's eyebrow west.

Exercising our usual editorial judgement in the face of what could easily become a crisis, we have decided that for us henceforward the Park is just plain north.

Latest Example of unconscious humor on the part of our drafting department was a slip in the lettering on a block diagram, which we fortunately caught before making a cut. The original drawing called for the words *Repetition-Rate Multivibrator*. This came out *Reputation-Rate Multivibrator*.

A handy device, no doubt, but not one for which we can suggest a practical design approach.

If you need Radio Parts...



in quantities suitable to Volume Production...it may pay you to call upon the Design Engineers of

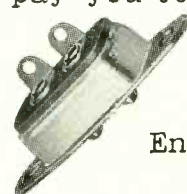

United-Carr and its subsidiaries. They have helped many manufacturers

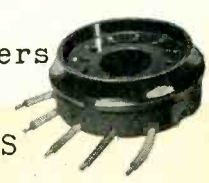

- ★ CUT COSTS
- ★ SPEED PRODUCTION
- ★ TURN OUT FINER FINISHED PRODUCTS

UNITED-CARR FASTENER Corp.
 CAMBRIDGE 42, MASSACHUSETTS

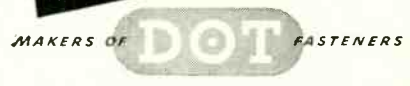



NEW!

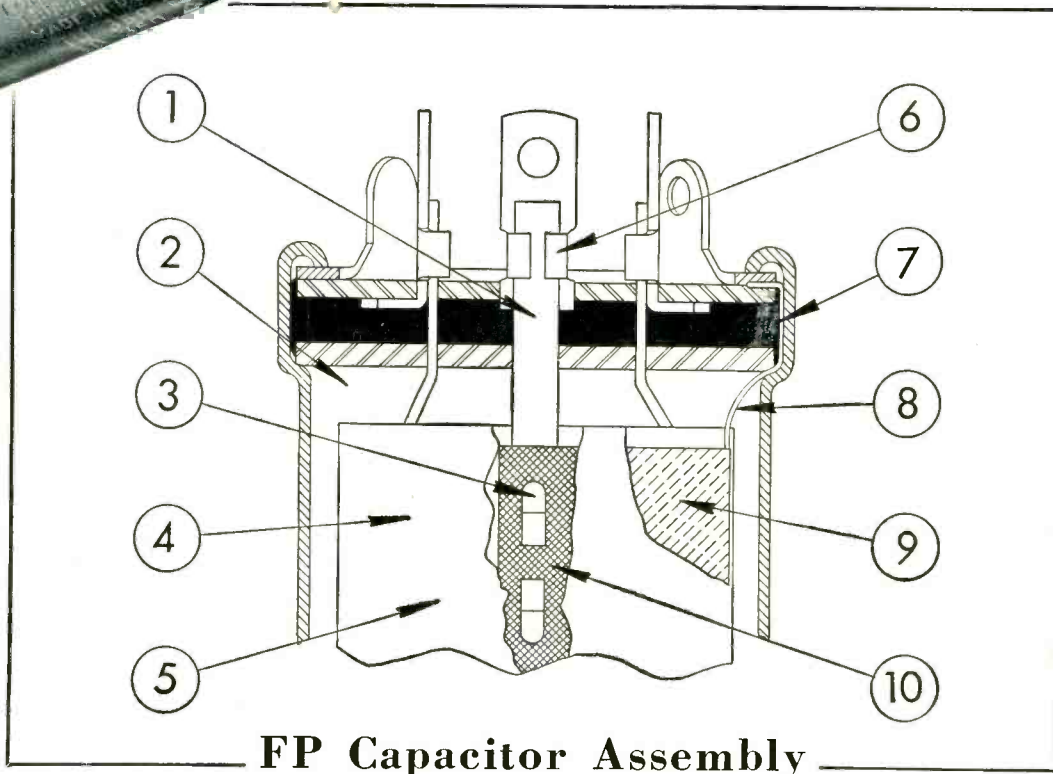

FP Capacitor Assembly

For the past ten years Mallory FP Capacitors have set new standards of dependability. Now new improvements make them more reliable than ever.

- ① New design anode tabs cannot break from vibration.
- ② Ample air space retained for gas expansion at elevated temperatures.
- ③ New staking method between anode and tab permits higher discharge currents.
- ④ Improved high surge separator material better at high temperatures.
- ⑤ Unique processing improvements provide still better performance at 85°C. No voltage derating required by Mallory FP capacitors at this temperature. (Including the 450V rating.)
- ⑥ Lower tab to terminal contact resistance for sensitive circuits.
- ⑦ Extra heavy rubber seal for high temperature and ripple conditions with venting feature preserved.
- ⑧ Heavier cathode tab for better tab to ring weld, lower resistance and more rugged mechanical construction.
- ⑨ Special etched cathode (all voltages) reduces loss of capacity under high ripple conditions, lowers RF impedance and remarkably reduces intersection coupling.
- ⑩ Increased FP anode ratio of 12 to 1 at 450V and 15 to 1 at 150V provides better design factors.

Still cost no more. Mallory FP capacitors have given exceptional performance at prices comparable to ordinary capacitors. These new improvements have all been accomplished without extra cost to the user.



Yours for the asking!

Send for the Mallory Capacitor Catalog, which contains useful data on all types of Mallory Capacitors—sizes, electrical characteristics, test measurements, mounting hardware.

P. R. MALLORY & CO. Inc.
MALLORY CAPACITORS
 (ELECTROLYTIC, OIL and WAX)

P. R. MALLORY & CO., Inc., INDIANAPOLIS 6, INDIANA



CROSS TALK

► **STRATOPIX** . . . The argument for Stratovision has taken a new turn in the discussion now centering on the expansion of television into the frequencies above 475 mc. As proposed for use in the present commercial channels, airborne transmissions were open to objection on two grounds: First, Stratovision produces a uniform field strength which would provide rural service, but probably could not overcome the high noise levels in outlying cities. Second, one Stratovision station would put off the air a score of ground-based stations on the same channel and thus would foster monopoly. But television on uhf is a different story. The uhf noise level in cities is not so high, so more uniform coverage would be obtainable. Second, it looks as though a ground-based uhf station would have so limited a range (see p 68, this issue) that it would be difficult to cover suburban areas, let alone rural districts. Thus the question of monopoly is overshadowed to a large extent by technical considerations. A comprehensive field test is in order to test Stratovision's capabilities in the uhf band.

► **ARGUMENT** . . . We thought Jeremiah Courtney's "What's Wrong with U. S. Frequency Allocations?" (p 73, August) would start something. It brought a rejoinder from A. L. MacIntosh of the FCC, published in this month's Backtalk column (p 240). We recommend a careful reading of both sides of the argument.

► **ANDB** . . . The Air Navigation Development Board is an agency deserving every support of the electronic industry. Its purpose is to guide and support the development of a system of air navigation and traffic control, the so-called "common system" which will assure safe all-weather flight in military and civil aircraft. Administered jointly by the Secretaries of Defense and Commerce, it will bring together the requirements of the Navy, Air Force and the civil airlines, lay out specifications for equipment and let contracts for development of some 30 items of electronic equipment ranging from ground radar to auto-

pilots. In approximately ten years ANDB plans to spend 80 million dollars on research and development, and Congress has looked favorably on its plans. When the final system is proved in, the amount spent for production of the equipment will run into many hundreds of millions of dollars. This huge program is essential to the future expansion of aviation, which is now stymied by its inability to meet heavy schedules in bad weather. Aviation and electronics have wrestled with this problem for ten years or more. The all-out effort to solve it looms big; it should keep a large segment of our industry busy for the next decade.

► **PARTICLES** . . . Time was when the electron and proton sufficed to describe the structure of our material world. Then came the positron. Then, a decade ago, it became impossible to ignore the neutron. For a while these four particles held the stage to themselves. The neutrino was suggested but, being virtually impossible to detect, it has remained a figment, a dream particle. But lately the cosmic-ray physicists have bumped into the meson, and the flood gates are down. We have positive mesons and negative mesons, mesons of several different masses, all transitory, living long enough only to leave a track in a cloud chamber. Most lately we have the "heavy component" of cosmic rays.

Understandably, the discoverers of these latter-day particles have tended to label them "fundamental." But other physicists, clinging to the hope that nature has a simple core, say it is only a matter of time before mesons will be found to consist of aggregations of electrons and positrons. We hope so too. Things are tough enough without multiple-valued mesons cluttering up the landscape.

Whatever the future may hold, there is some comfort in the fact that, since electronics began, only two types of particle have amounted to anything in practical electron tubes, electrons and ions. If we add the absence of an electron, the "hole" of the transistor, we have the lot, so far as practical electronic engineering goes.

The PROSPECTS

JTAC reports to FCC that service on 475-890 mc is possible only with high field strengths, and predicts megawatts must be radiated by ground-based stations to give results comparable with present service. Suggests study of Stratovision, satellites

WHERE to find additional spectrum space for the burgeoning television broadcasting industry is one of the most perplexing questions now facing the FCC. To explore the prospects of expansion into the uhf band from 475 to 890 mc, the Commission held a hearing late in September and invited the Joint Technical Advisory Committee (JTAC) to present evidence. The JTAC report, a 200-page document, contained an analysis based on information collected by IRE and RMA committees.

The conclusion reached by JTAC is that television on 475-890 mc cannot hope to provide the same grade of coverage over as wide an area as the present channels from 54 to 216 mc offer unless a radically different form of broadcasting, such as Stratovision or satellite stations, is adopted. This sweeping conclusion is based on the propagation characteristics of the uhf band, coupled with performance characteristics of the uhf band and uhf equipment.

The first point made by JTAC is that high field strengths will be required for uhf service. The FCC rules establish a field of 500 microvolts per meter as adequate for residential-rural service on the 54-216 mc channels. The report shows that a field strength ten times as great, or 5,000 microvolts per meter, will probably be required for the same grade of service in the 475-890 mc band. This increase is based on the fact that the effective heights of uhf antennas are smaller, the transmission-line losses substantially greater, and the noise inherent in uhf receiver circuits considerably greater than on the presently-used vhf channels. Thus 2,650 microvolts per meter would be required to produce a 30 db signal-to-noise ratio at the viewing screen, using a dipole at 475 mc, 50 feet of 300-ohm twin-lead cable, and a receiver with a 13-db noise figure.

This figure applies to 6-mc black-and-white service comparable to the present commercial practice. A wideband color-television service at

the opposite end of the band (890 mc) would require 20,000 microvolts per meter, even if a directive antenna having a voltage gain of 4 were used. The report indicates that there is much room for improvement in antennas, transmission lines and receivers.

In city districts, the FCC rules provide a field strength ten times that for residential districts, to overcome man-made noise on vhf channels. On uhf channels such man-made noise is not so prominent, so the same increase in field strength may not be required. But a value between 5,000 and 50,000 microvolts per meter would be required for city service on uhf channels.

Coverage Problems

The remaining question is whether such high field strengths can be established at any great distance from the transmitter, using presently available power levels. The answer is definitely in the negative. The RMA Television Transmitter Committee reported to JTAC that the maximum power available from existing tubes, over a 6-mc channel, is 2,000 watts at 475 mc and 500 watts at 890 mc. An antenna power gain of 10 is immediately available, so the effective radiated power ranges from 5 to 20 kw, depending on the position in the band in which the transmitter operates. Such low power levels cannot produce a 5,000 microvolt-per-meter field at a distance of 20 miles, let alone at the 40-mile range typical of present performance on vhf channels.

These conclusions are based on the Norton propagation formula

HOW TO EXPAND?

Television broadcasting today presents a troublesome paradox. In late September, of the 124 television stations authorized by the FCC, less than 40 were on the air. Yet the industry already sees a shortage of channels. Over 300 additional applications for television station licenses await action, and in many heavily populated districts the supply of channels is exhausted. All this, despite the fact that no television station is today meeting its expenses.

To find room for more stations, the FCC is considering the uhf band now reserved for experimentation with color and high-definition monochrome service. The pros and cons of uhf operation were analyzed by JTAC at the Commission's request, with the results here described. Whatever the outcome, to secure maximum service from the proposed new channels, many new techniques must be explored

for UHF TELEVISION

and on measurements of field strength made from an experimental transmitter on the Empire State Building, which operated on 510 and 910 mc. Along one radial, the 5,000 microvolt-per-meter contour was found to fall at 15 miles, despite the fact that the antenna height was 1,060 feet and the figures were converted to an effective radiated power of 100 kw. Along other radials the required field strength was propagated out 30 miles, but fell far short of the 50 miles predicted by the Norton formula.

Even assuming that the Norton formula is applicable to the uhf band, and using the nominal value of 500 feet for transmitting antenna height, the report shows that 5,000 microvolts-per-meter can be delivered to 40 miles only if 214 kw of effective power is radiated. This power is at least 10 times that available from existing experimental equipment. In contrast, the Norton formula predicts, and experience verifies, that 50 kw radiated from a 500-foot antenna at 65 mc will radiate the 500 microvolts-per-meter required for vhf service to 42 miles.

Perhaps most surprising is the fact that when the experimental results from the Empire State transmitter are averaged and substituted for the Norton formulation, similar performance could be obtained (5,000 microvolts-per-meter at 40 miles) only if the effective radiated power is in the range from 5 to 20 megawatts. As the report states, this is more power than has ever been radiated in any broadcast service in any region of the spectrum, and beyond foreseeable attainment of the future.

The report concludes from this evidence that conventional ground-based transmitters may not be suitable for uhf television service and suggests the possibilities of airborne transmitters and satellite

stations be investigated as alternatives.

System standards (number of lines and frames, bandwidth, type of sync signals, modulation, etc) are necessary before uhf television service can be instituted. An investigation conducted by an RMA subcommittee revealed that the present commercial standards (6-mc, 525-line, 30-frame picture) are technically feasible for use in the uhf service and if adopted would permit existing vhf receivers to receive the new service with the addition of a frequency converter and a uhf antenna. Since one objective of the study was to find ways of expanding the present service, such compatibility with existing equipment is evidently a basic requirement. But it is possible that modifications of the existing standards, and possibly wholly new standards, could be set up to provide a superior service, while still permitting existing equipment to receive the service. JTAC recommends that this possibility be carefully studied, in the immediate future, before adopting system standards for uhf tests.

The need for development of a color-television service must not be forgotten in the expansion of monochrome service, the report warns. It recommends that the FCC continue to reserve space in the uhf spectrum for the experimental development of color and high-definition monochrome service. No system standards for such wideband services are proposed, however, since JTAC considers that these systems are not yet ready for commercial operation.

Equipment Availability

Investigations by IRE and RMA committees revealed that no commercial equipment for transmission or reception of uhf television is now available, and indications are that from 1 to 3 years will be required to develop such equipment to the

point of commercial production. One encouraging report was that a new water-cooled tube, capable of producing 10 kw of power at 890 mc, is under development and may be proved in by next year.

Further measurements of propagation effects (especially tropospheric propagation which may cause serious interference far beyond the normal interference range) are required before an allocations plan can be set up. JTAC recommends that such measurements be made during the 1 to 3 year period required for the production of transmitters and receivers suitable for the band. This study should include a detailed field test of the field strengths required for residential and city service, the interference protection ratios required for co-channel and adjacent-channel stations, and the coverage attainable with available transmitter power. Moreover, the special capabilities or limitations of airborne and satellite stations in these respects should be investigated.

Plan for Future Hearing

The JTAC report concludes with a recommendation that another hearing be set by the FCC in approximately six months to receive additional evidence on propagation and coverage. At this hearing, and in the light of additional information, definite systems standards (either the existing standards or variations of them compatible with existing receivers) should be decided upon. The number of channels in the uhf spectrum and the portion of the spectrum to be used should also be decided at this time.

Acting on this information, the industry can then proceed to develop equipment and transmission methods best adapted to uhf service and the service can be instituted commercially as soon thereafter as the propagation studies are completed.—D.G.F.

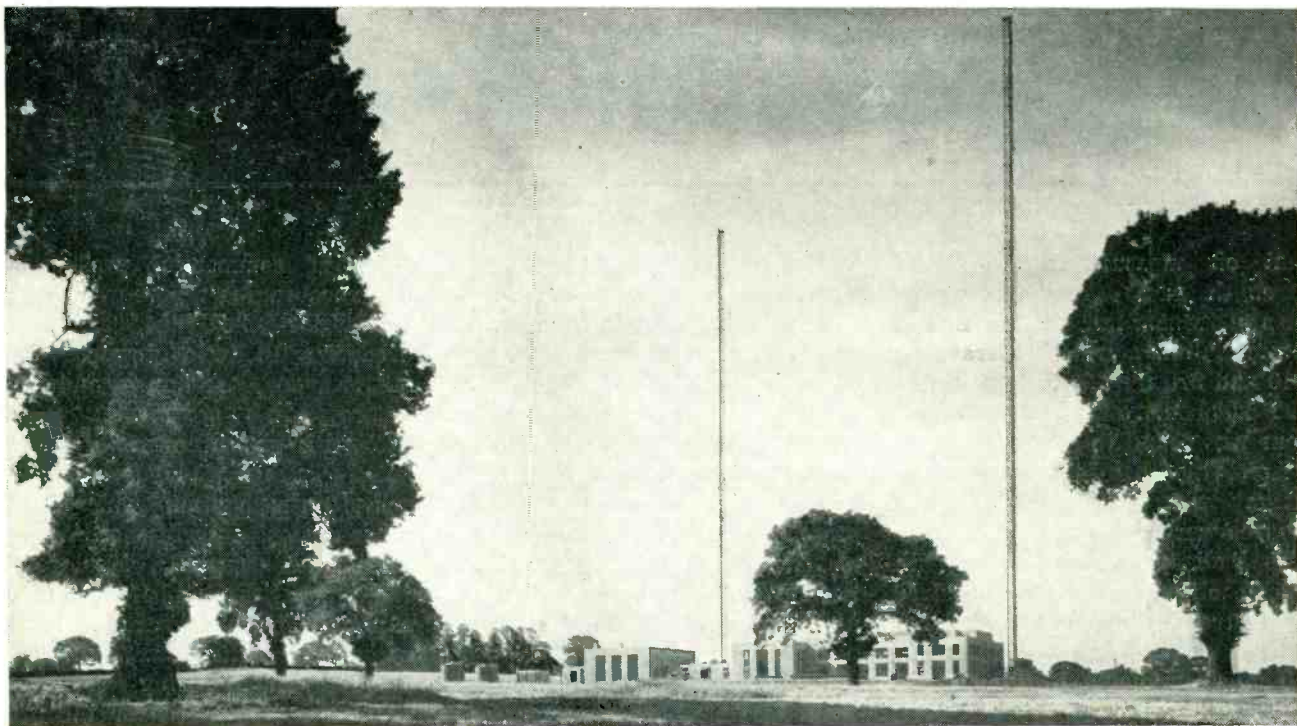

BBC 200-kw station at Droitwich, England, operating on 200 kc

INTERNATIONAL

A review of world-wide practices indicates the international character of all European radio broadcasting and the extent of wire-network public-address systems used in many countries. Despite exploitation of radio as a propaganda medium, the potentialities of broadcasting as known in the U. S. and Canada have barely touched much of Europe

BY ITS VERY NATURE, broadcasting is international. Yet few engineers seem to have either the time, or the inclination, to regard it as such. Stuck away in offices working a slide rule, or watching meters at the transmitter, the broadcast engineer too often sees only the domestic side of the picture. For him, the FCC is the god to be appeased, and the creator of the rules under which he operates. NARBA is a word which comes into the conversation when the going gets really technical, but not many stop to think what it means or how it affects their bread and butter.

Yet without it the conditions of the North American ether would be chaotic, and within a very short time many stations would be forced to close down owing to excessive interference. The Standards of Good Engineering Practice and the Rules and Regulations of the FCC are not the composition of only that body, but reflect the contractual obligations proposed by the North American Radio Broadcasting Agreement, which is adhered to by the U. S., Canada, Cuba, Mexico, Newfoundland, the Bahamas and Bermuda.

The system of allocating radio

frequencies to the countries of the world requires much more space to give even a brief description than is available here. Moreover, to do justice to the great amount of work and thought which these conferences and conventions entail, the history of their growth would have to be included.

As far as domestic and North American region operations are concerned the most vital controls and regulations spring directly from NARBA, and indirectly from the International Telecommunications Conventions which are held periodically. The most recent one



Changing a 50-kw tube in EBC final amplifier. Dolly speeds work and avoids damage to equipment

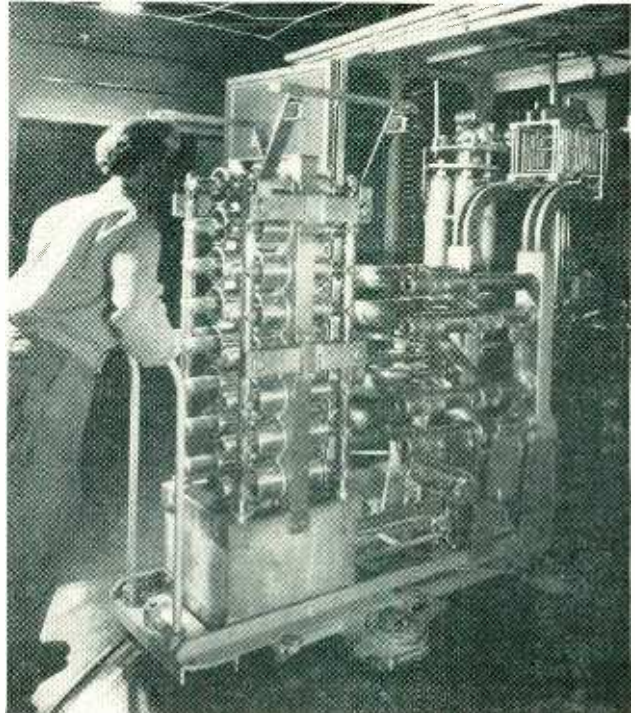

One of several pretuned final tanks used at Skelton, England being wheeled into position

BROADCASTING

Table I—License Fees for Private Canadian Broadcasting Stations

By **JOHN H. BATTISON**

*Allocations Engineer
American Broadcasting Co.
New York, N. Y.*

concerning the broadcast engineer was the Atlantic City Convention. Up until October 2, 1947, the convention of Madrid, 1932, had governed the radio transmissions of most countries of the world. On January 1, 1949, the operations of 72 countries will be affected by the changes made in the International Union of Telecommunications.

The actual allocating of frequencies and recording of requests is the job of the International Frequency Registration Board, which is composed of eleven members and is charged with the equitable allocations of frequencies and supervision

Class, and Power of Station in Watts	Service Radius in Miles	Population in Service Radius	License Fee
Class A			
100 or less	18	Under 25,000.....	\$ 50
		25,000 and under 50,000.....	100
		50,000 and under 150,000.....	250
		150,000 and under 500,000.....	400
		Over 500,000.....	500
Class B			
250	24	Under 25,000.....	100
500	31	25,000 and under 50,000.....	200
1,000	37	50,000 and under 150,000.....	300
		150,000 and under 500,000.....	500
		Over 500,000.....	700
Class C			
5,000	61	Under 100,000.....	500
10,000	72	100,000 to 500,000.....	1,000
		Over 500,000.....	4,000
Class D			
15,000	77	Under 500,000.....	3,000
		Over 500,000.....	4,000
Class E			
20,000	82	Under 500,000.....	5,000
25,000	87	Over 500,000.....	7,000
Class F			
50,000	100	Under 1,000,000.....	8,000
		Over 1,000,000.....	10,000
Class G			
50,001 and over			Fee determined by Order in Council

Table II—Facilities of Major Countries

Country	Operation	Freq and Max Power in kw	Number of Stations	Number of Receivers	Notes
Afghanistan	Government	h-f 20	4	—	Planned for all to commence in 1948
China	Government	m-f 100	62	—	
England	Government	h-f 35	16	—	This does not include tele or f-m. Synchronized operations, 10 stations from 1 to 60 kw in one group, seven groups all told, mostly groups of 2 stations. One group consists of two 100-kw stations. Separate license required for car radio
		m-f 200	53	11,233,500 includes 43,500 tele licenses as of Feb. 1948	
		h-f 100	31		
France	Government. Also commercial prewar. Final policy not yet definite	m-f 100	47	8,000,000 approx includes estimated 2,000,000 unregistered	French stations suffered extensive damage when the Germans retreated, but reconstruction progress has been good
Germany (American Zone)		m-f 100	6	8,789,008	Western Allies plans are for eventual return of operations to Germans. These exclude occupation recreational networks. License fees of 2 marks monthly are imposed
		h-f 1	3	Nov. 1947. These are approx figures	
(British Zone)		m-f 100	6	approx figures	
		h-f 25	1		
(French Zone)		m-f 50	5		
		h-f 1	1		
(U. S. S. R. Zone)		m-f 100	9		
Holland	Final postwar policy undecided. Prewar advertising was allowed	h-f 12	1	1,424,318 includes 492,046 relay subscribers	
		l-f 100	1		
		m-f 60	7		
Iceland	Government, but about 30 min of time daily is sold at 1 kroner per word, for advertising	h-f 40	6	34,692	Government obtains about one third of its income from advertising, also has full powers to curb interference and assists rural districts in radio upkeep
		l-f 100	1		
		m-f 1	1		
Italy	Advertising 2.89% of total programs	m-f 100	29	1,900,000	At present there are 3 networks: The Red, Blue, and Short-wave
Japan	Government and commercial, similar to Australia and Canada	h-f 50	7	Oct. 1947	Final allocation plans now being worked out
		h-f —	New plans call for 108		
Luxembourg	Commercial	l-f 150	1	42,468	License fee 72 francs (Belgian) collected annually by postoffice. Used for anti-interference work
		h-f —	1		
Norway	Government company	m-f 100	16	566,000	License fees average 20 kroner annually; where reception is poor reduced to 5 kroner, plus tax when buying receivers. Until 1940 advertising was carried. The company assists listeners by providing wind chargers where electric power is not available
		h-f 100	5		
Poland		—	—	675,000	
South Africa	Government	m-f 10	16	Dec. 1947	Includes Transvaal, Cape Division, and Natal Division. Programs in English and Afrikaans
		h-f 2	11		
Spain	Government	m-f 200	25		
Switzerland	No advertising. Transmitters run by one organization, studios and programs by another—both semifederal	h-f 40	2		License fee is 20 francs. Operation of the radio systems is in accordance with the free spirit of the people of Switzerland
		m-f 100	6	922,959	
		h-f 100	16	47	
Yugoslavia	Government, no advertising	m-f 20	12	200,000	5 federated republics support their individual stations by license fees. Propaganda use to all parts of the world except China and Japan. N. America beam completed by 1951
		h-f —	2		
		l-f 50	10		

to ensure that they are used to the best advantage. All the documents of the IFRB are written in English, French, Chinese, Russian, and Spanish, with French as the official

language. The Provisional Frequency Committee (CPF) is the direct result of the Atlantic City Convention, and met at Geneva in January 1948 to prepare a new

international list of frequencies for the use of IFRB. In spite of these agreements, countries have been known to use more power than that authorized, or to jump frequencies.

Fortunately such happenings are relatively rare.

The Canadian system of broadcasting is very similar to that of the United States in that it allows private commercial broadcasting, but it also has its own government network system working in competition with the private broadcasters. The Department of Transport is the regulatory body in this instance, although the CBC actually passes on the applicants, thus, in effect, controlling its own competition. A fact which may have escaped the notice of a large number of U. S. broadcasters is the license fee which has to be paid for the privilege of operating a commercial broadcast station. This fee ranges from \$50 for a 100-watt station to \$10,000 for a 50-kw station, as seen in Table I. Plans are afoot to increase these fees. The listener also has to pay a fee of \$2.50, even in areas where reception of CBC stations is impossible.

The United States side will be familiar to all readers, but perhaps the European aspect may not be. In fact the writer has often been amazed by the many times engineers have asked what body exists in England and Europe similar to the FCC. In each case the answer is none; and as we shall proceed to show, the need for a similar regulatory body does not exist, owing entirely to the different approach towards broadcasting.

Human nature being what it is, and engineers being, by virtue of their common interest, of a similar type, it is only natural to expect, and to find, that radio has progressed along very similar lines in most countries. An advance in one phase in one country is matched by an advance in the same field in the next, and so on. Although individual differences may cause slight changes in equipment operation and layout, the principles of construction follow somewhat similar lines, as may be seen in some of the illustrations.

Operational Procedures

As a result of engineering parallels one might expect the business procedures and principles of the various nations to be similar. They are not. The U. S. and Canada

have somewhat similar operation, but there are not many countries that allow commercial broadcasting by private companies; although wherever the U. S. influence is felt, a trend towards commercial operation is noticed. In most nations of the world radio is the voice of the government, and is used as a propaganda tool by the party in power.

In general it will be noticed that the majority of countries do not permit sponsored or commercial broadcasting. However, a few favor limited commercial broadcasting along somewhat similar lines to the Canadian system. Generally speaking, where this type of operation is allowed, the government runs the broadcasting system and collects the revenue from it. Receiver license fees are collected even where sponsored broadcasting is the rule. As far as the writer has been able to ascertain, such is the practice in every country except the United States of America. In countries where commercial broadcasting is allowed, or advertising is accepted, the license fees are sometimes used for improvement of the service to listeners.

A large number of foreign countries have strict laws concerning the use of apparatus which causes interference to radio reception. And in these countries the authorities are empowered to trace it down, and cause the owners of the offending equipment to modify it at their own expense. As television becomes more and more general in this country, it appears that a similar measure may have to be invoked.

The incidence of relay exchanges, and "wire broadcasting", in Europe and other countries, is much greater than is generally realized. A number of factors contribute to this, among them being the extremely poor conductivities in many of the mountainous countries of the continent, the lack of facilities for the domestic construction of receivers, the lack of money, either by the government or the listeners themselves for providing equipment, and the extremely poor reception conditions obtaining in many places. An example is the Gold Coast of West Africa, where for five shillings a

month (\$1) a loudspeaker may be leased together with a wire connection to the local relay exchange. This is an ideal provision for the inhabitants and well within their means. In many parts of Europe high and medium-frequency carrier-current systems are used over power and telephone lines. Some of these relays provide only the program of the national station; others also act as local stations and provide programs from local studies in addition. Of course, the great disadvantage of all these systems is the dependency on a physical connection. In the event of war a large part of the population could be denied broadcast intelligence by a few skillful saboteurs. This possibility is particularly true of Russia and many of the eastern states of Europe. In some of the villages in these areas only one loudspeaker and receiver is available for perhaps 500 people.

The very nature of the terrain in so many parts of Europe is an added handicap. A glance at any map will show large areas of mountainous country where reception is extremely poor. In view of these handicaps, it is interesting to reflect on the large number of high-power stations in Europe. High power is considered to be 60 to 500 kw. In the writer's opinion there is no doubt that the European answer to the coverage problem is large-scale synchronized operation of high-power stations, thus providing a nationwide groundwave signal from nationally operated transmitters. Either by accident or design, the local station and program, such as are known in this country, are virtually nonexistent. Possibly it is by design, for single sources of high-intensity groundwave service can be used more effectively with one propaganda program to influence a country than a number of small stations with varying ideas of program content.

In this respect, the Balkan countries are the worst situated. Conditions of low income per capita and scattered population combine with extremely mountainous terrain to present a very difficult problem. Very rapid attenuation of groundwave is experienced in these small countries and they are usually too

small to utilize skywave for night service.

In certain countries where commercial and government broadcasting is allowed, operation is along rather similar lines to that of the CBC and the private broadcasters in Canada. For example in pre-war days, Radio Luxembourg on 232 kc with 150 kw, provided an excellent day and night signal to more than 50 percent of Great Britain. This station carried limited commercial programs in English, as well as programs addressed in the national tongue of Luxembourg. Other stations such as Radio Paris, Radio Lyons, Toulouse, Radio Normandie, and Hilversum on the medium-frequency band, carried sponsored programs for both home and overseas, that is, British Isles consumption. These stations enjoyed a popularity equal to or greater than that of the BBC stations, especially among the younger people who were more receptive to the dance and light music which formed the major part of the programs. The International Broadcasting Company programmed some of these stations, with operation by nationals of the countries in which they were located.

It is simpler to list those countries where receiver licenses are not required than to list those requiring one! America is the shining example of free listening, although the principality of Monaco with its three stations is likewise untaxed. As a result of this almost universal imposition of license fees, a fairly accurate check can be maintained of the number of listeners throughout the world. It is not difficult to evaluate illegal operations. In 1942, it was estimated that there were 400,000,000 listeners. This world total can be broken down to show 29,393,000 radio homes in the U.S.A., against 51,986,000 in the whole of Europe and Russia. The terrific impact of radio in Europe is only now commencing to be felt and as more sets become available great mass reactions may be expected.

A problem peculiar to a number of European countries, and one with which the United States is not faced, is the provision of programs and radio services to colonies, do-

minions, and protectorates. Sometimes this service is achieved by high-frequency transmission from the mother country for direct reception, relying on these broadcasts to combat adjacent country propaganda interference. An alternative is to build local stations and program them locally, supplemented by relays from home. The latter is better, for it insures a service not dependent on the ionosphere layer, and not requiring different frequencies for different times of day.

Practically every European country operates at least one low frequency transmitter between 150 and 285 kc together with high power up to 200 kw. This combination usually results in a large part of the population receiving a fairly reliable single program service. However, secondary service has to be depended upon to a much greater extent than it is in America, and as a result relay exchanges are numerous and extremely popular.

Table II presents a brief summary of conditions in a number of countries. A breakdown of U. S. broadcast operations is given in Table III.

European Problems

In France in 1944 there were approximately 34 stations under government and private control. At the end of the war there were only five of any considerable power remaining. At present, there are two countrywide networks known as the National and the Paris networks. Recently, a third program heard only in Paris and the suburbs has been added. This program may

later develop into a third network so that the combination will prove similar to the three BBC program services. Thirteen transmitters in the National network cover about 80 percent of the population and ten in the Paris network provide coverage of 66 percent. Some areas hear only one service.

In July 1947, a new coaxial cable was put into operation between Paris and Toulouse. This span of approximately 490 miles requires the use of 42 repeater stations. Unfortunately, no details are yet available concerning its frequency response. A new transmitter with a power of 100 kw operating on 895 kc went on the air September, 1947, at Lyons-Tramoyes, and it is believed this is the first new one to be built since the war.

Before the war, Italy maintained three networks consisting of 40 stations in the m-f-band varying up to 100 kw. Nine short-wave transmitters used power up to 100 kw for broadcasts to Italian-dominated territories.

Belgium provides a good example of the dual language problem. Before the war the state operated two 15-kw transmitters at Brussels providing programs for the Walloons and Flemings, in French and Flemish; and 16 small privately-owned stations carried sponsored programs for local and regional consumption. Today, Belgium is rapidly rebuilding a first-class system out of the ruin left by the war. A 1-kw f-m transmitter on 100.1 mc is operating at Brussels, with two or more planned for Antwerp and Liege. It is suggested that an f-m network may be set up at a later date. However, this does not affect in any way the instant plans for a complete a-m network providing nationwide primary service.

Czechoslovakian broadcasting is governed by the law of March 23, 1923, and the decree of February 8, 1925. These reserved to the State the right to grant concessions to the use of the ether. The Ministry of Post may grant to individuals the right to operate a station, but there have never been any such grants. The Czechoslovakian Broadcasting Company, in which the government holds most of the shares, is the only source of broadcasting in the coun-

Table III—Broadcast Stations in the U. S.

	July 1, 1947	July 1, 1948	Increase
A-M	1,795	2,034	239
F-M	918	1,020	102
Television	66	109	43
Television (experimental)	81	124	43
Educational	38	46	8
International	37	37	0
Remote Pickup	583	571	(-12)
Other	33	26	(-7)
Totals	3,551	3,967	416

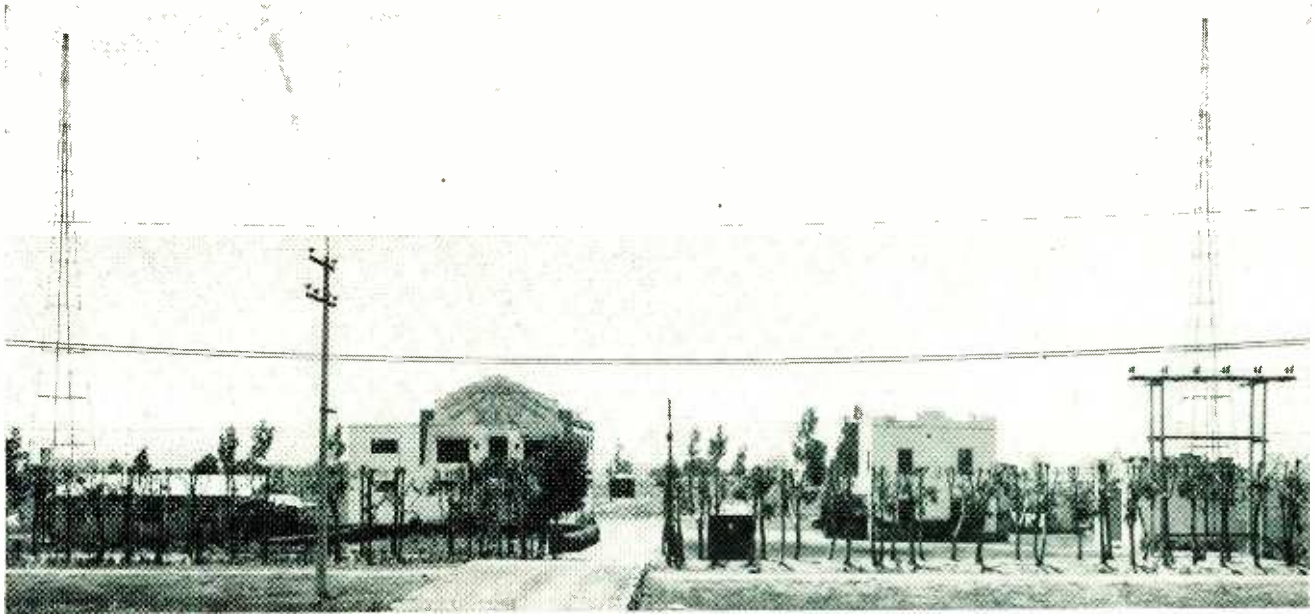

Mexican stations XEW and XEWW, showing a flat-top transmitting antenna (RCA photo)

try. Although nominally a private company, the State virtually controls its operations. About 1,600 people are employed and the organization is administered by a board of three members in Bohemia, five in Slovakia and the Ministry of Information. There are approximately 2,000,000 licensed listeners in the country.

Before the war, the Czechoslovakian radio system was one of the best in Europe. It operated eight stations, ranging up to 120 kw at Prague I. A number of these were destroyed during the war, but they are being replaced and in last December a new one of 100 kw on 1,204 kc was brought into operation near Presov. Incidentally, it is a European custom to identify stations by their location rather than call letters, and to carry it a step further, when two or more are located in the same town, they are labeled Prague I, Prague II, and so on. (This would be a little unwieldy in New York!)

At the time of writing, Poland operates nine medium-frequency transmitters and one low-frequency transmitter. The most powerful of these is Warsaw I with 50 kw on 758 kc. Licensing is employed as a means of raising money, but here it is rather illuminating to note that imprisonment is not provided as a penalty for failing to register, as in most countries, but a fine equal

to six months' license fee is imposed. The normal license fee is paid monthly, and is graded according to the size of the receiver, and the class of the owner, peasants, workers, clerks, pensioners, and military paying from half to two-thirds less than "other persons."

Polskie Radio, the official name of the organization, maintains a technical section which assists listeners in assembling or installing receivers. At the end of 1947 there were about 600,000 subscribers to wire broadcasting service. Special importance is attached to these installations in mining areas and it is intended thus to service ten large industrial centers in Silesia, where reception conditions are extremely poor.

Radio in Russia is, of course, a government service. The existence of two hundred different peoples in the Union, the extreme poverty of a large part of the population, and enormous areas to be covered all serve to direct radio towards group-listening practices. There were approximately 90 stations, one more than there were a-m stations in New York State, and 39 less than in California, at the end of 1947. The principal station, Moscow-Komintern, has a power of 500 kw; eleven others have 100 kw each. The exact number of shortwave stations for the Asiatic regions of the U.S.S.R. is not known since reports vary, but

well over 50 frequencies are used.

Radio reception in this tremendous area varies from place to place, but on the whole, conductivity is on the low side. To assist dissemination of programs a system of relay exchanges distributing the national program by wire was set up. In 1937 there were 7,000 of these exchanges, and by now there must be many more. They are similar in effect to United States local stations, except that they carry one-party propaganda only, and on a public-address basis.

Whenever radio men from different countries get together the conversation eventually turns to sponsored versus government radio. Without considering the merits of the case, the popularity of the American system is attested by the fact that last year a British company offered 300,000 crowns to the Danish Government to be allowed to put a transmitting station on the Faroe Islands. When this offer was turned down, the offer was increased to a figure of half their annual profits. So far as the author is aware, a decision has not yet been reached.

BIBLIOGRAPHY

- (1) *BBC Yearbook.*
- (2) *BBC Quarterly.*
- (3) *International Broadcasting Organization Bulletin.*
- (4) Arno G. Huth, "International Broadcasting."
- (5) O. Lund Johansen, "World Radio Handbook," Denmark.
- (6) *Le Radio Monde.*

ULTRASONIC

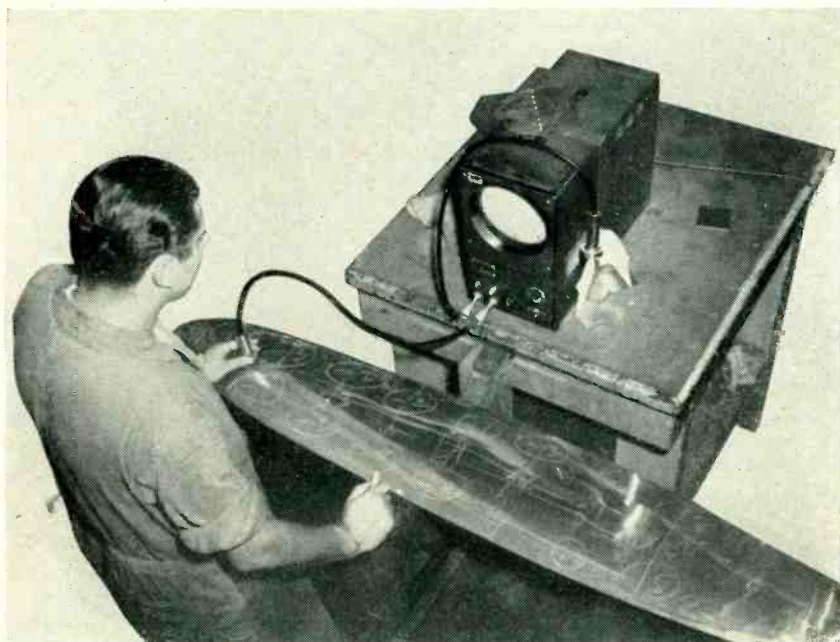

Wall thickness readings chalked in at various points on surface of hollow propeller

By **BENSON CARLIN**

*Product Research Supervisor
Sperry Products, Inc.
Danbury, Conn.*

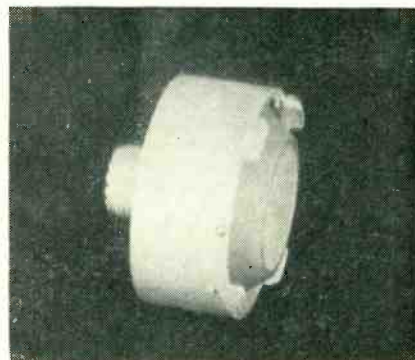

Crystal transducer searching unit

ULTRASONIC METHODS are being successfully applied to the testing of materials, using various instruments.¹ One of these is the Reflectogage, based upon the principles used in the Sonigage[®] originally developed by General Motors.

This device utilizes electronic methods of generating and receiving ultrasonic waves which are transmitted through the article under test. These waves are reflected within the material either by its opposite side or by a flaw or discontinuity, so that the thickness of most parts can be measured or the presence of flaws indicated. The accuracy of measurement can be made almost as great as the operator desires but in an ordinary commercial instrument such as the one

described it is approximately 2 percent of the thickness of the part, regardless of what the thickness may be.

Parts ranging from a few thousandths of an inch to four inches thick can be measured by variations of the basic method. The present commercial instrument reads directly in the range from 0.025 to 0.300 inch in steel and measures up to 4 inches by harmonic methods. It measures the thickness of material forming pipes, tanks, and vessels which can only be reached from one side of the wall. Such measurements were formerly made by drilling a hole and reading the thickness by mechanical means.

Not only metals but glasses and certain plastics can be measured. The use of the instrument is particularly valuable in cases where the material is formed into a closed vessel or long tube. For example, hollow propeller blades are being widely tested at present. It was formerly impossible to measure these sections by any known means. Lack of bond between similar or different materials can also be indicated either by changes in the amplitude or in the location of the

indications on the instrument. Eccentricity of bore can also be measured quickly and easily. Other applications are the testing of knife blades made of several sections bonded together, and of shell cases for separations within their wall sections.

Ultrasonic Principles

Ultrasonic waves commonly used in testing or gaging can be defined as sound or vibrational waves of very high frequency ranging between 100 kilocycles and 10 megacycles. For purposes of measurement, they may be considered to travel through a material with a fixed velocity that depends in a complex way upon the density and elasticity of the material.

The tables give experimental velocities and wavelengths for ultrasonic waves. Such waves are strongly reflected by an interface and will ordinarily return toward the source which produces them. Standing wave patterns are set up in the manner of electrical waves; the patterns are determined by the dimensions of the medium of travel and by frequency. The ultrasonic gage indicates the frequencies at

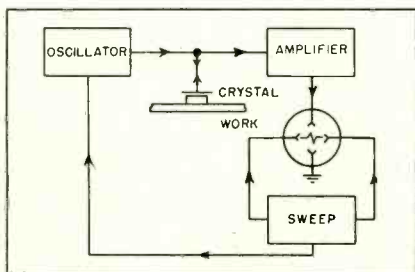

FIG. 1—Block diagram of equipment

THICKNESS INDICATOR

Nondestructive testing and gaging device gives visual display. Equipment comprises motor-driven variable frequency oscillator, contactor-initiated R-C sweep, crystal transducer, and cathode-ray tube. Graduated screens provide direct readings

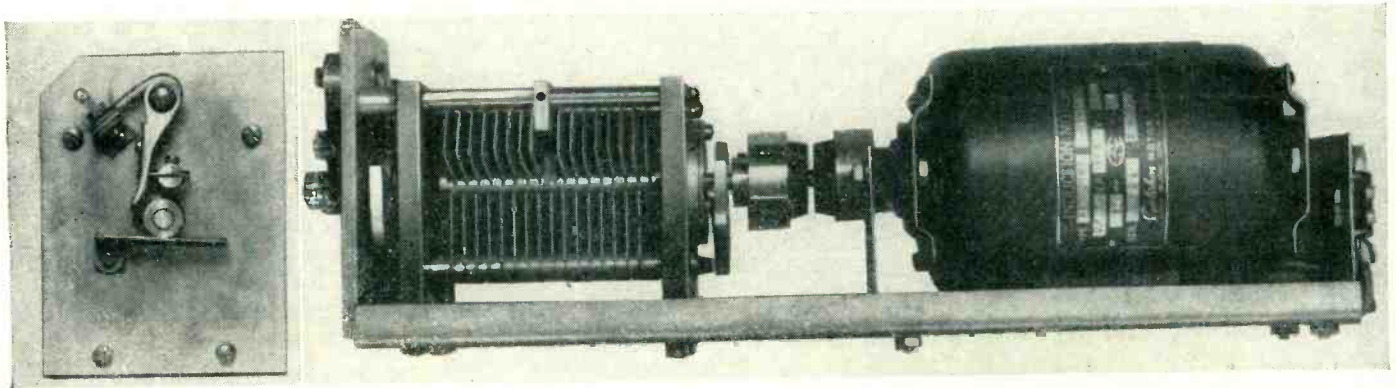

FIG. 2—Motor-driven capacitor for variable-frequency oscillator. Contactor for initiating sweep is shown in detail at left

which resonances take place. Because the velocity of travel is fixed, this action is equivalent to measuring the thickness of the medium, and the instrument may therefore be directly calibrated in thickness.

The operation of the instrument depends upon the fact that the amount of energy required to drive a system varies with its dimensions,—that is, resonances occur when ultrasonic wavelength has a specific relation to the thickness of the part and at this point there is a great increase in the vibration of the wall being measured. As a result, the plate current in the driving oscillator increases sharply. Any part can be put into such resonance depending on its dimensions, elastic characteristics, and density.

The lowest frequency at which resonance occurs is called the fundamental; and subsequent ones, harmonics. The frequency deviation between any two consecutive harmonic frequencies is equal to the fundamental. Therefore, when either the fundamental or the difference between two consecutive harmonics is known, the thickness (T , in inches) is determined by the relation $T = S/f$

where S is half the velocity of sound in inches per second, and f is the frequency in cycles per second. For steel this becomes

$$T = 121,000/f$$

Harmonic indications can be directly used to calculate thickness from the relation

$$T = R_1 R_2 / (R_2 - R_1)$$

where R_1 and R_2 are thickness readings of any two successive indications and R_2 is thicker than R_1 .

It should be noted that the thickness is read over a small area directly under the crystal. When the thickness varies sharply within that section, readings cannot be obtained. However, satisfactory results can be obtained even where a liquid or solid is contained against the reflecting surface.

Most materials transmit ultrasonic waves well³ and can therefore be measured. However, this is not true for materials which have very high internal damping or absorption. Most metals are in the first class, and each different material requires a separate calibration screen for use with the instrument. Alloys in which velocities vary greatly also require separate screens.

In cases where the medium under test is not electrically conducting, a metallic face must be placed over the front of the crystal search unit so that a suitable ground return can be made to the instrument. The interface between the crystal and work will interrupt the passage of ultrasonic waves unless it is filled in with some form of couplant such as transformer oil.

It is also important that the sur-

Table I—Velocities in Common Materials

Material	Velocity in cm per sec $\times 10^5$
Air	0.331
Alcohol	1.44
Aluminum	6.22
Bakelite	2.59
Brass	4.43
Copper	4.62
Glass	4.9-5.9
Lead	2.13
Magnesium	2.33
Mercury	1.46
Nickel	5.6
Polystyrene	2.67
Quartz	5.75
Steel	5.81
Transformer oil	1.39
Water	1.43

face of the part be fairly smooth. In general, most metallic surfaces are satisfactory or can be made so with a hand grinder. The back or reflecting surface must be smooth for if it is very badly pitted, the energy is scattered and it becomes difficult to make satisfactory readings. However, measurement can sometimes be made even when the reflecting surface is pitted by limiting the crystal to a small area.

The thickness of curved sections can also be measured. When the curvature is not great, flat crystals will give satisfactory indications. In other cases, crystals ground to fit the curved surface are necessary.

Electronic Principles

In a simple instrument of the resonance type, an oscillator with a milliammeter in its plate circuit might be used. A manually tuned variable capacitor can be slowly turned and the meter watched for changes in plate current. The thickness of a known part is calibrated against current dips and calibrations marked on a suitable tuning knob. Unknown parts can then be checked and the thickness read directly from the knob. This type of device would prove inconvenient because each successive test requires a laborious readjustment of the instrument before a reading can be taken.

A block diagram of the Reflectogage is shown in Fig. 1. It is an entirely automatic instrument, comprising a variable-frequency oscilla-

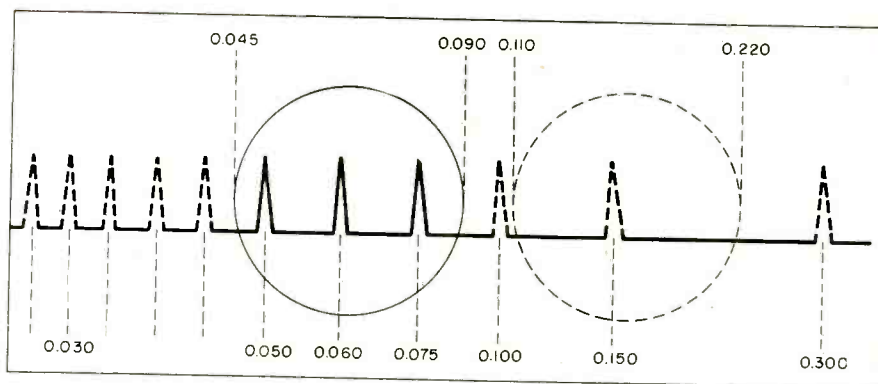

FIG. 3—Harmonic spectrum for steel piece 0.300-inch thick. Dashed and solid circles show indications for two different modes of operation

tor whose frequency is swept by means of a motor-driven capacitor, a sweep generator, an electronic sweep amplifier and signal amplifier, an indicator in the form of a cathode-ray tube, and a searching unit.

The oscillator produces electrical variations that are impressed across the crystal search unit. The rotation of the tuning capacitor continually changes the frequency of oscillation throughout an optional tuning range. The same mechanical device also contains a contactor or switch unit for producing a sweep voltage by discharging a capacitor through a resistor. This contactor, shown at the left of Fig. 2, is so adjusted that it fires the cathode-ray sweep at the beginning of each successive variation in frequency, that is, at the high-frequency end of the range, and the cathode-ray beam is swept horizontally across

the screen once for each revolution of the capacitor. As a result, each point along the beam corresponds to a particular frequency of oscillation. The scale is then calibrated in thickness for the parts under test, increasing from left to right. As energy is returned from the part, variations in the voltage across the crystal and across the amplifier cause the beam to be deflected vertically. These pips are the thickness indications.

If the oscillator were adjusted so that it operated over a very wide range the indications received would look like those in Fig. 3. However, in ordinary use it is convenient to limit the range so that only one marker or pip is received. This pip indicates a resonance in the material and although it may not be a fundamental, the range is ordinarily chosen so that it is. The instrument can be operated at almost

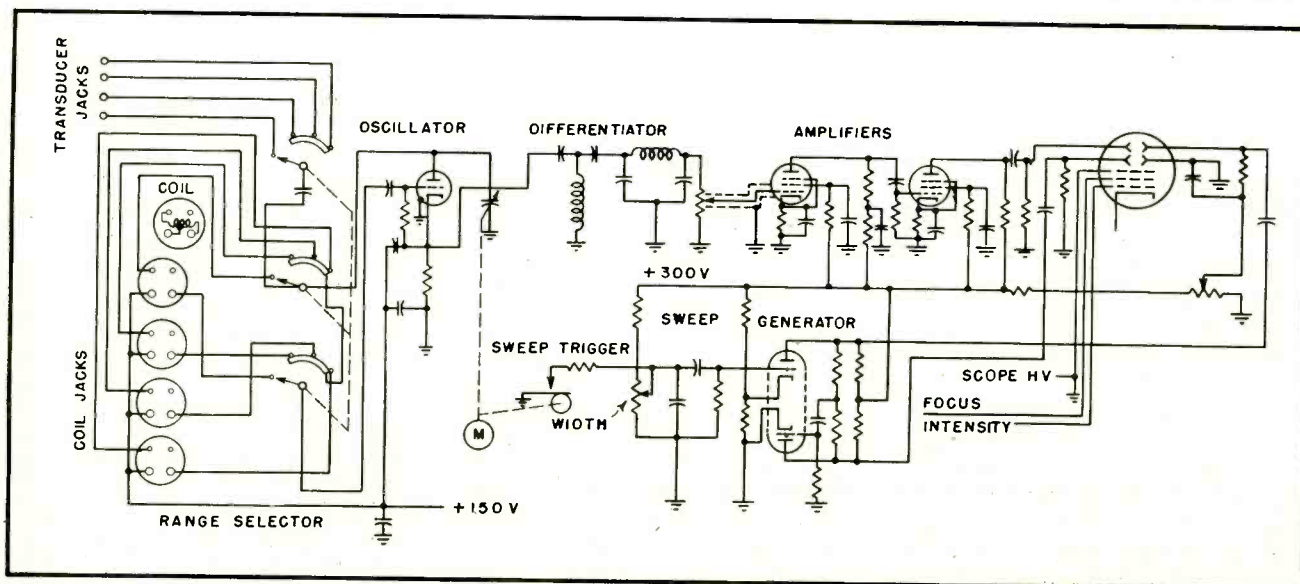

FIG. 4—Schematic circuit diagram of the Reflectogage. Conventional power supplies for plates and scope have been omitted

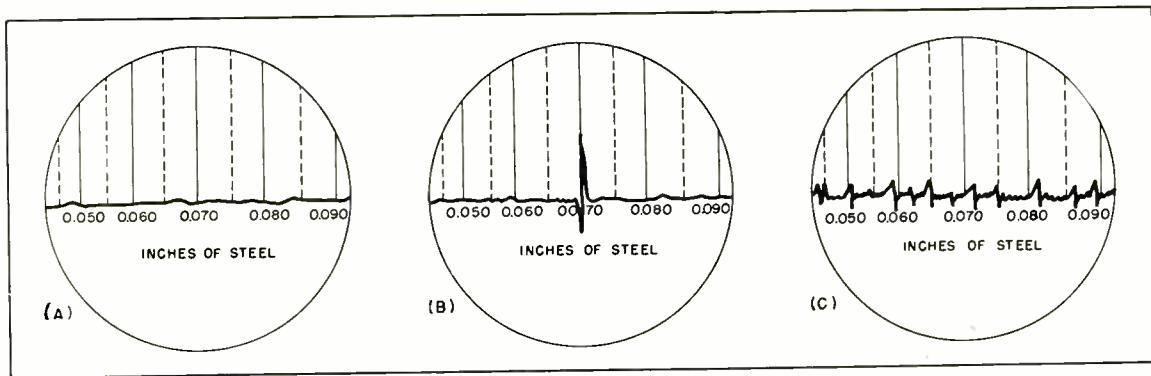

FIG. 5—Typical visual displays: (A) sweep without thickness indication; (B) fundamental thickness indication; (C) harmonic indications

any convenient frequency by substituting plug-in coils, but it is basically a 4-range unit. Range 1 is 0.025 to 0.050 in., Range 2 is 0.045 to 0.090 in., Range 3 is 0.080 to 0.160 in., and Range 4 is 0.150 to 0.300 in. A total frequency range from 400 kc to 5 mc is required.

Crystal Transducer

The energy produced by the electronic oscillator is impressed across the X-cut quartz crystal, illustrated, which transforms the electrical voltage into longitudinal physical vibrations. This crystal is usually either $\frac{1}{2}$ or 1 inch in diameter and mounted in a spring holder so that it is always supported at a fixed pressure against the work. The ultrasonic waves then travel perpendicular to the face of the crystal and are essentially limited in their cross-sectional coverage to a projection of the crystal face. The part of the work tested is therefore only that directly under the crystal and the instrument does not in any way integrate thickness readings over considerable areas.

The crystal resonance frequency is chosen to be somewhat greater than the highest frequency of electrical oscillation employed in that range so that the output is essentially constant and spurious crystal resonances do not appear as indications on the sweep.

Circuit Details

The oscillator output is connected to a vacuum-tube amplifier as shown in Fig. 4. The variations in plate current are separated, amplified, and finally displayed on the cathode-ray tube. The actual variations in plate current range from 2 to ap-

Table II—Wavelengths in Centimeters in Common Materials

Material	Frequency in megacycles			
	0.5	1	2.25	5
Air.....	0.0688	0.0344	0.0153	0.00688
Aluminum.....	1.244	0.622	0.277	0.124
Bakelite.....	0.518	0.259	0.115	0.0518
Brass.....	0.886	0.443	0.196	0.0886
Copper.....	0.924	0.462	0.206	0.0924
Glass.....	1.040	0.520	0.231	0.104
Lead.....	0.426	0.213	0.0947	0.0426
Mercury.....	0.284	0.142	0.0632	0.0284
Polystyrene.....	0.534	0.267	0.119	0.0534
Quartz.....	1.150	0.575	0.255	0.115
Steel.....	1.162	0.581	0.259	0.116
Transformer oil.....	0.278	0.139	0.0618	0.0278
Water.....	0.290	0.145	0.0645	0.0290

proximately 25 percent. The pips produced may be from $\frac{1}{2}$ inch to 3 or 4 inches in height but the instrument is ordinarily operated with the markers about $\frac{1}{2}$ inch high to give a clean base line and sharp vertical indications.

The general shape of the voltage variation in the plate circuit is that of a resonance curve and is therefore not so sharp as is desirable for indicating purposes. The signal is therefore differentiated by a series of filters and appears on the face of the tube as a sharp increase followed by an equally sharp decrease of voltage. The point at which the changeover from increase to decrease occurs is the one at which thickness is ordinarily calibrated.

Calibration is carried out by placing over the face of the cathode-ray tube a transparent plastic screen on which vertical lines are inscribed for various thicknesses. A different screen must be used for each material and also for each range of frequencies. Additional screens could

be made for operating at harmonic frequencies.

The appearance of the final signal may be more completely visualized from Fig. 5, in which the cathode-ray trace without resonance signal is shown at A; B is the trace with a single fundamental indication; and C illustrates the appearance of the trace with several harmonic indications. In B the thickness of the part is within the range of frequencies for which the instrument produces fundamental oscillations. At C the thickness of the part is much greater than the maximum fundamental possible on that range.

Work connected with the instrument was carried out with the aid of W. Doniger and T. C. Nehrbas.

REFERENCES

- (1) Norman G. Branson, Portable Ultrasonic Thickness Gage, *ELECTRONICS*, January 1948.
- (2) Wesley S. Erwin, The Sonigage, A Supersonic Contact Instrument for Thickness Measurement. Paper presented at the S.A.E. Meeting at Los Angeles, Calif., October 1944.
- (3) B. Carlin, Supersonic Wave Penetration into Materials, *Product Engineering*, October 1947.

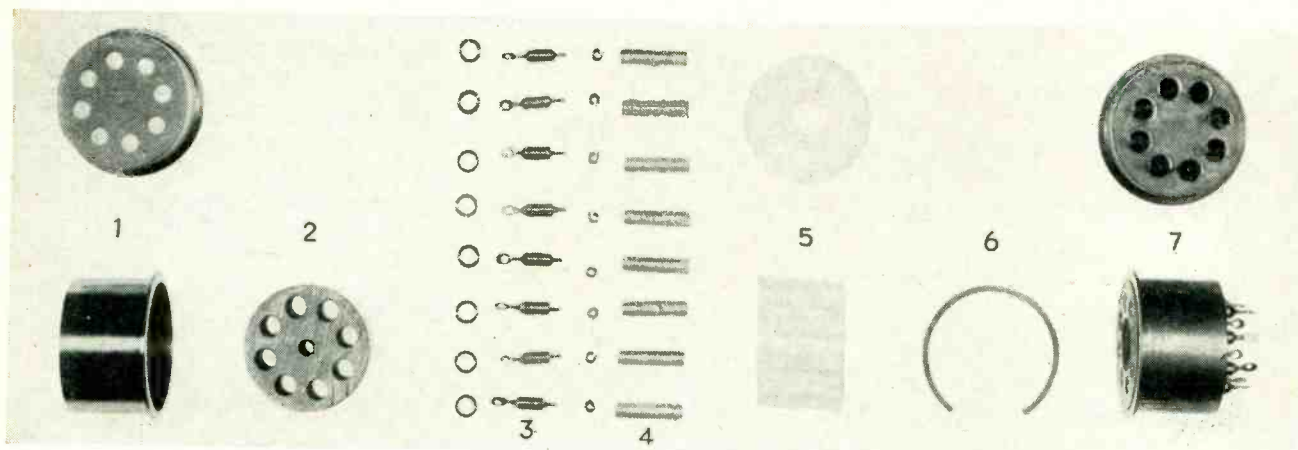

FIG. 1—Component parts (1, 3, 4, 5, 6, 7) and metal assembly jig (2) of a hermetically sealed octal socket

Hermetically Sealed Electronic Components

By **W. J. LEISS, G. R. MOLTRUP,
J. H. SLATON and A. H. WAYNICK**

*Ordnance Research Laboratory, School of Engineering
The Pennsylvania State College, State College, Penna.*

CONSIDERABLE EFFORT has been expended during and since the end of the war by numerous laboratories attempting to devise means of protecting electronic equipment in use against numerous deleterious environmental factors such as high humidity, fungus growth and salt water spray. The Ordnance Research Laboratory of the Pennsylvania State College, which is interested in electronic developments for the U. S. Navy, has designed hermetically sealed plug-in units, assemblies and complete devices.

By utilizing the components and techniques to be described it has been found possible to seal hermetically an entire electronic chassis as well as subassemblies and components. By so doing, the major problems of protection of electronic equipment during storage, shipment and use against high humidity, fungus growth and salt-water spray have been solved. The servicing problem has been greatly alleviated by the use of hermetically sealed plug-in components. In the case of more complex devices, the servicing problem has been further simplified by the use of hermetically sealed

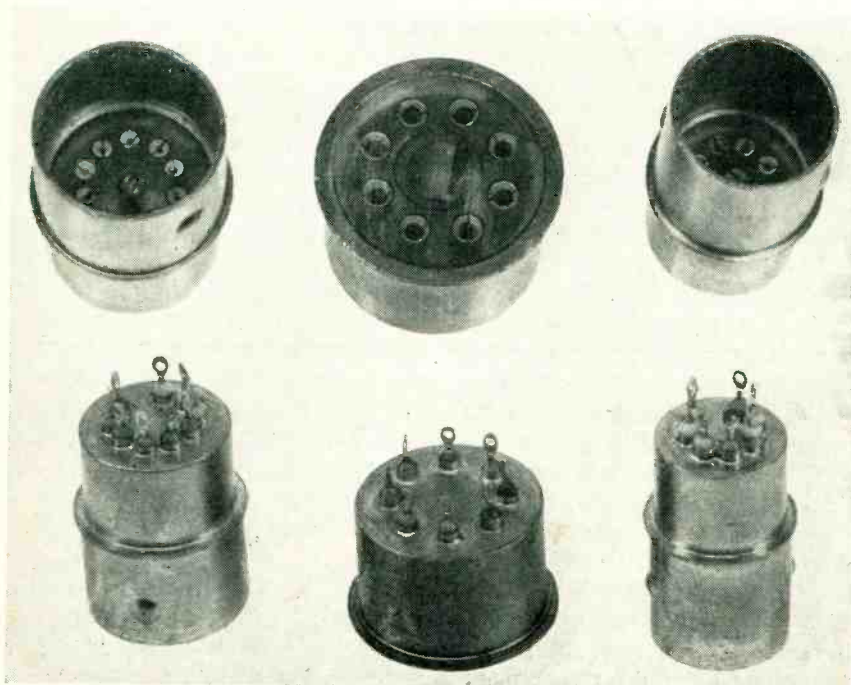

FIG. 2—Top and bottom views of assembled nine-pin, octal and seven-pin hermetically sealed sockets



FIG. 3—Plug-in oscillator tank circuit using the sealed construction

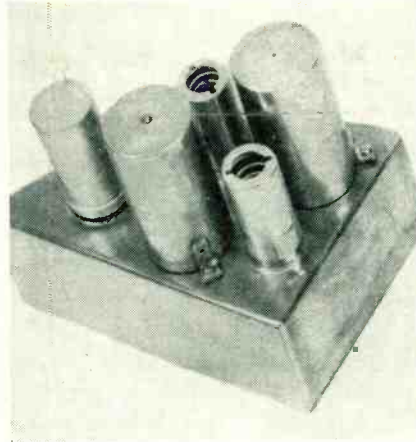

FIG. 4—Two-tube sealed subassembly that plugs into a larger chassis

Sealed plug-in units such as tubes and sockets, transformers, relays, capacitors and tuned circuits are utilized in construction of subassemblies and complete chassis that are also hermetically sealed to provide protection against high humidity, salt-water spray and fungus growth

plug-in subassemblies which, in themselves, may generally be so constructed as to be simple to test.

For relatively simple electronic devices all of the critical or high impedance circuits have been placed in one chassis, the entire chassis then being hermetically sealed. More complex devices have been broken into subassemblies which are in themselves constructed in plug-in type hermetically sealed containers. In either case the maintenance and/or servicing procedure, aside from replacement of tubes, transformers, relays and other standard hermetically sealed components, involves the replacement of the entire hermetically sealed chassis or subassembly in case of electrical or mechanical failure. By utilizing this construction, the problems of protection against humidity, fungus growth and salt-water spray may also be satisfactorily taken care of by proper choice of materials.

Sealed Sockets

Hermetically sealed tube sockets for octal and seven and nine-pin miniature types are made up from the components shown in Fig. 1,

and examples of the resulting sockets appear in Fig. 2. Use of these sockets results in a gas and vapor seal of the chassis interior relative to its exterior. The sealing is accomplished by means of glass and metal surfaces, with all materials exposed to the exterior so chosen as to avoid surface condensation leakage paths when exposed to humid atmospheres.

In mounting, a hole which is just large enough to permit entry of the socket body is punched in the chassis. The latter must be hot tin dipped to permit soldering. The socket is then placed in the hole and is supported therein by a protuberance at the top of the octal socket and near the center of the miniature sockets. The socket is then soldered into place with a solder ring and, if desired, by cylindrical soldering irons designed for this purpose. The portions of the miniature socket shells above the chassis surface fit standard shields.

As shown in Fig. 1, the socket body is a hot tin dipped brass shell, item 1. The feed-through insulators, 3, are a standard commercial

item. Pin receptacles, 4, are made from beryllium-copper rod which has been drilled, slit and silver-plated.

In assembly, the metal insert, 2, is placed in the shell to locate the terminals while they are being soldered to the shell. Items 3 and 4 are assembled and inserted into items 1 and 2 along with the appropriate solder rings as shown.

The entire assembly, 7, is preheated and then immersed, with the aid of appropriate jigs, in a bath of Crisco for approximately 30 seconds at a temperature of 550 F.

The socket terminals are sufficiently flexible to account for pin location variations from tube to tube. This is accomplished by slitting the terminal and by using a flexible lead-through insulator. The magnitude of the connector displacement is limited by the polystyrene spacer, 5. In assembly, the split ring, 6, is held tightly in the groove around the circumference of the spacer. The spacer and ring are inserted in the socket and, when seated, the ring expands into a groove in the shell.

The miniature sockets are assembled similarly except for a center shield pin screwed into the shell.

Plug-in Components

Certain electronic circuits and devices are most usefully constructed in the form of separate, hermetically sealed components which may be plugged into larger assemblies. Figure 3 illustrates a hermetically sealed plug-in oscillator tuner circuit. This circuit is plugged into a hermetically sealed octal socket so that it may be removed from the larger unit without affecting its seal. The components of the tuned circuit are vacuum potted in a can with a hermetically sealed header. The potting process is used primarily for mechanical strength since potting, by itself, does not form a satisfactory hermetic seal. The assembly is fastened to the larger units by screws through the two lugs. The screws fit into sealed studs.

Figure 4 shows an entire electronic subassembly which, in turn, is plugged into a larger unit which may or may not be hermetically sealed. Coil assemblies, tubes and

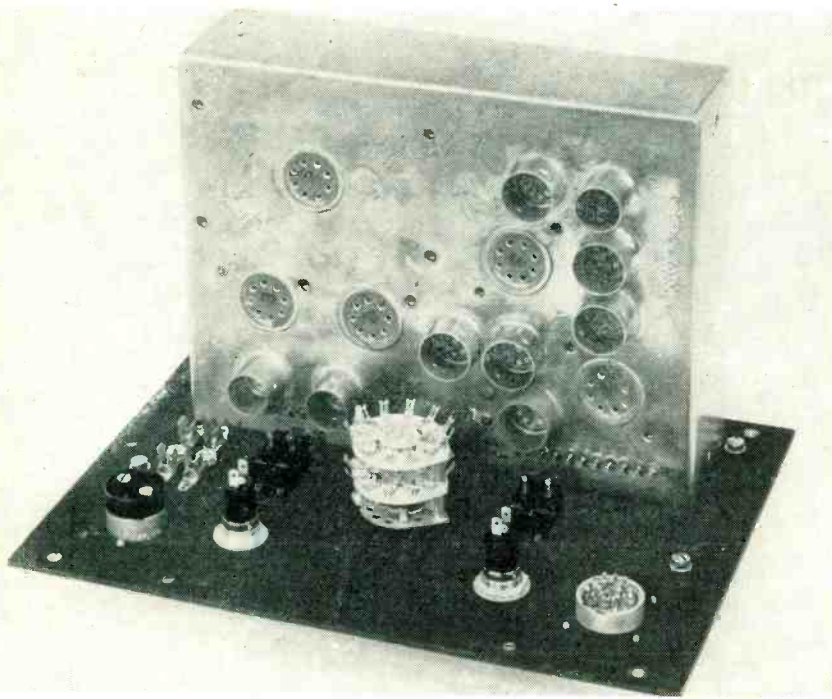

FIG. 5—Complete chassis before wiring. Connections to all major components are made through octal sockets

other sealed components which may require replacement are connected to the subassembly by means of the hermetically sealed sockets. The assembly is connected to the main unit through an hermetically sealed connector.

In case of failure, aside from tubes, coil assemblies, or similar plug-in units, the entire subassembly is replaced by a new unit. Thus, special packaging of spare units is avoided, and the circuit in the subassembly can usually be tested by relatively simple, perhaps plug-in, test equipment.

Hygrometer Indicator

It has been found desirable to incorporate an electric hygrometer in large assemblies involving many solder seals. It is also useful for preproduction tests of smaller sub-assemblies.

The hygrometer unit is installed inside the assembly to be sealed. One of its terminals is connected to the chassis ground while the other is connected to a lead-through sealed terminal. The hygrometer is used to check the drying process and, in larger units, further permits easy checking of the seal during the life of the assembly.

A relative humidity of six percent, measured at 130 F, results in satisfactory operation of most elec-

tronic equipment, as far as condensed moisture is concerned, when the equipment is operated at temperatures as low as -60 F. Consequently, commercial hygrometers have been chosen to operate over the relative humidity range of five to ten percent.

An electronic chassis comprising a test set for other electronic equipment will be described to illustrate the use of hermetically sealed components in a large assembly. All components except low-impedance circuits and power switches are mounted in a standard chassis box which is hermetically sealed.

With all top components removed from the chassis (Fig. 5), it is evident that construction is quite different from usual. The transformer leads are fed through an hermetically sealed octal socket and the transformer is fastened to the chassis with the aid of screws and hermetically sealed studs. Similar mountings are used for the relay, the electrolytic capacitor and the tuned circuits. Low-impedance and power leads are fed through the sealed lead-through terminals. The remaining sockets are for tubes and are also hermetically sealed.

All components are soldered into place before final assembly by solder rings and cylindrical soldering irons.

Resistor boards are fastened to the walls of the main assembly and held in place by rivets which are peened so as to fill an indentation in the assembly wall around the rivet hole. The rivet is soldered to the assembly wall so that a smooth exterior assembly wall surface is obtained. A hygrometer unit is permanently mounted in a corner of the chassis. Final sealing, except for two 1/32-inch diameter holes in the side walls of the chassis, is accomplished by placing a flat metal plate over the bottom of the chassis and flowing solder around its edge in contact with the chassis lip.

Sealing Procedure

As would be expected, it is necessary to dry out the interior of the chassis before making the final seal. The metallic surfaces, and some component surfaces, are covered by an adsorbed layer of water vapor which must also be removed.

In drying a chassis before final sealing, the entire chassis is placed in a heater where it is maintained at a temperature of 130 F for about thirty minutes. Dry air from a commercial air-drying unit is then forced into the chassis through one of the 1/32-inch holes left in the chassis sidewalls. This flushing process is continued until the hygrometer has indicated a relative humidity of six percent or less for at least one-half hour. At this time the two 1/32-inch holes are solder closed while the chassis remains in the drying oven. The sealing process is then complete.

This type of construction should be of use in geophysical prospecting, airborne and many other services where electronic devices are subjected to humid atmospheres, fungus growth and other deleterious conditions.

We wish to acknowledge the assistance rendered in this work by Dr. F. W. Dunmore of the National Bureau of Standards who so kindly furnished information concerning the procurement of suitable hygrometers. Professor E. R. Queer of the Pennsylvania State College Engineering Experiment Station contributed many helpful suggestions concerning proper methods of hermetic sealing and dehumidifying.

Road-Testing Gasoline

Electronic spark-advance indicator and tachometer provide a method of rating gasoline throughout the entire speed range, instead of at two speeds as is usually done in octane number determination

By R. R. PROCTOR

*Research & Development Laboratories
The Pure Oil Company
Northfield, Illinois*

THE OCTANE NUMBER or octane rating of automotive fuels has for years been determined on what is known as the CFR (Cooperative Fuel Research) engine, a single-cylinder variable-compression-ratio engine running at a slow speed, 600 rpm for the so-called Research Method and 900 rpm for the Motor Method. While this procedure is still standard in all laboratories, it does not give a complete picture of the fuel since rating is determined at only two points or speeds.

About 1936 or 1937 a supplementary procedure known as the Borderline Method of fuel rating was developed by means of which the octane rating of a fuel throughout the entire speed range could be determined. Briefly, the fuel rating is determined by plotting a framework of reference fuels and superimposing the unknown fuel on the framework to determine its octane rating at any speed.

All fuels are used in a test car in which the distributor governor and vacuum advance have been locked out and a manual control installed. The distributor is first set so that ignition occurs at a known point somewhere near top-dead-center of the piston stroke. With the car in high gear and running at 8 to 10 mph on a level road, it is accelerated at wide-open throttle and the speed of the engine at which the knock fades out is recorded. At least two check runs are made, or more if nec-

essary, until the same fade-out speed is agreed upon by two observers. The spark is then advanced two degrees and the procedure repeated, then two more degrees, and so on, until a complete curve has been plotted for speeds up to 70 miles per hour.

A graph consisting of a framework of five or six standard-reference fuels of known octane numbers is thus prepared and the curve of the unknown fuel can be plotted. From a comparison of curves the octane number of the unknown fuel at any speed can be obtained.

Some sort of instrumentation is required to determine the spark advance each time it is changed, or conversely, to set the spark at any given point accurately and easily. Also, since it is easier to work with engine rpm than with miles per hour, and since the standard speed-

ometer is not ordinarily accurate enough for this type of work anyway, an engine-rpm indicator is desirable.

It is necessary to know how far from top-dead-center the spark plugs fire, in degrees of crankshaft movement, and arbitrary limits of 60-degrees advance and 10-degrees retard can be assumed. A stroboscopic light can be used as an indicator but this is rather inconvenient when the driver or observer in the test car must know the spark-advance setting accurately while speeding down the road on a fuel test. Therefore, to bring the indication to the driver's seat, electronics is employed.

To get a reference point electrically, a magnetic pickup is fixed on the engine in such a position that small metal studs on the flywheel pass close to it and produce voltage

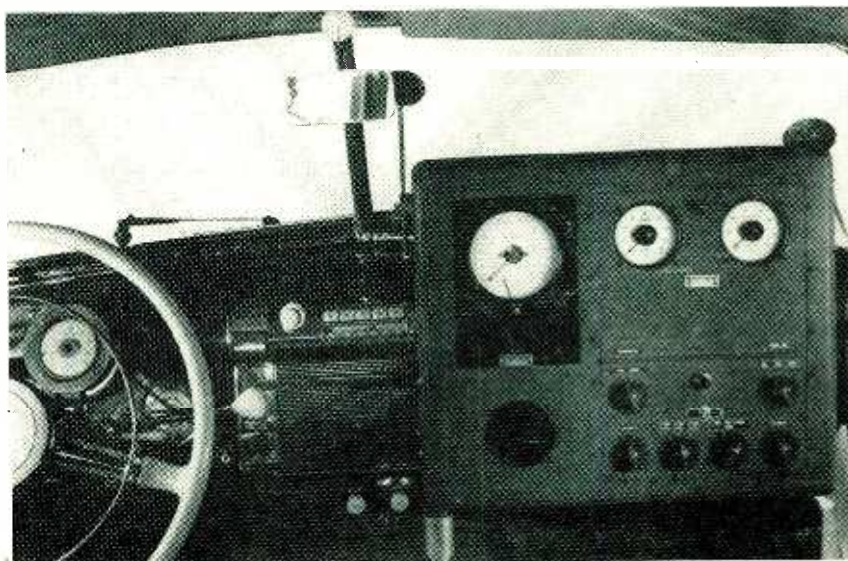

Mounted with other instruments in the test car, the electronic unit indicates engine speed and spark advance

pulses in the pickup coil two or three times per revolution. The arrangement is shown in Fig. 1. The pickup is a small reluctance generator consisting essentially of an Alnico magnet in a structure containing a $\frac{1}{8}$ -inch air gap, and a 1,000 to 1,500-ohm coil. The signal from the pickup is conducted to the interior of the car by a shielded wire.

The variable parameter in this problem is the ignition impulse and this is obtained from the ignition primary on the distributor. For a constant engine speed, therefore, two minute pulses of voltage are available in the car, the time interval between which varies as the ignition is advanced or retarded. These voltages are both amplified to give 3 to 4-volt pulses at the output.

A thyatron, A, is set up as in Fig. 2, so that when it passes current it will indicate on a meter in its cathode circuit. The circuit constants are adjusted so that the tube is cut off and no current passes unless the grid is made a volt or two positive. The output pulse from the pickup amplifier tube then permits thyatron A to fire. Since the plate supply for the thyatron is d-c, the grid loses control after firing and current passes continuously through the meter. The only practical way it can be stopped is by reducing the plate voltage to less than about 15

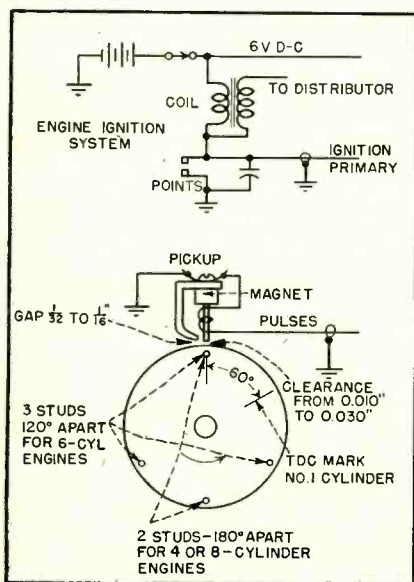

FIG. 1—Location of flywheel pickup studs for 4, 6 and 8-cylinder engines, and electrical circuits used to actuate the electronic equipment

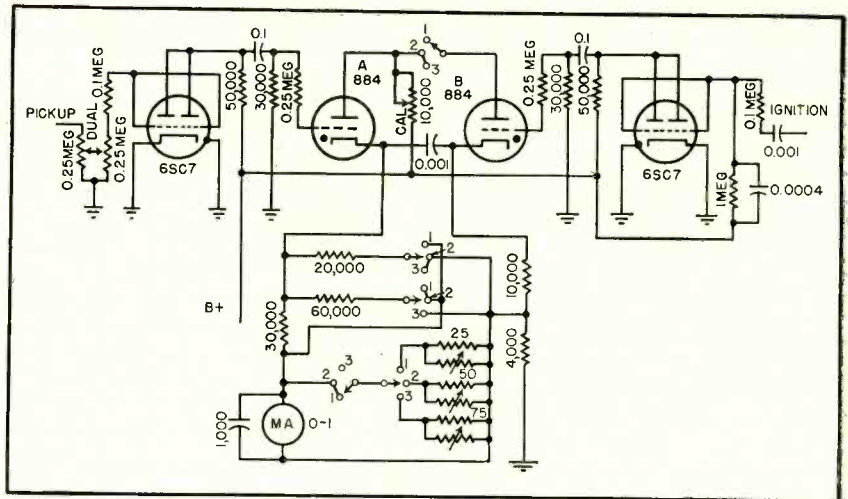

FIG. 2—Circuit for showing how far from top-dead-center the plugs fire

volts with respect to the cathode. To do this another thyatron, B, which draws plate current through the same plate resistor as thyatron A, is fired by the amplified voltage pulse from the ignition primary.

As thyatron B fires, the voltage drop across the common plate resistor increases suddenly, thus greatly reducing the plate voltage of thyatron A. At the same time, by means of a small capacitor connected between A and B cathodes, the cathode of A is given a positive pulse when thyatron B fires and becomes momentarily positive with respect to the plate. The tube is therefore extinguished and only the thyatron B passes current, which does not flow through the meter. Since the meter is no longer passing current, its needle drops back toward the left. And since the grid of thyatron B no longer controls, this tube continues to pass current to ground until the next impulse from the pickup amplifier trips thyatron A again. This extinguishes thyatron B by the process just explained, and current again starts to flow in the meter circuit.

Thus the meter receives current intermittently, and, with a capacitor across it, will indicate average current which is dependent in value on the ratio of the on-time to the off-time of thyatron A. This ratio is constant at any speed of the engine flywheel as long as the ignition timing or spark-advance setting is constant.

When the spark setting changes, the ratio changes accordingly.

Hence, the magnetic pickup is installed in such a way that a flywheel stud passes it and produces a pulse 60 degrees before top-dead-center on the No. 1 cylinder. Theoretically, spark advance from plus 60 to minus 60 degrees can be indicated on a meter with a zero-center scale. When the ignition is advanced to 60 degrees before top-dead-center, the ratio of on-time to off-time is theoretically one over infinity, or zero, and both thyatrons fire almost simultaneously. Thyatron A cannot remain ignited for more than an instant and hence it will pass practically no current. The meter, therefore, indicates almost zero current, so the bottom of the scale is marked 60-DEGREES ADVANCE.

Since we seldom are interested in more than 10-degrees retard, 10 DEGREES RETARD is made the top point on the scale and the meter is caused to read full current for this setting by juggling the series and shunt resistors. Now, using one pin on the flywheel, and with the ignition at say, 40 degrees before top-dead-center, the ratio of on-time to off-time is 40 degrees out of 360 degrees or 1 to 9, the pickup thyatron fires 60 minus 40 or 20 degrees before the ignition primary thyatron and the meter passes current for a certain period. The pulses are averaged and this average current point is marked 40-DEGREES ADVANCE. At top-dead-center, for example, the ratio of on-time to off-time is 60 degrees out of 360 degrees or 1 to 6, the meter reads still higher and this point is marked ZERO DEGREES. Thus the meter is calibrated from

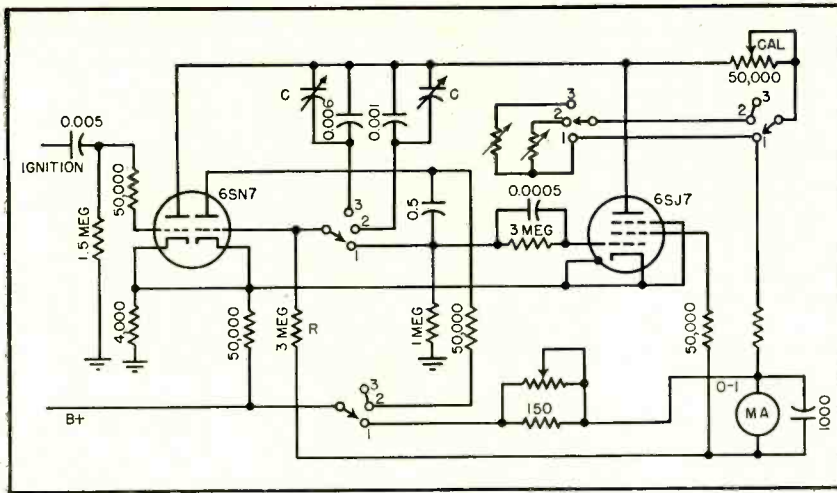

FIG. 3—Tachometer circuit for measuring engine speed

minus 10 degrees on the right to plus 60 degrees on the left, and the spark setting at any time can be read instantaneously on this meter.

With a constant voltage source for the plates, obtained from a vibrator and rectifier system operating on the 6-volt car supply, the instrument described indicates the spark setting at all times, inside the car.

Speed Measurement

Additional tubes integrate the ignition primary impulses and indicate them as average current on another meter calibrated in rpm to provide an electronic tachometer. The tachometer circuit is shown in Fig. 3.

The ignition impulse applied to the grid of one triode of the 6SN7 causes that triode to draw current through the meter and its series resistors. This applies a negative pulse to the grid of the other triode through one of the mica coupling capacitors, the capacitance of which determines the range. (Two scales are sometimes used, 0-1,000 and 0-5,000 rpm.) This pulse is amplified and applied to the grid of the 6SJ7, causing this tube also to draw current through the meter and its series resistors. The action is cumulative, resulting in a final current in the 6SJ7 limited only by the series resistors in the meter circuit. This current flows without change until the charge leaks off the mica coupling capacitor and the circuit returns to its original state with the 6SJ7 cut off. At this time, the second half of the 6SN7 is again

drawing full plate current.

The meter reads average current, which is quantity-per-unit-of-time, or engine speed. Resistor *R* and the mica coupling capacitors, with their adjusting trimmers *C*, determine the time of flow, which must be less than the time between impulses at the highest speed to be measured. For this circuit the time of current flow is approximately $0.7 RC$ second.

The complete instrument requires but two wires to a battery and two wires to the engine to give all the information needed in the test. Calibration can be made accurate to plus or minus 1 percent in speed and plus or minus 1 degree in spark advance at any speed or spark setting and under battery-voltage variations from 5.5 to 7.5 volts.

Other Details

On a 6-cylinder engine, 3 pickup studs on the flywheel provide three pickup impulses per revolution. This tripling of the current impulses to the meter allows decreasing the instantaneous load on the B supply and reducing the size of the capacitor across the meter. On an 8-cylinder car, four ignition impulses per revolution are obtained. Theoretically four studs on the flywheel could be used since the 70-degree range is less than $360/4$ or 90 degrees, but practically it is rather difficult to get four pins exactly 90 degrees apart on the flywheel. Hence 2 pins 180 degrees apart are used. In this case there is provided a pickup impulse, then 2 ignition impulses, before the next pickup pulse. The second ignition

pulse has no effect, however, as thyatron *B* is already passing current, having been tripped by the first impulse.

The total current through the meter is less than in the case of 3-stud 6-cylinder operation, so the resistor network in the meter circuit must be changed. A selector switch is incorporated in the panel which changes circuit conditions to allow one or two-stud 4-cylinder operation, 3-stud 6-cylinder operation or 2-stud 8-cylinder operation. This same switch also changes the resistors in the tachometer circuit.

A calibrating circuit is also incorporated to allow setting the meter to a definite point (zero degrees on the scale) at any time to compensate for tube aging and other factors. A gain control on the pickup line, and a check position on the calibrating switch permit setting the gain to a standard point without flicking the meter needle to one end or the other.

The B voltage for the instrument is obtained from a vibrator power supply which incorporates a T-4½ neon lamp, a 6SJ7 and a 6V6 connected in the usual voltage-regulator circuit. The load on the unit is very nearly constant and the input voltage is the main variable. The output voltage supplied to the tubes is nominally held to less than one-percent change for 20 percent or more change in input voltage.

The original circuits were designed around 1-ma fan-shaped meters. Several instruments have been built recently, however, using 2-ma or 5-ma concentric-scale meters, such as shown in the photograph. The basic circuits have necessarily been changed somewhat to accommodate the higher current, but the advantages of the longer easier-to-read scales more than offset the circuit complications involved.

BIBLIOGRAPHY

- Sidney Oldberg, Gilbert Way and J. B. Macauley, A Spark Advance Indicator and Knock-Rating Observations, *SAE Transactions*, p 521, 1937.
 R. J. Greenshields and L. E. Hebl, Additional Service Data on Effect of Ignition Timing, *SAE Transactions (Discussion)*, p 148, 1937.
 W. E. Drinkard and J. B. Macauley, Spark Advance and Octane Number—A Road Test Technique, *Jour. Soc. Auto. Engr.* 436, p 43, 1938.
 C. R. Wagner, W. B. Ross, L. M. Henderson and T. H. Risk, Improved Motor Fuels through Selective Blending, presented 22nd Annual Meeting API, Nov. 1941, San Francisco.

Composite Amplitude

High transmitter efficiency is combined with reduced bandwidth. The signal to one modulator is shifted 90 degrees. This, plus the inherent 90-degree phase difference between sidebands from p-m and a-m, cancels one set of sidebands

By

OSWALD G. VILLARD, JR.

*Acting Assistant Professor
Electrical Engineering Dept.
Stanford University
Stanford, Calif.*

A SYSTEM OF CARRIER MODULATION having several unique advantages compared with conventional double-sideband amplitude modulation has been developed. Although this new method produces substantially a single-sideband with carrier, the signal can be demodulated with negligible distortion in conventional receivers employing linear diode detectors. The bandwidth required for transmission is approximately half that of the double-sideband method. The maximum amplitude modulation required for communication, equally effective to that obtained with 100-percent double-sideband a-m, is 81.5 percent, resulting in a saving of 33 percent in audio power when plate modulation is used.

The system can be added to existing phase or amplitude modulated transmitters with very little trouble, and appears to be the simplest way to achieve the advantages of single-sideband transmission from the standpoint of simplicity in installation, adjustment and maintenance. The sole disadvantage of the system is the presence of an appreciable second-order sideband that is beyond the primary sideband and is capable of causing adjacent-channel interference comparable to that arising from a badly adjusted conventional transmitter. It should, therefore, be particularly interesting for low-power mobile and point-to-point communication where moderate ad-

jacent-channel interference can be tolerated, as in Fig. 1.

Basically, the system consists of combined amplitude and phase modulation with a 90-degree phase shift between the two audio modulating voltages. Because a-m and first order p-m sidebands are in radio-frequency quadrature, this arrangement can be made to cancel either the two upper or the two lower sidebands, as in the phase-rotation system of single-sideband modulation.

Sideband Structure

Operation of the composite system will be more readily understood after a description of its sideband structure for a single-frequency modulating voltage. The first problem is to select the degree of modulation for which the composite system will have a communication effectiveness equal to that of a carrier wave 100 percent amplitude modulated. It is necessary that the uncanceled first-order sidebands have a combined amplitude seventenths that of the reference carrier. This requirement arises because the receiver bandwidth is halved with the new system, hence the noise power received is halved. Because the two sidebands in a-m add directly, so far as detection is concerned, removing one has the same effect as cutting the sideband power to one-quarter its former value. Thus, for the remaining sideband power to be halved (that is, reduced as much as is the noise power when the receiver bandwidth is halved), the remaining sideband must have 0.707 times the reference carrier amplitude.

In the composite system, half of this sideband (35 percent) is con-

tributed by a-m, and half by p-m. Assume that 3,000-cycle p-m alone is acting on the carrier; an index of 0.75 radian is sufficient to give first-order sidebands of 0.35 times the reference amplitude. The resulting spectrum (amplitude vs frequency) is illustrated in Fig. 2A. If this phase-modulated radio wave is simultaneously amplitude-modulated 81.5 percent by a 300-cycle tone, the spectrum becomes that of Fig. 2B. It will be observed that a pair of a-m sidebands (shown with dotted lines for clarity) is generated about each component of the original p-m spectrum. The low frequency of the second modulation helps to make the situation clear. Note that the entire wave must be amplitude-modulated 81.5 percent in order to generate two sidebands on either side of the reduced carrier of 0.35, or the same amplitude as the first-order p-m sidebands.

Components Combine

We may now re-examine the spectrum when the a-m frequency becomes relatively high, say 2,900 cycles, illustrated in Fig. 2C. This representation of the sidebands shows what happens when the frequencies producing the a-m and the p-m become the same. The groups of sidebands merge, and the resultant sideband at each 3,000-cycle interval can be found by combining the components, taking the various phase relationships of each component into account.

Figure 2D shows the original p-m spectrum but with the relative phases of the components indicated by the direction of the vectors, for the instant at which the modulating voltage passes through a maximum.

and Phase Modulation

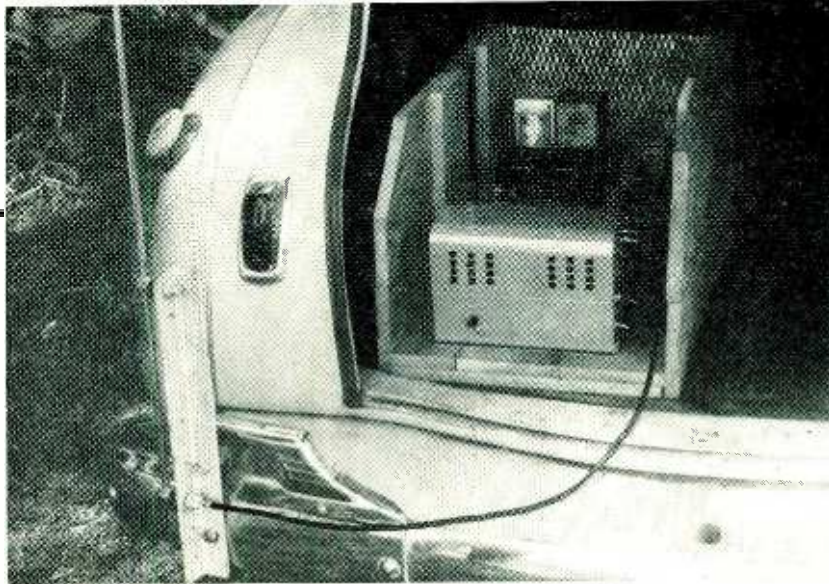

FIG. 1—Mobile single-sideband transmitter used by author to test dependability of unconventional modulation system that produces a signal which is easily demodulated by a conventional receiver

Figure 2E shows this spectrum with the addition of a-m sidebands corresponding to an audio voltage 90 degrees out of phase with that producing the p-m; however, for the sake of clarity these sidebands have been shown displaced from their correct position in the frequency spectrum. In Fig. 2F, the sidebands are given their correct position and phase, so that their resultant can be found. The final spectrum, phases once more disregarded, appears in Fig. 2G.

It will be seen that the first-order sidebands on one side of the carrier are nearly cancelled (cancellation can be made complete by a slight reduction in the percent a-m), while those on the other side add directly. Of particular interest is the relatively strong second-order sideband (0.22) on the same side of the carrier. The remaining higher order sidebands are negligible, being 20 db or more below the desired first-order sideband.

Modulation Distortion

The existence of a strong second-order sideband in the composite modulating system is not surprising when it is remembered that the envelope must necessarily be sinu-

soidal when all frequency components are taken into account. This must be the case since the shape of the envelope is solely due to the a-m portion of the composite modulation. If the carrier and the first-order sideband were taken by themselves, their envelope would be distorted, rather than a pure sinusoid. (For example, if carrier and sideband were equal in strength, their envelope would resemble the output of a full-wave rectifier.) It follows that the strong second-order sideband has the effect of removing a large portion of the envelope distortion which would otherwise be present. Because the other sideband components are 10 db or more weaker than the strong second-order sideband, it seems safe to assume that the envelope will be very nearly sinusoidal even when these components are neglected.

It is interesting to observe that when a true carrier-plus-single-sideband signal in which the ratio of sideband to carrier is 0.7 to 0.86, as in the situation under discussion, is rectified in a linear detector, the second harmonic distortion in the output is 18 percent. This is of the same order of magnitude as

the audio signal which would be produced by the rectification of a carrier of 0.86 and a second-order sideband of 0.22.

It therefore appears that when, in the composite system, only the carrier, first-order sideband and strong second-order sideband are accepted by a selective receiver or band-pass filter, the resulting signal will have an envelope substantially free from distortion.

Furthermore the distortion will be low at all modulation levels. While the p-m portion of the second-order sidebands will decrease faster than the modulation level, thus tending to remove the difference between these sidebands at low signal levels, at the same time the distortion accompanying linear detection of a single first-order sideband tends to decrease as the modulation depth decreases. Thus the distortion (and the level of the spurious higher-order sidebands as well) will never exceed the full modulation situation illustrated in Fig. 2G.

We may now consider a typical example. Assume a voice communication system having a maximum modulating frequency of 3,000 cycles. A receiver having a 3,000-cycle bandwidth and a linear diode detector can be tuned so that the carrier falls at the proper edge of the passband. For all modulating frequencies below 1,500 cycles, the strong second-order sideband falls within the receiver passband, and detection is substantially distortionless. For modulating frequencies between 1,500 and 3,000 cycles, the second-order sideband will fall outside the receiver passband, and detection will be accompanied by roughly 18-percent distortion.

As far as adjacent-channel interference is concerned, there will be a band of frequencies 3,000 cycles wide outside the 3,000-cycle bandwidth of the system in which spurious sidebands will be heard of an amplitude equal to that which would be present if the radio wave were amplitude-modulated in the

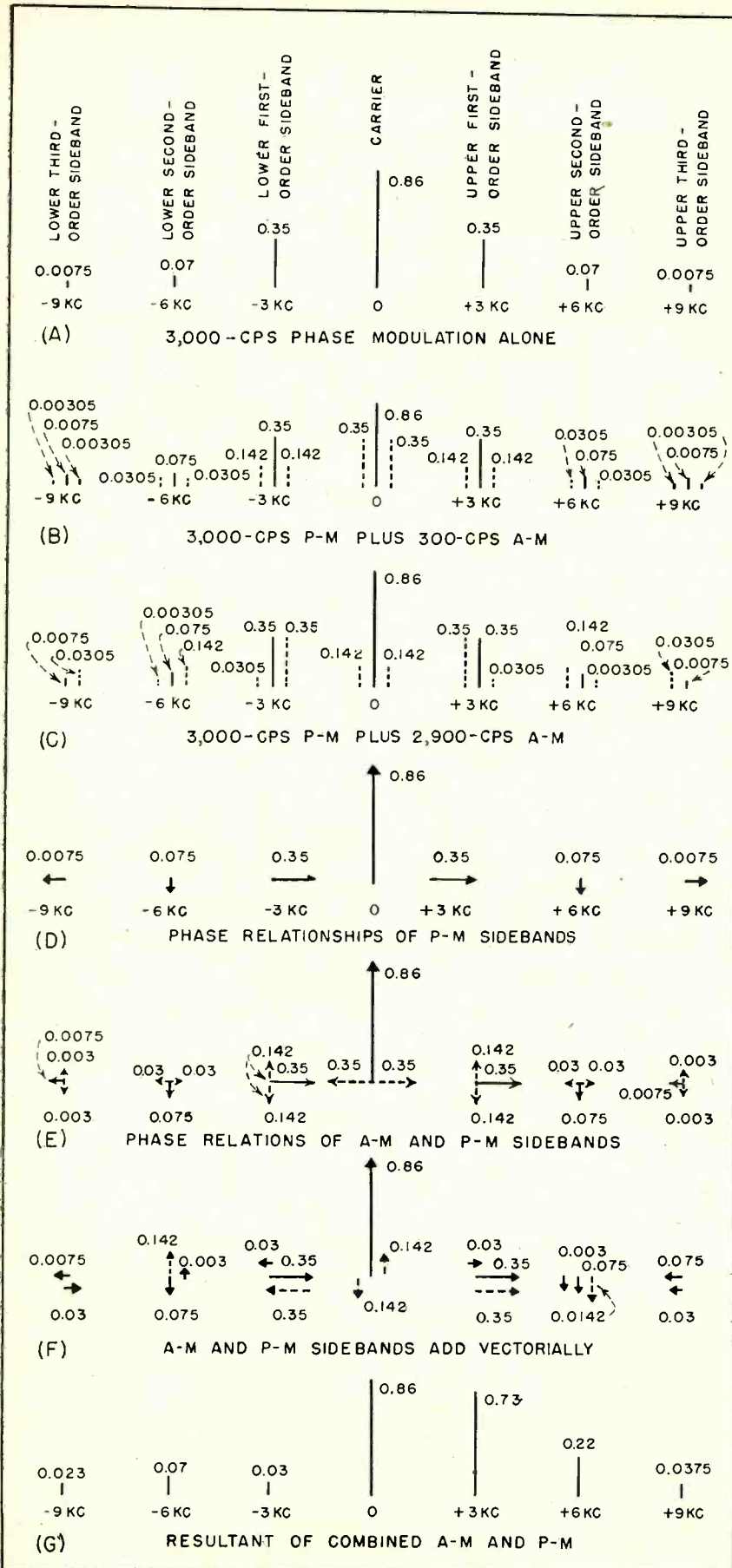

FIG. 2—Type of transmitted signal produced by composite modulation can be visualized from the sidebands produced by it. Signals shown are not to scale

conventional way with a signal containing approximately 45-percent second-harmonic distortion. In estimating the practical effect of this interference, it should be remembered that the strongest and most often-occurring frequency components in speech or music are in the range below 1,500 cycles, where the sidebands fall within the assigned channel and negligible distortion occurs in reception.

Adjusting the Modulators

The combined modulation system has been tried both in the laboratory and in several experimental transmitters. Its installation involves one unusual feature, which is a phase-equalizing network. The purpose of this network is to make the frequency response of the phase modulator, and of any associated amplifiers, identical to that of the amplitude modulator and its associated amplifiers. This is essential if the 90-degree phase shift existing at the output terminals of the phase-shift network is to be preserved through to the voltages which actually perform the phase and the amplitude modulation. Any difference between the shapes of the frequency response curves of the two modulator channels will introduce a spurious phase shift which must be avoided. In most cases it will be found that the frequency response of the amplitude modulator is worse than that of the phase modulator, owing to the presence in the former of driver and modulation transformers.

The required equalization can then be obtained by inserting simple single-section R-C high-pass and low-pass filters in the audio line to the phase modulator. It is convenient to make the resistances variable and to find the correct values experimentally with the aid of an oscilloscope connected to show the phase shift between the voltages actually performing the phase and the amplitude modulation. The leads normally connected to the two outputs of the 90-degree phase-shift network are connected in parallel and to the terminals of an audio oscillator. If the 45-degree line on the oscilloscope opens into an ellipse at any frequency, undesired phase shift is present. The

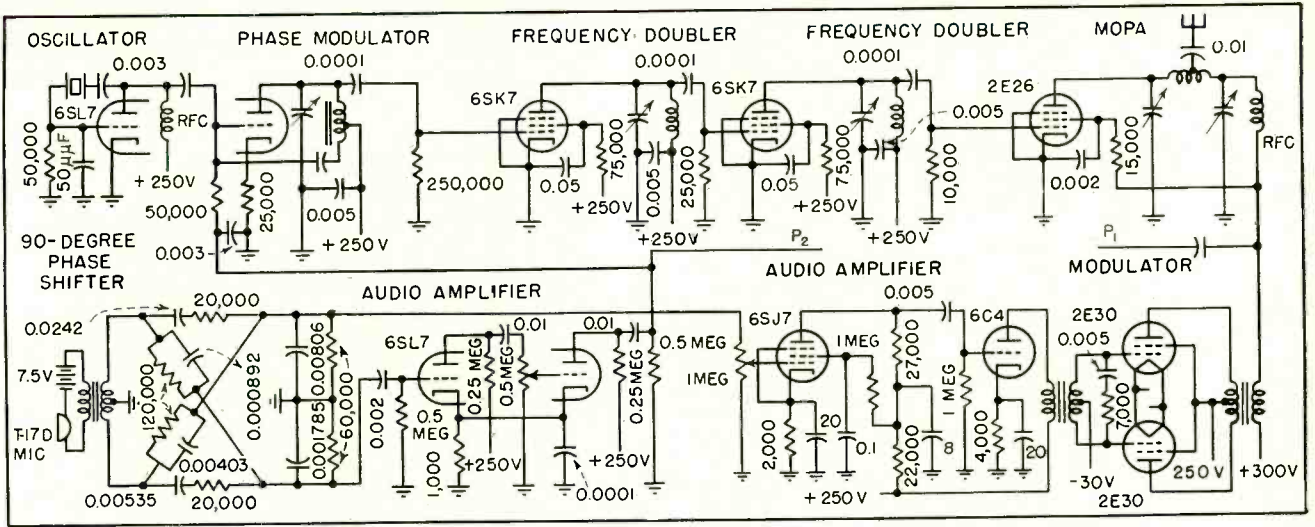

FIG. 3—Principal circuits of mobile transmitter using composite modulation. Values of unlabeled parts depend on carrier frequency

correct adjustment of the equalizing network is surprisingly easy to find in practice, even when widely different phase and amplitude modulators are used. It is theoretically possible that filters having two or more sections with differing time constants might be needed if the amplitude modulator has many stages compared with the phase modulator. In the cases tried so far, single-section filters have been sufficient.

The phase modulation index for optimum sideband cancellation is readily found with the aid of a selective receiver, preferably one having a crystal filter. A sine wave in the 2,000- to 3,000-cycle range is applied to the amplitude modulator, and the percent modulation adjusted to 81.5. The receiver is then tuned to the unwanted sideband and the gain of the phase modulator adjusted until cancellation occurs.

Note that only *one* adjustment (relative phase modulator gain) is required. There is no simultaneous radio-frequency phase setting to be made, nor are there any balanced modulators whose characteristics must be equalized, as in other phase-rotation single-sideband systems.

Cancellation of the undesired sideband with the composite system is readily detectable in practice, even with a fairly unselective receiver. Receiving operators are seldom aware of the nature of the incoming signal, since it sounds like any other; they automatically tune slightly to one side of the incoming

carrier to make the modulation sound the loudest. Reversal of the phase of the voltage fed to one modulator will cause the opposite sideband to be cancelled; the receiving operator then finds he must tune to the opposite side of the carrier for loudest modulation. Another interesting demonstration is to ask the receiving operator to narrow his bandwidth and tune in the composite signal for best reception. If the phase modulator is then disabled, the receiving operator will report a noticeable drop in the strength of the modulation.

Circuit Details

To illustrate the stability and reliability of the composite system, the author installed a mobile single-sideband transmitter in the trunk compartment of his car. After 4,000 miles of vacation driving, some of it over unpaved roads in national parks, the transmitter was checked and found to be in perfect adjustment, having given satisfactory performance throughout the trip.

A simplified circuit diagram of this transmitter is shown in Fig. 3, and a photograph of the installation appears at the beginning of this article. The 90-degree audio phase shift is obtained from a network driven directly by a surplus T-17D carbon microphone. This microphone also serves very conveniently as a band-pass filter, its output being restricted to those frequencies (300-3,000 cycles) for which the phase-shift network is

effective. The stepup transformer between the microphone and the network should not have too high a turns ratio; the conventional variety will not maintain a 180-degree phase shift between halves of the secondary at all frequencies, owing to the finite input impedance of the network. Small power-output transformers of the type designed to match push-pull tubes (20,000-ohms plate-to-plate) to a 200-ohm line have been found to be satisfactory.

The transmitter itself consists of a commercial phase-modulated unit which has been modified for simultaneous amplitude modulation. The final stage was rewired to permit simultaneous plate and screen modulation, and a smaller screen bypass capacitor inserted. No other changes were needed. The amplitude modulator is conventional. In this particular arrangement, the only phase equalization found to be necessary was the 0.002-μf capacitor in series with the line to the phase modulator audio input. This was determined by connecting an oscilloscope to the points marked P₁ and P₂ and following the procedure outlined earlier.

Research, the result of which is described in this paper, was an outgrowth of Project W-28-099-Ac-131 between Stanford University and the Watson Laboratories of the Air Materiel Command. The author wishes to thank the Watson Laboratories for their cooperation and for permission to publish this paper.

Regulator for

By **CARL A. HELBER**

*Jack and Heintz Precision Industries,
Bedford, Ohio*

NUMEROUS methods have been used for regulation of aircraft inverters. Among them are the carbon pile, Tirrill vibrating contact, Brown-Bovari, Silverstat and others. In each of these systems there are some moving parts which are subject to mechanical wear.

The electronic regulator to be described compares favorably with the previously mentioned regulators in regard to size, weight, accuracy, reliability and other factors. While the regulator which was developed for use on a 250 volt-ampere machine is somewhat heavier (1.7 lb compared to about 1.1 lb) than the carbon pile regulator, it has the advantage of having no moving parts.

In laboratory tests the unit appeared to be quite reliable for any of the conditions it was designed to meet. The electronic regulator is capable of providing about 40 watts of d-c power to the exciter field in the inverter and maintains the output voltage of the inverter within ± 1.0 volt from no load to full load.

Inverter Operation

As shown in the diagram, the inverter is supplied with 28 volts d-c from the aircraft battery and generator. The exciter field current is supplied partly by the 28-volt d-c source to help the machine build up and partly by the rectified a-c from the output of the inverter. Without a-c excitation, the 28-volt supply provides about 30 volts at the output terminals of the inverter at no load.

The field current is governed by the saturable reactor *SR*. As the current through the d-c winding of *SR* is increased, the reactance de-

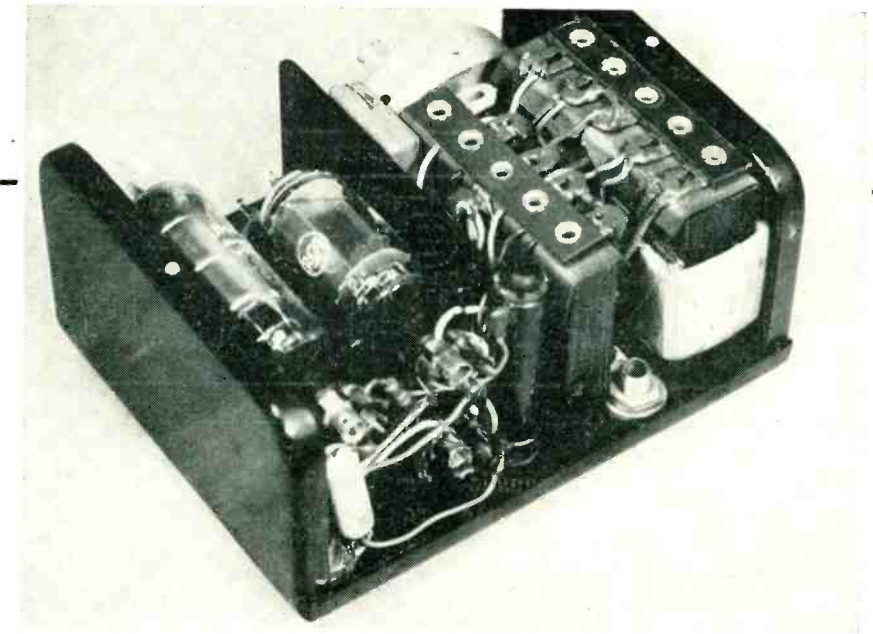

The entire regulator is packaged to fit into a space of $4\frac{1}{4}$ by $3\frac{1}{2}$ by 2 inches high

creases. This action increases the amount of excitation provided to the machine. By adjusting this current to the proper value, the output of the machine can be maintained within narrow limits for a wide range of load conditions.

Tube Circuit

Most voltage-sensitive circuits provide a rapidly increasing current with a small increase in voltage above some given reference level; this being just the opposite of the characteristic which is desired by the saturating coil of the reactor. It is therefore necessary to provide a fixed maximum current through the saturating coil of the reactor, this current being bucked by the current provided by the voltage-sensitive circuit. The fixed current is made high enough to provide full output from the reactor when the voltage reference circuit is not supplying any bucking current. The major portion of this current is bucked out by the voltage reference circuit under the condition of lowest field requirement (no load).

The voltage-sensitive circuit, 2D21 and OB2, is designed to provide a sharply increasing current

for a slight increase in output voltage. This characteristic is obtained by triggering a thyatron with the voltage drop across a resistor in series with a VR tube. The thyatron is normally a-c biased to a point sufficient to prevent firing. When the voltage drop across resistor R_1 is great enough to overcome the necessary portion of the bias, the thyatron will fire. With the circuit arrangement used, firing occurs at approximately the peak value of the output voltage and therefore the thyatron conducts for about one quarter of a cycle.

Because of the relatively high inductance of the polarizing winding on the saturable core reactor, the pulses of thyatron current are smoothed considerably. The number of these pulses provided to the polarizing coil per second determines the average current flowing in the polarizing coil of the saturable core reactor.

In typical operation, the number of pulses per second may range anywhere from one to four hundred. This current opposes the fixed current provided by resistor R_2 . Thus the polarizing coil current may have any average value between the maximum current as provided

400-Cycle Inverter

Voltage output of an aircraft inverter is maintained within plus or minus one volt from no load to full load by a two-tube electronic regulator having no moving parts. Operation remains substantially constant down to -55 centigrade

by the battery and a value of zero.

Resistors R_3 and R_4 are used to provide the a-c bias for the 2D21. For economy, resistor R_3 is a potentiometer which is used to adjust the level of the regulator voltage. It was found that the d-c voltage drop across the polarizing coil of the reactor was at times sufficient to fire the 2D21 before the bias had gained sufficient amplitude on the positive half cycle of the a-c voltage. In other words at the instant when the a-c voltage is zero going from the negative half cycle to the positive half cycle, the bias is also zero. Since the voltage drop across the polarizing winding may be about 10 volts, some 2D21's will fire at this potential.

Capacitor C_1 is used to shift the bias a few degrees ahead of the anode voltage in order that the d-c voltage across the polarizing coil will not fire the thyatron. It should be noted that with the constants in the circuit the VR tube fires on the positive half of every cycle.

The thyatron may or may not fire on the positive half of each cycle depending upon the magnitude of the peak voltage drop across R_1 . This feature makes the firing of the thyatron dependent upon the conduction characteristics of the VR tube rather than upon the striking characteristics.

Since the regulator works on the peaks of the voltage which it is regulating, it is important to maintain a fairly sinusoidal wave form for the output of the machine. Another specification for these machines requires that the waveform be quite good any way so that the regulator does not actually impose any additional hardship on the designer of the machine.

The current supplied to the exciter field ranges from about 70 ma at 105 volts for no load to 150 ma at 225 volts for an output of 250 volt-amperes at a power factor of 0.9 lagging.

The regulator is used on a 3-phase inverter which is designed to

provide 250 va of 3-phase power continuously with conservative ratings or 250 va of single-phase power from terminals *A* and *B* with the machine running just within ratings. Checks have been made on the operation of the regulator at -55 C and the results indicate that the difference in voltage between this temperature and room temperature is not more than about one volt. Compensation for the variation in exciter field resistance had to be made, however, because of the fact that the field resistance, which is about 1,400 ohms at room temperature, is about 900 ohms at -55 C. A thermistor shunted with the proper value of resistance provides compensation and results in a regulator which is quite satisfactory. Tests at full load were run for 500 hours followed by 150 hours of cycling tests during which the load was changed abruptly from full load to no load in 5-second intervals. The output voltage remained within ± 1.5 volts for this entire period. The regulator was still operating satisfactorily when the test was shut down.

It was found necessary to shock mount the regulator to obtain suitable life from the 2D21 thyatron. When mounted directly on an inverter running at 12,000 rpm, the thyatron would last for about 100 hours after which enough cathode material had been broken loose to make the tube characteristics change considerably. It was suspected that the high (200 cps and above) vibration frequencies were responsible for this problem. Regulators based on the same principle have been built for machines up to 2,500 volt-amperes capacity and undoubtedly could be made for much larger machines.

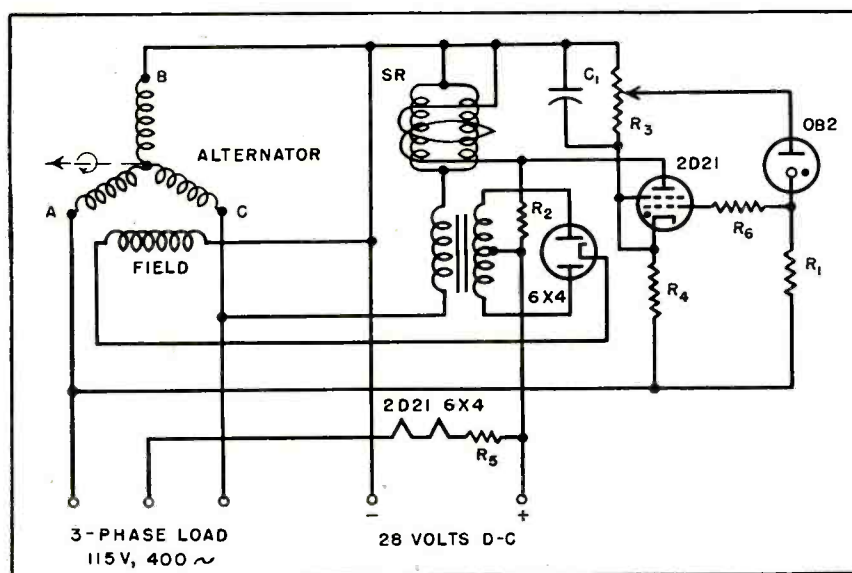

Complete circuit of voltage regulator for a 400-cycle, 250-volt aircraft inverter

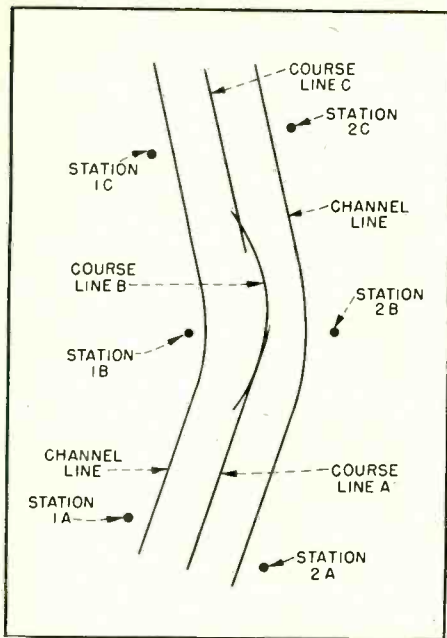

FIG. 1—Transmitter locations along a channel

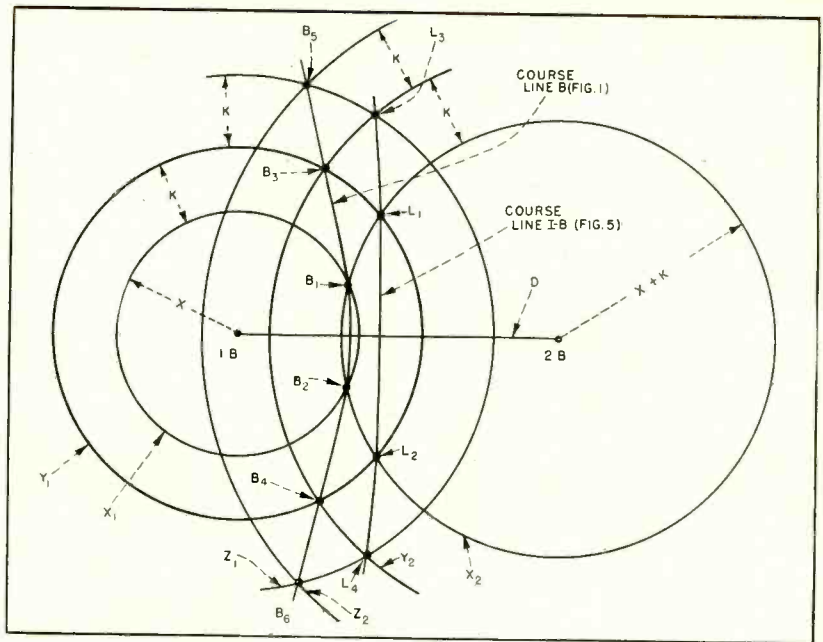

FIG. 2—Construction shows how straight and curved course lines are generated

Sonic Navigation

A new hyperbolic underwater-sound navigation system for harbors and channels uses pairs of transmitters pulsed at audible frequencies. A ship on course receives the two tones simultaneously. Aural monitoring assures position within 50 yards while lesser deviations are possible when meter indications are used

CONVENTIONAL METHODS of harbor navigation require the following of floating buoys in order to keep ships in the proper traffic lanes as well as in channels of safe navigable depth. Pilotage by buoys becomes extremely difficult in fog when neither the buoy nor the light with which it may be equipped is visible for any appreciable distance. Whistling and bell buoys can be followed at best only at a slow rate of speed and then only if all other conditions are quiet. As a result most ships are still forced to wait out a fog rather than risk entering or leaving a fog-bound harbor.

The Hysonav system described below employs underwater sound to mark channels and traffic lanes which can be followed by any vessel having only the simplest listening

equipment, independent of weather conditions.

System Elements

The system consists of one or more pairs of underwater sound generators located at spaced positions along a channel or traffic lane, one member of the pair (illustrated) on each side of the channel. In each pair the members are pulsed at intervals, and the pulse from each member has a distinguishing frequency characteristic. A person on a vessel sailing between a pair is in a position to hear both generators with a simple listening or hydrophone arrangement. Pulse lengths as short as 30 milliseconds are used, so that the listener can ascertain his position within fifty yards.

In accordance with the basic con-

cepts of a hyperbolic system, the listener navigates the path on which he receives a single note, indicating that first-arrival signals from both generators are being received simultaneously. This path is made to be a straight line or a curve, depending on channel shape and other harbor requirements. Where it is a straight line, two generators are pulsed simultaneously, so that the locus of points where the first arrival pulses are available simultaneously is a straight line which is the perpendicular bisector of the line between the generators. To provide a curved path, the two generators are pulsed in sequence, and, as explained below, the isotime locus generated is a hyperbola, which is made to fit a particular channel by adjusting the time interval between

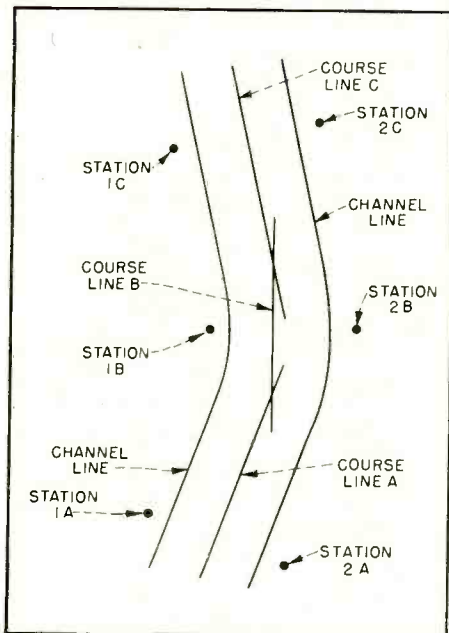

FIG. 3—Curved channel—straight courses

System

By **STANLEY R. RICH**

Design Coordinator

and

A. H. ROSEN

Patent Attorney

*Submarine Signal Co.
Boston, Mass.*

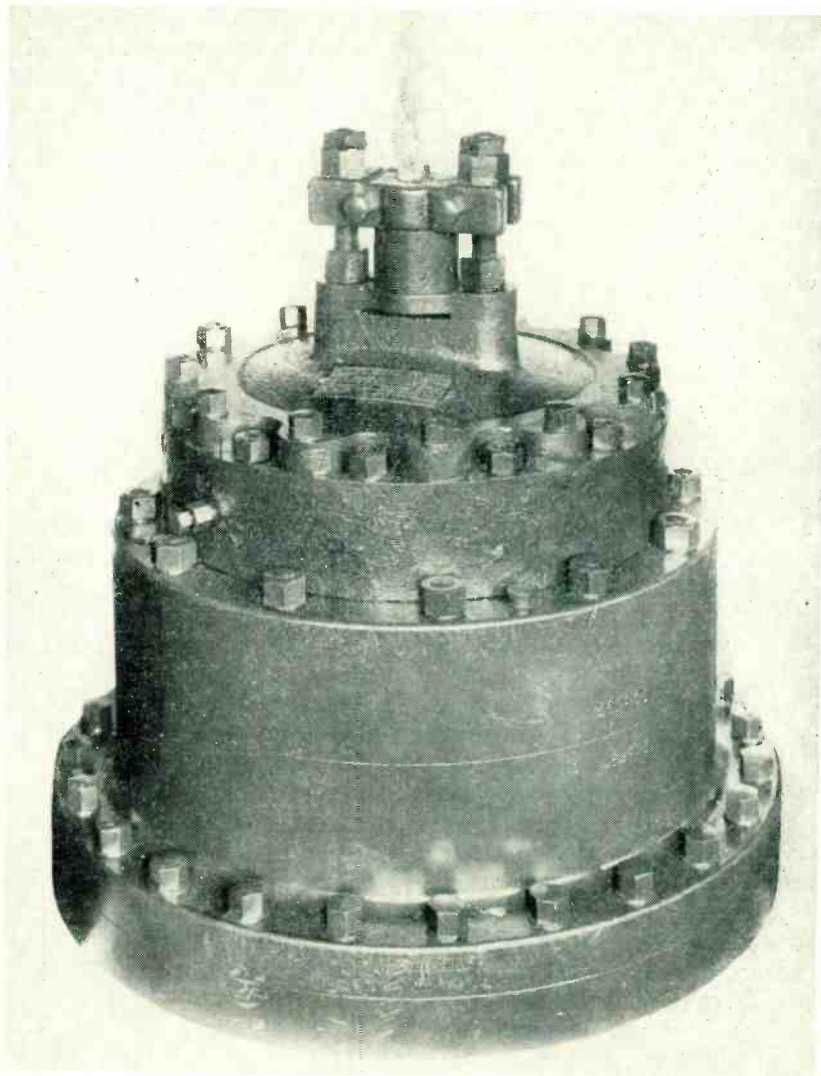

Oscillator transducer used at transmitter stations

the pulses. If the navigator is not on the predetermined path or course, he will hear first one and then the other pulse, and he tells them apart by the difference in audible pitch. In this way he knows which way to turn to regain his course. This information may be used to enable the navigator to keep to one side of a predetermined center line for two-way traffic.

Referring to Fig. 1, a ship channel is illustrated, as delineated by a pair of channel lines. It is desired to provide a system that will guide a vessel along the center line of this channel. A number of pairs of sound generators are located along the channel, the members of each pair being located one on each side. Thus Stations 1A and 2A comprise one pair, 1B and 2B a second pair,

and 1C and 2C are a third pair. Stations 1A and 2A are on a straight section of the channel. They are pulsed simultaneously at intervals which, for convenience, are regular. The stations of a pair are distinguished by a difference in the pitch of the respective signals; that is, the frequency of sound emitted by Station 1A is different from that of Station 2A. For example, 1A may oscillate at 600 cycles per second when pulsed, while 2A may oscillate at 900 cycles per second. The stations are so located with respect to the channel that the perpendicular bisector of the straight line drawn between them coincides to a satisfactory degree with the center line of the channel in the region of these stations.

This perpendicular bisector is

designed as course line A. It is the locus of points which are equidistant from both stations for sound travelling through the water, so that a person on a vessel which is navigated along this line is in a position to hear a single sound, which is a mixture of 600 and 900 cycles per second, whenever the stations are simultaneously pulsed. Thus, a navigator who is provided with only simple underwater listening equipment needs merely to steer the path along which he hears this single mixed signal to remain in the channel and on course line A in even the deepest fog. If he steers or drifts too far to one side or the other, he will hear a sequence of two pulse signals, either a low and then a higher frequency, or vice versa, each time the two stations are

pulsed, and will know that he is closer to the station that emits the first frequency he hears. Navigators would, of course, be furnished with the necessary information from which they can mark the locations of the stations and the frequencies of their signals on a chart of the channel, so that one may know which way to turn to sail along course line A. The course line can be regarded as a highway center-line, and, when it is desired to navigate to either side, it is useful that the signals are received successively rather than simultaneously.

Curved Channels

After passing along course line A, the channel curves to the left, in the region of stations 1B and 2B. Stations 1B and 2B are pulsed in such a fashion that the locus of all points at which the emitted pulses will be heard simultaneously is a curved line which follows the curve in the channel to a satisfactory degree. This line is designated as course line B in Fig. 1. Course line B is curved by pulsing one station of the pair before the other. The direction of curvature is determined by the order of pulsing, and the degree of curvature by the amount of time difference between the pulsing of the first and second stations. In Fig. 1, course line B is curved to the left by pulsing station 2B prior to station 1B.

Station 1B emits signals having the same sound frequency as those of 1A, while 2B emits signals having the same sound frequency as those of 2A. As the navigator leaves Stations 1A and 2A behind and approaches 1B and 2B, the signals from the former fade and those from the latter become louder. Where the two paths cross, both pairs of stations will be heard, and a choice of paths may be presented to the navigator. Before he has gone far, the signals from Station A will become weak enough and those from Station B strong enough that there will be no doubt by which to be guided. The signal strengths of the pairs of stations are so adjusted that there is not a strong set of signals tending to guide the navigator out of the channel; that is, course line A fades out

in the listening equipment long before the navigator can be guided out of the channel, while course line B becomes comparatively so strong that he will make no other choice than to follow it. Also, the signals from the nearest pair will be heard first. From course line B the navigator proceeds to another straight course line C, which is produced by the third pair of stations 1C and 2C in the same fashion as course line A.

The signals that are heard by the navigator consist of first arrivals plus reverberation signals. The first arrivals are the signals by which the navigator is guided, the reverberations being ignored. Since the first arrival signals are much louder than the reverberations, that is not difficult. Also the pulse repetition frequency of the generators is made deliberately low (ten seconds between pulses). This per-

mits ample time for reverberations to die out prior to the successive pulsing of the generators. The pulsing of the various pairs of stations need have no definite interrelation, but as will be shown a sequence can be provided which further reduces the chances of confusion.

Timing the Pulses

Consideration of the problem of planning and laying out course lines in a channel in the system reveals that there are four ways in which a pair of sound generators may be treated that are of interest. These four cases are:

Case 1. They may be pulsed simultaneously, and the locus of points of simultaneous arrival is a straight line which is the perpendicular bisector of the line between them (course line A).

Case 2. They may be pulsed in

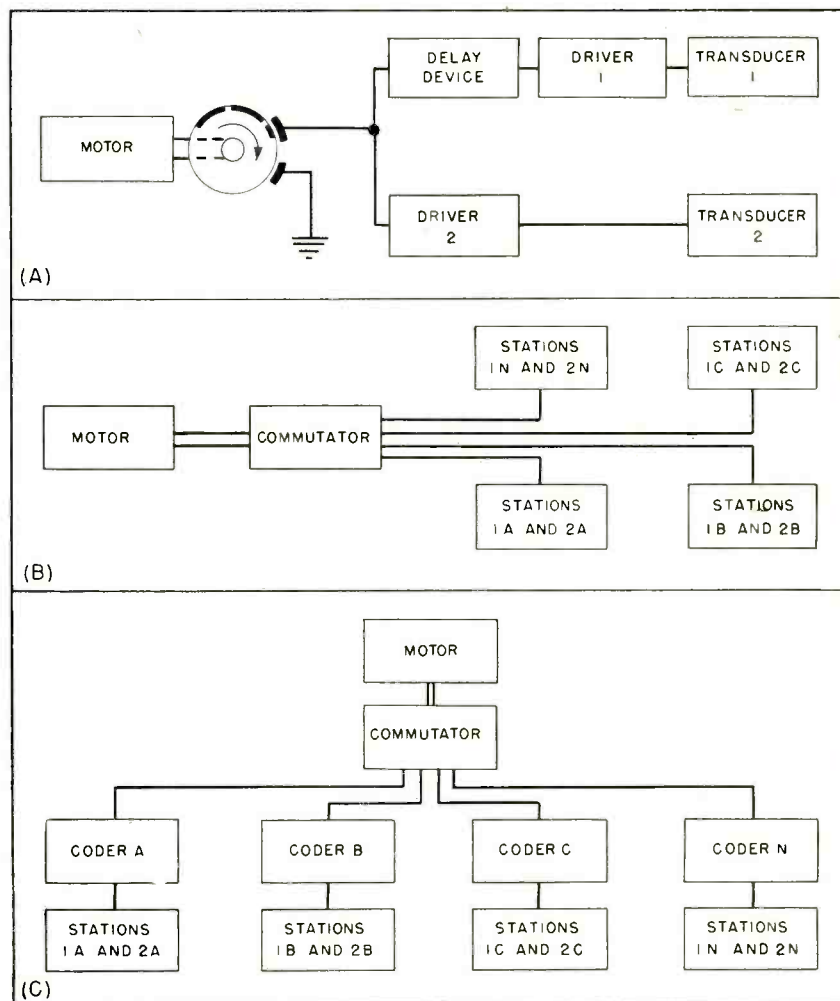

FIG. 4—Development of keying and coding methods from simple motor-driven commutator. Delay device shown in A is used to generate curved-channel signals

sequence, and the locus of points of simultaneous arrival is that line of which each point is X lineal units from the second station pulsed and $X + K$ lineal units from the first station pulsed, where K is a constant equal to ct , c being the speed of sound in water, and t the time difference between pulses in a given pair.

Case 3. They may be pulsed simultaneously, and the locus of points of fixed differential time (t') of arrival is that line in which each point is T seconds from the first station heard, and $T + t'$ seconds from the second station heard. Here T is analogous to X above, and $T + t'$ is analogous to $X + K$.

Case 4. They may be pulsed in sequence and the locus of points of fixed differential time (t') of arrival is that line in which each point is T seconds from one of the stations, and $T + t + t'$ seconds from the other station, where both t' and t are constants. Again T is analogous to X and $T + t + t'$ is analogous to $X + K$.

Referring now to Fig. 2, Stations 1B and 2B are shown with a straight line D drawn between them. The actual shape of course line B depends not only on X and $X + K$ as developed above, but also on the length of D , which is apparent from Fig. 2. If we assume that Station 2B is pulsed before Station 1B, then in accordance with Case 2 above, the locus of points of simultaneous arrival of the first arrival signals from both stations is that line which is everywhere X lineal units from Station 1B and $X + K$ lineal units from Station 2B. This locus can be determined as shown in Fig. 2, using one of the standard methods by which hyperbolas are constructed in elementary descriptive geometry. The distance D being fixed, the amount of curvature of the hyperbola drawn is governed by the value of the constant K , which is to say, by the fixed amount of time delay between pulsing of the two generators 1B and 2B, since c is the same for sound from both stations. It will be recognized that the constant K represents an identical elapsed time in the travel of both signals to the observer. It will likewise be appre-

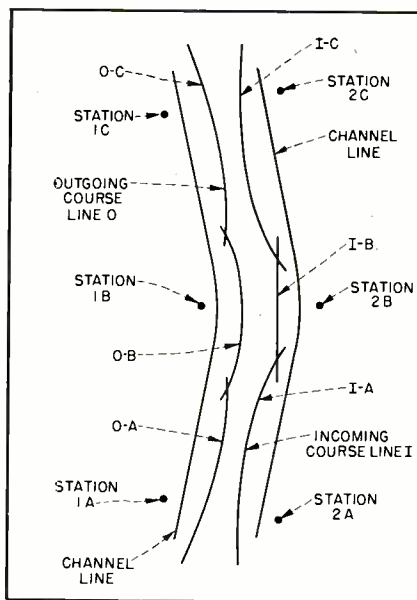

FIG. 5—Incoming and outgoing channels can be indicated by observing time differences

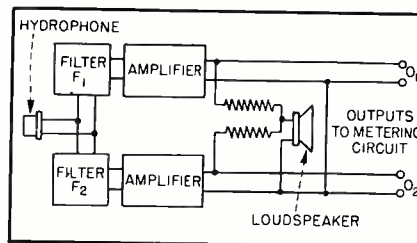

FIG. 6—Time difference indicator

ciated that the foregoing discussion applies equally well to Cases 3 and 4 mentioned above, being understood that K includes also the fixed differential time of arrival.

When the bend in a channel is slight, it is not always necessary to curve the course line to fit, but, depending on the width of the channel, the conditions to either side of it, and the traffic problem, it may often be satisfactory merely to employ a series of straight course lines having different respective directions. Such an arrangement is that of Fig. 3, which is otherwise the same as that of Fig. 1.

Receiving Equipment

As stated, a vessel need be equipped with only the simplest kind of listening apparatus in order to take some advantage of the system. Such an apparatus might comprise a hydrophone connected to a suitable amplifier, which furnishes output signals to a loudspeaker. The hy-

drophone is omnidirectional in construction and installation. An even simpler arrangement, a stethoscope-like listening arrangement known as a sea tube can be employed. Or, in a more elaborate electronic equipment the two pulses can be separately amplified and compared, as in the arrangement shown in Fig. 6. The hydrophone then feeds into two filters in parallel, each of which passes only the frequency of one of the stations. One filter is set for f_1 (600 cps) and the other filter is set for f_2 (900 cps). Each filter feeds into an amplifier which provides two separate output signals at O_1 and O_2 , respectively. The loudspeaker is provided with the output of both amplifiers simultaneously by a bridging or isolating circuit arrangement. The output signals have sufficiently high level for use in an automatic electronic time comparison circuit. Such a circuit is shown in Fig. 7.

Keying the Transmitters

The signal generating equipment is composed of conventional parts, as in Fig. 4A. A keying device or coder controls the output of two transducers, one for each station of a pair. The coder generally comprises a pair of switch contacts and a motor-driven commutator. The commutator has a group of switch segments each of which is successively closed. One segment, in this instance, is of a given length, and the other two are longer so that when the commutator is rotated in the direction indicated by the arrow, the code letter W is generated. The coder keys two drivers, one for each of the two transducers, respectively. The keying signal to one of the drivers is fed through a device that serves to delay the output from one transducer with respect to that from the other transducer. Thus, if these transducers are the sound producers for Stations 1B and 2B of Fig. 1 respectively, the system of Fig. 4A can be set up to emit, for each keying operation of the coder, a pulse from Station 2B and thereafter a pulse from Station 1B, the time between these pulses being controlled by the delay device. The delay device can be omitted where a straight path (Stations A or C) is desired, or placed in the line to the

other driver if the curvature of the path is to be reversed.

The possibility of confusion when the navigator is transferring his observations from one pair of stations to the next pair along his path has already been noted. The arrangements shown in Fig. 4 are provided to eliminate such confusion completely, and are particularly valuable in crowded harbors or in channels where the region to either side is dangerous. To enable a navigator to distinguish between sets of stations, the various pairs may be provided with characteristic codes. Thus, the A stations may be pulsed with a dash, while the B stations may be pulsed with two dots, and the C stations with a dot and a dash.

Confusion between adjacent pairs of stations can be minimized also with the system shown in Fig. 4B. There each of the pairs of stations is brought to a commutator switch driven by a motor. The switch functions in the usual manner to key the pairs of stations in succession, one pair at a time. Keying is maintained at a low repetition rate so that a navigator will not hear the signals of two pairs of stations together. This arrangement also permits reverberations to die out between the keying of adjacent stations. The arrangement of Fig. 4B also enables a navigator to pick out the signals of the next pair of stations that he is going to use before he begins actually to use them.

In Fig. 4C the coding arrangement of 4A is incorporated into the system of 4B by placing individual coders in the lines between the commutator and the pairs of stations, thereby keying the respective pairs of stations through their own individual coders.

Multichannel Navigation

Now, by arbitrarily choosing two sets of particular fixed time differences and orders of arrival for each pair of stations, two separate marked paths can be provided for incoming and outgoing traffic. Figure 5 illustrates how an incoming course line I and an outgoing course line O are provided in the same channel, so that two-way traffic can be handled. The incoming course line I is made up of sec-

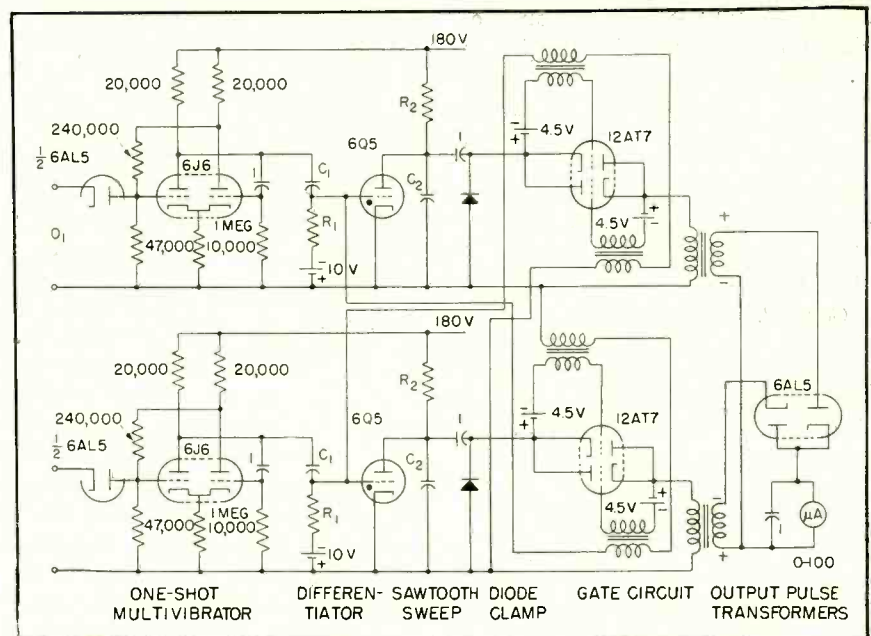

FIG. 7—Circuit diagram of metering circuit used with time difference indicator

tion I-A for stations 1A and 2A, section I-B for Stations 1B and 2B, and section I-C for Stations 1C and 2C. Similarly, the outgoing course line is made up of sections O-C, O-B, and O-A. Each section of each course line has a predetermined fixed time difference and order of arrival for the pulses from its pair of stations.

Where the channel is straight or nearly so, the stations of a pair are pulsed simultaneously, as in Case 3. Such stations are the A stations and the C stations. A navigator negotiating the incoming course line I is then in a position to hear the No. 2 member of each of these pairs first, while on the outgoing course line O he will be in a position to hear the No. 1 member first. Where the channel curves to an appreciable degree, the two B stations are pulsed in sequence (as in Fig. 1). Then Case 4 applies, and the navigator on the incoming course line negotiates a path that is nearer to the No. 2 station than to the No. 1 station; even nearer than is the corresponding course section B in Fig. 1. As a result, the signal from Station 2B not only starts first, but also arrives first. Referring again to Fig. 2, it is recalled that circles X_1 and X_2 exist simultaneously, while Y_1 and Y_2 exist simultaneously, and the same is true of Z_1 and Z_2 . However, if the navigator is to occupy a position such

that the wavefront represented by circle X_2 passes him first, and then, a fixed time later the wavefront represented by circle Y_1 passes, which is the condition when he negotiates incoming course section I-B, then the line that determines section I-B is the locus of points L_1, L_2, L_3 and L_4 , which has considerably less curvature than line B. This is to be expected, for the curvature that is imparted to line B by starting the pulse from 2B prior to 1B and receiving them simultaneously is changed in Fig. 5 by receiving the pulse from 2B prior to the pulse from 1B. For the same reasons, the outgoing course section O-B has a more pronounced curvature than line B in Fig. 1, for here the pulse from 2B is not only started earlier than the 1B pulse, but it is also received later. From the navigator's point of view, the effect is the same as on the straight stretches of the channel; on the incoming course the Station 2B pulse arrives first, and on the outgoing course the 1B pulse arrives first.

Thus the navigator may regard the course line in Fig. 1 as the center-line of a highway, and by keeping the pulses of one pitch coming in before the pulses of another pitch, he keeps to the right of the center line. From his charts, he can determine exactly what the time difference should be for each pair

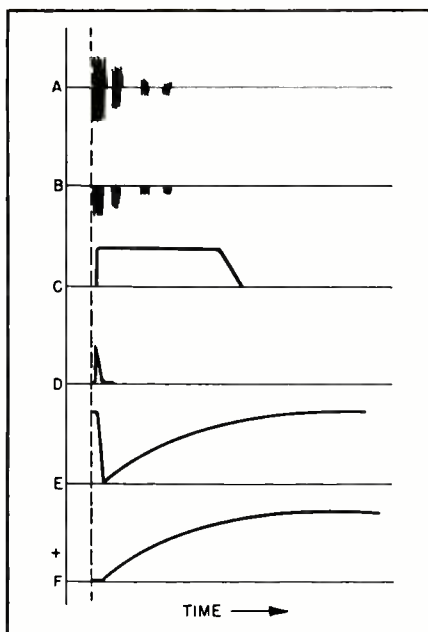

FIG. 8—Waveform oscillograms in time difference circuit

of stations to keep himself in the best path to the right of center. The time differences that he must observe for each line for each pair of stations will be furnished to the navigator in advance as part of his instructions for conduct while entering and leaving the harbor. He may employ the arrangement shown in Fig. 6 for determining that he is on a proper course line section. Such an arrangement is particularly valuable in that it tends to reject extraneous noise signals, such as propeller noises from other ships. With this apparatus, the ear alone can be depended upon to recognize and maintain a small time difference between two signals of a pair of stations, making possible safe navigation with very simple listening apparatus. For accurate measurement of the time difference, however, the navigator can employ the indicator shown in Fig. 7.

This time difference indicator employs two identical channels, one connected to output O_1 and the other to output O_2 of Fig. 6, in each of which there is generated a single voltage pulse trigger in response to the first arrival signal from the corresponding station of the pair under observation. Each pulse trigger initiates a sawtooth voltage wave in its own channel and controls a normally open gate stage in the other channel. The output of the

sawtooth voltage stage of each channel is momentarily made available, through the gate circuit of that channel, to a meter into which both channels feed, and which indicates the amount and sense of the time difference. Since both signal channels are identical, only one need be described.

Channel Indicator Circuit

Each signal channel includes a one-shot multivibrator, a differentiating circuit, a sawtooth sweep generator, a gate circuit, and an output pulse transformer. The multivibrator is set up so that the first triode is normally conducting in the absence of signals. A diode is provided in the input circuit of the one-shot multivibrator and connected so that negative voltages only appear on the control grid of the normally conducting triode in response to signals from the station under observation. As shown in Fig. 8, at A, the signal from a station consists of a first arrival wave train of comparatively large amplitude, plus reverberations. The negative portion of this signal, shown at B, appears on the grid of the triode. This signal initiates the action of the one-shot multivibrator whose time constants are set up to be long enough to prevent reversal until all reverberations and other signals have disappeared. The differentiating circuit has a time constant C_1R_1 of the order of 1 millisecond, and produces a short positive pulse across R_1 , marking the leading edge of the multivibrator reversal (C). This pulse is shown at D.

The sweep generator is an RC circuit (R_2C_2) triggered by a thyatron. The control grid of the thyatron is triggered by the differentiating circuit R_1C_1 . Thus, a semisawtooth voltage wave is provided as shown at E. The sawtooth voltage wave is sampled by a gate circuit.

A diode clamp is connected across the output of the sweep generator on the isolated side of the channel. The sweep voltage that is available to the gate circuit is shown at F. This sweep voltage starts at the zero level because of the diode clamp.

The gate circuit is a conventional back-to-back triode gate. Each sec-

tion is biased to cutoff, as shown, and is provided with a grid-input-control pulse transformer. The O_1 channel gate is connected to the differentiating circuit of the O_2 channel, and the O_2 channel gate is connected to the differentiating circuit of the O_1 channel. Thus the O_1 channel gate is controlled by the positive pulse from the O_2 channel, and the O_2 channel gate is controlled by the O_1 channel.

The secondary windings of the output pulse transformers of the O_1 and O_2 channels respectively are connected to a normally centered meter which is deflected to one side or the other depending on the magnitude and direction of the output signal. The two secondary windings are so phased that their output signals deflect the meter needle in opposite directions, and each is connected to the meter through a suitable rectifier.

If the two first arrival signals from a pair of stations are picked up in sequence, one is fed through O_1 to one channel, while the other is fed through O_2 to the other channel. The pulse trigger (Fig. 8D) which corresponds to the first signal opens the gate in the second channel, but since the second channel has not yet received any signal, there is no sweep voltage to be sampled through the opened gate. This same pulse, however, starts the sawtooth wave in its own signal channel. Thereafter, the trigger pulse from the second channel opens the gate in the first channel and a pulse having a peak voltage determined by the instantaneous level of the sawtooth voltage in the first channel is applied to the output circuit. Thus, the sampled output of only one of the sweeps is applied to the meter, namely, that which comes from the signal channel carrying the first signal received, and the voltage level at which it is applied is determined by the time difference between the two signals. If the two signals are received simultaneously, both trigger pulses occur simultaneously and the meter will not deflect. The loudspeaker will at all times furnish the information that the signals are being received, so that an operator need refer to the meter only at intervals to secure an accurate measurement of the time difference.

Low-Distortion

By PAUL W. KLIPSCH

*Klipsch and Associates
Hope, Arkansas*

TRANSFORMERS are recognizable as sources of distortion due to the nonlinearity of the inductance, which gives rise to an exciting current that contains components other than the fundamental. The same nonlinearity also produces intermodulation distortion.

The crossover network can be used to reduce transformer distortion by placing at least part of the low-pass filter between the power source and the low-frequency output transformer, instead of between the output transformer and the load.

Consider an output transformer operating between a high-impedance tube source and a 5,000-ohm load (referred to the primary side). Assume the primary inductance to be 26 henrys. At 30 cycles $\omega = 190$ and $\omega L = 5,000$. The shunt reactive load, equal to the resistive load, would produce a response which is 3 db down at 30 cycles. This is considered good response.

Next consider that the exciting current contains a considerable harmonic content. At ordinary power levels the third harmonic would typically be about one-third the amount of the fundamental current. This harmonic current, flowing in the generator impedance, produces a distortion voltage which is then fed to some other load, such as a high-frequency channel.

Evidently, a much higher primary inductance is required for reasonable distortion than would be required merely to give a flat response.

The circuit of Fig. 1A is an approximate equivalent of a tube source G_1 having a tube impedance R_p , feeding a transformer having a winding resistance R_T and primary inductance L . The distortion components are considered as being produced by generator G_2 . This added generator produces harmonic voltages and intermodulation products.

The crossover network arrangement of Fig. 1B accomplishes two major purposes. First, the low-pass filter $L_1 - C_1$ attenuates high frequencies propagating in either direction. Voltages produced by G_2 are attenuated before reaching tube impedance R_p , so that relatively less distortion voltage is available at R_p for transmission to the high-pass channel.

Second, $L_1 - C_1$ attenuates high frequencies from G_1 propagating to the transformer, so that a narrow range of frequencies is received by T_1 . The modulation products generated in T_1 (represented by G_2) are therefore of lower order than would be the case if the transformer were required to handle the entire spectrum. Furthermore, such modulation products from G_2

are again attenuated in their transmission back to the impedance of the tubes.

Obviously, both these effects reduce the distortion which can be fed to the high-frequency channel. The most annoying distortion generally appears as a form of high-frequency noise, and reduction of transmission of low-channel distortion to the high channel reduces this form of distortion.

This network system, by limiting the distortion produced by the nonlinear exciting current of the low-frequency output transformer and by limiting the transmission of such distortion back into the rest of the system, offers a double-dose cure for over-all distortion.

The network of Fig. 2 has already been described in some detail.¹ This circuit was originally developed primarily for purposes of economy. Since the original publication, some of the reasons for the superior performance have been studied, with the result that the advantage of lower distortion is now recognized as of greater importance than the reduced cost.

Numerical Example

For the conventional tube output circuit one may set up transformer requirements. Taking the exciting current as composed of a fundamental component $I_1 = E/\omega L$ and a third harmonic content $I_3 = (1/3) I_1$, consider a tube source with R_p of 2,000 ohms working into a load of 5,000 ohms, and consider a low-end cutoff of 31 cycles. Assume we want to limit third harmonic distortion to 0.5 percent or 0.005 per-unit of the fundamental.

The inductance can be determined from

$$L = R_p / 3\omega_1 D \quad (1)$$

where L is the primary inductance of the transformer, R_p is the plate

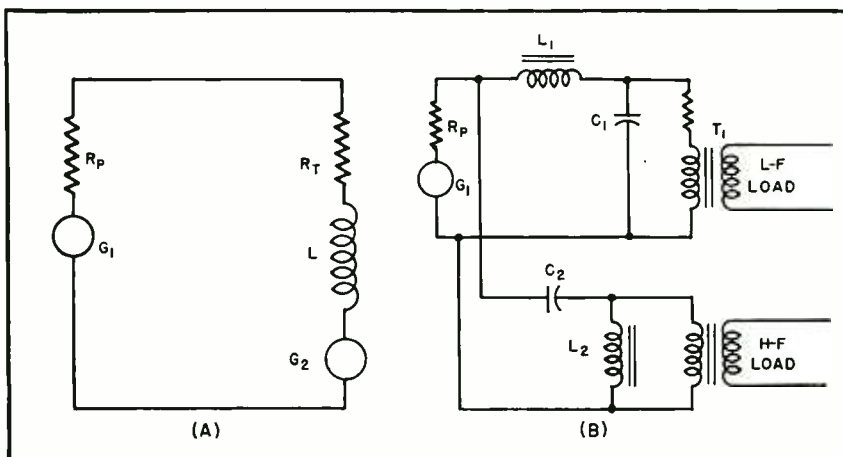

FIG. 1—Equivalent circuit of output tube, and recommended crossover network arrangement for reducing distortion due to inductance of output transformer

Crossover Network

If placed between the output stage and the low-frequency output transformer, an audio crossover network for woofer-tweeter loudspeakers reduces distortion due to nonlinearity of transformer inductance and makes special transformer designs unnecessary

impedance, ω , is the angular velocity of the lowest frequency, and D is the per-unit distortion. (Distortion D is the product of the harmonic component of exciting current times the tube impedance, divided by the fundamental voltage. The exciting current (fundamental) was $I_1 = E/\omega_1 L$. I_3 is taken as $I_1/3$, so $I_3 = E/3\omega_1 L$. $I_3 R_p = DE$ so $D = 1/3\omega_1 L$ or $L = 1/3\omega_1 D$.)

Putting in numerical values, $L = 2,000/3 \times 200 \times 0.005 = 667$ henrys. This is a difficult value to achieve, doubly so if the leakage inductance is to be held to a minimum dictated by a top limit of transmission of say 15,000 cycles.

If the transformer is required to transmit only the lower part of the total spectrum the leakage inductance limitation is removed and a transformer with realizable ratio of primary-to-leakage inductance can be designed. Therefore, placing the low-pass filter ahead of the transformer relaxes its design requirements relative to maximum primary-to-leakage inductance ratio.

Placing the filter ahead of the transformer also reduces the required primary inductance for a stipulated distortion. First, the filter attenuates in each direction, so that harmonics and other distortion products arising in the transformer are attenuated before getting back to the generator where they can be transmitted to the high channel. Second, the higher frequencies are attenuated in a forward direction so that the distortion products arising in the transformer are of low order.

Thus, conventional transformers with primary inductance values of the order of 100 to 200 henrys can be used, instead of special designs with values like 667 henrys. Further, since the transformer is re-

quired to transmit only up to the crossover frequency, say 500 cycles, the leakage inductance is not a severe design requirement and the transformer may be a relatively low-priced unit.

Appendix

An examination of Eq. 1 and its derivation indicates the desirability of keeping the plate impedance low. Triodes, with or without feedback, and the more efficient beam tubes with voltage feedback, both offer the desirable low impedance. Either can be designed for any desired characteristics. It should be noted, however, that reducing the driver stage impedance to zero would still leave the transformer winding resistance, so a loudspeaker would never look back into zero impedance.

In the numerical example, the figures chosen would apply either to a pair of 2A3 (6B4G) tubes in push-pull without feedback, or to a pair of 6L6 tubes with about 15 db of voltage feedback.

To reduce the plate impedance to zero or near zero values might appear to be highly desirable. However, the characteristics of the driven loudspeakers are such that some source impedance is desirable. Even in highly developed horn loudspeakers, the efficiency and impedance vary, and the source impedance tends to smooth out the resulting response. In the case of direct radiators with the 20 to 1 variations in impedance a constant-voltage source is not the best.

Thus, feedback to reduce output impedance would appear capable of being carried too far. Feedback for distortion reduction can be applied simultaneously as voltage feedback which tends to reduce the tube impedance (make it constant voltage) and current feedback which tends to increase the impedance (make

the source constant current). A happy combination of the two might prove to be the best overall.

Here one is faced with the desirability of an optimum impedance for operation of the loudspeakers, and a minimum impedance from the standpoint of distortion in the transformers. The crossover arrangement discussed here offers the possibility of minimizing transformer distortion while maintaining the tube impedance at optimum levels from the standpoint of loudspeaker operation and distortion.

Either voltage or current feedback reduces distortion in the tube system (and both together reduce distortion to the same extent as would the same amount of total feedback of either type by itself). A combination of both affords any desired impedance, so it appears that the designer is free to design the amplifier for optimum loudspeaker performance, relying on the described crossover to hold the distortion from reasonably good transformers within tolerable levels.

In the numerical example, a low cutoff of 31 cycles was chosen. There are very few loudspeakers that will reproduce a 30-cycle fundamental. If one is dealing with direct radiators of moderate size cutting off around 70 to 90 cycles, the improvements afforded by the present crossover will be but slightly noticeable. But if one starts working with organ reproduction or generation where low-C performance is demanded, some very annoying distortions crop up. It is particularly for the users of reproducers capable of 30-cycle performance² that this article is written.

REFERENCES

- (1) P. W. Klipsch, Crossover Network, *ELECTRONICS*, Nov. 1945.
- (2) P. W. Klipsch, Design of Compact Two-Horn Loudspeaker, *ELECTRONICS*, Feb. 1946.

Light-Flash Generator

Flash repetition rate may be continuously varied between 12 per minute and 150 per second. Flash duration is continuously variable from 400 microseconds to 2 seconds. Either of two light sources may be made to precede the other

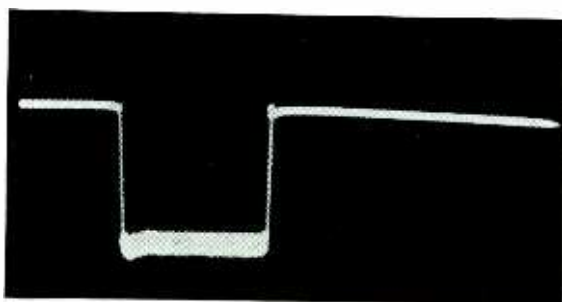

FIG. 1—Waveform of 400-microsecond light flash

By **R. G. ROUSH**

*Electronic Design Engineer,
Systems Research
The Johns Hopkins University*

and **FERDINAND HAMBURGER, Jr.**

*Professor of Electrical Engineering
The Johns Hopkins University
Baltimore, Maryland*

IN MANY FIELDS of visual research, a convenient method of generating controllable light flashes is desired. For example, studies of flicker can be greatly simplified if a system is available for the production of a repetitive light flash which can be varied in duty cycle without changing its rate of presentation.

The problem of producing such a flash by mechanical means is a difficult one if flexibility of adjustment is required. To overcome many of the problems associated with a system of this nature, an electronic flash system has been developed and is described in detail in this paper.

General Description

The equipment was designed to permit presentation of one or two light-flash sources. These light-flash sources may be presented at repetition rates continuously variable from one flash in five seconds to 150 flashes per second. The duration of each flash is continuously variable from a minimum value of 400 microseconds to a maximum of 90 percent of the period of presentation, or about 2 seconds. Either of the two flash sources may be delayed in time of presentation with respect

to the other from a minimum value of 1 millisecond to a maximum of two seconds, the maximum available delay time being limited at all times to the difference between the period of repetition and the duration of the flash.

The light flashes are produced by exciting a facsimile recording light source of the glow-modulator type, such as the Sylvania R1131, with a voltage of rectangular waveform and of the desired duration. The tubes are of the hollow-cathode or crater type which produce a high ionization density when excited. They are designed in such a manner that this discharge is viewed in depth, thus giving a resultant flash of high intensity having spectral characteristics determined mainly by the type of gas employed and the ionizing current. In this application, the tubes are operated so that a considerable portion of the output energy lies in the visible spectrum.

Examination of the flash under dynamic conditions has indicated that there is no apparent shift in spectral characteristics during the flash period. Measurements were made by viewing the flash with a spectrally selective photometer¹ and

examining the electrical output of the photometer on the screen of a cathode-ray tube. A typical waveform obtained by this method is shown in Fig. 1. The minimum pulse length of 400 microseconds was purposely chosen to illustrate the rapid build up and decay time of the flash.

Basic Operation

To demonstrate the basic operation of the individual timing circuits a functional block diagram of the equipment is given in Fig. 2. The voltage waveforms appearing at various points in this diagram are represented by Roman numerals. The numbers also appear frequently throughout the paper and refer to the correspondingly numbered waveforms given on the timing chart in Fig. 3.

The repetition-rate multivibrator shown in the functional block diagram provides an adjustable-frequency square wave (waveform I) from which a reference timing-trig-

This work was carried out in the Electrical Engineering Laboratories of The Johns Hopkins University under Task Order No. 1 of Contract N5-ori-166 between Special Devices Center, Office of Naval Research, and The Johns Hopkins University.

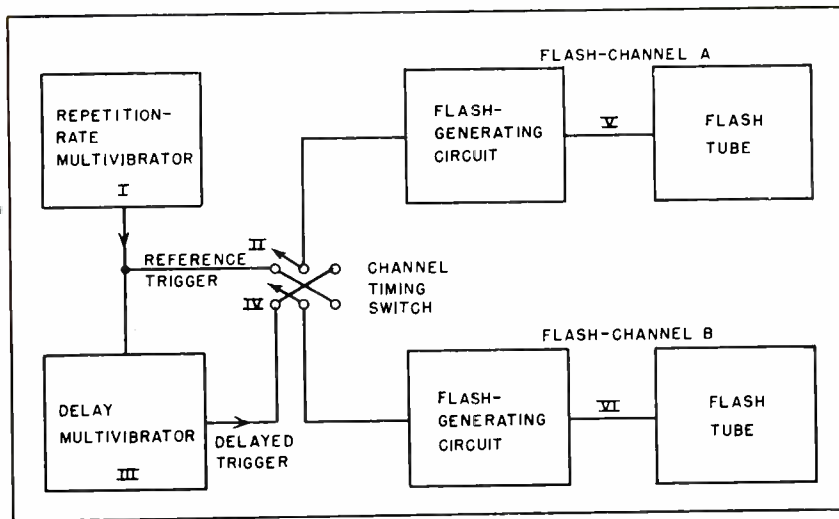

FIG. 2—Functional block diagram of light-flash generator

ger pulse (waveform II) is obtained for the system. This voltage is connected to the upper left terminal of the reversing switch labeled Channel Timing Switch and also is applied to the delay multivibrator as shown. In the latter circuit the reference trigger is delayed to provide a second timing pulse waveform IV similar in every respect to the timing trigger pulse but occurring at a subsequent time, t_d . The delayed trigger is connected to the lower left terminal of the channel timing switch and the output terminals of the switch are connected to the flash-generating circuits in the manner shown in the diagram.

Each of the flash-generator circuits consists of a single-cycle square-wave generator which is cycled by the timing trigger appearing on its input line. The output voltage of each of these circuits is developed across the flash tube in sufficient amplitude to permit the desired light intensity level to be realized. Since the flashes in each channel are initiated by the trigger pulses connected to their respective inputs, it can be seen that when the channel timing switch is in the left-hand position, the flash in channel A (waveform V) is cycled by the reference trigger (waveform II) and thus occurs at t_r . The flash in channel B is initiated by the delayed trigger and therefore occurs at t_d . When the switch is in the right-hand position the flashes are reversed in order of presentation

(channel A has waveform VI), thereby providing an extremely useful device for temporal discrimination studies.

Reference And Triggers

The circuits of the reference and delayed-trigger sources are shown schematically in Fig. 4.

The period of the reference trigger is established by a cathode-coupled free-running multivibrator, V_{11} , whose period is determined by the R-C time-constant of its grid circuit. Coarse adjustments of repetition rate can be made in five steps by means of the capacitor selector switch S_1 , and fine adjustments by means of the linear potentiometer R_5 . The value of R_1 was so chosen as to limit the ratio of maximum to minimum period on any range setting to a value of six. This value represents the approximate limit of the ratio for continuously adjustable periods without introducing amplitude distortion of the multivibrator output voltage.

The output of V_{11} (waveform I) is differentiated and negatively clipped by the combined action of C_0 , R_6 , R_7 , and the series-diode clipper V_{2A} . Additional clipping action is provided by the inverted diode V_{2B} , so that the absence of any negative voltage at the grid of V_{3A} is assured. The voltage appearing at the cathode of V_{2B} is therefore a positive trigger (waveform II) which serves as a reference timing voltage for the system. The synchronizing

trigger voltage is applied to the single-cycle delay multivibrator, V_3 . The components of this circuit were selected so that V_{3B} is normally conducting and V_{3A} normally cut off. When the synchronizing trigger arrives at the grid of V_{3A} these conditions are abruptly reversed by the combined action of the feedback paths supplied by R_0 and the selected capacitor in the bank controlled by S_2 . Tube V_{3A} is therefore conducting and V_{3B} cut off, a condition which is maintained until the grid potential of V_{3B} rises above the cutoff level. When this occurs, the conditions are again abruptly reversed, thus returning the circuit to its original state.

During the operating cycle, the current through the common cathode resistor R_0 is less than the normal quiescent current, since the tubes V_{3A} and V_{3B} are operated with different circuit components and under different bias conditions. The voltage appearing at the cathode of V_3 (waveform III) is therefore a negative square wave with leading edge coincident with the reference trigger (t_r) and trailing edge occurring at t_d , the time $t_d - t_r$ being established by the multivibrator cycle duration. In order that this delay time be realized in useful form, the square wave is differentiated and negatively clipped by C_{13} , R_{13} , R_{14} , and V_4 , thereby creating a second positive trigger (waveform IV) delayed with respect to the reference trigger. Variations in the multivibrator cycle duration thereby produce corresponding variations in the time spacing of the two synchronizing triggers. Since this time is determined by the exponential decay of the grid potential

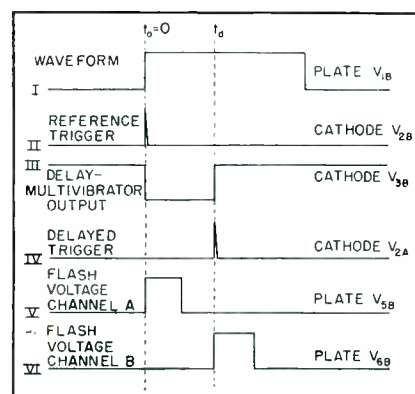

FIG. 3—Waveforms at various circuit points

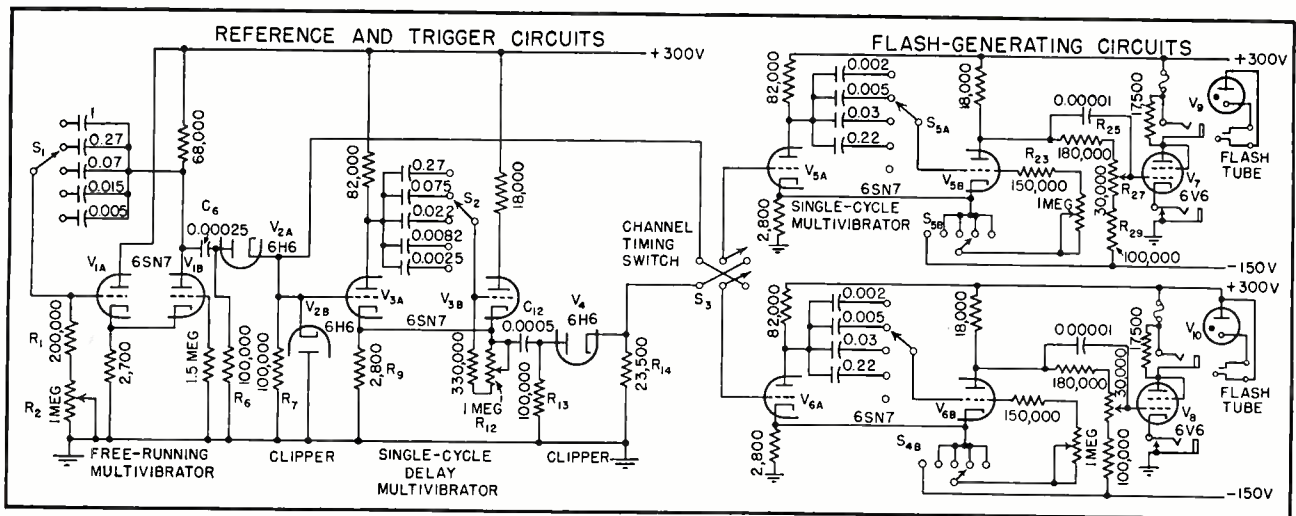

FIG. 4—Schematic of complete light-flash generator, less power supply

of V_{5B} , adjustments of the R-C time constant in this circuit produce direct variations of delay time. These adjustments can be made in five overlapping ranges by means of the capacitor selector switch S_2 and the linear potentiometer R_{12} , the combination providing continuous control of delay time in the available range.

Flash Circuits

The two trigger sources are connected to the two flash-generating circuits, included in Fig. 4, through the double-pole reversing switch S_3 . Since both channels operate identically in every respect, the circuit description to follow will be confined to channel I, the channel shown in the upper-right portion of the diagram. The twin triode V_{5a} , and its associated circuit elements constitute another single-cycle multivibrator whose operation is identical to that of the previously described delay multivibrator V_{3a} . The output of this circuit, however, is obtained from the plate of the normally-conducting tube V_{5B} . Cycling of the circuit by the application of a positive trigger of sufficient amplitude will therefore initiate a positive-going rectangular wave at the plate of this tube (waveform V), the duration of the cycle being dependent upon the R-C time-constant in the grid circuit of V_{5B} .

The output voltage of V_{5B} is applied to one terminal of a voltage-divider network composed of R_{25} , R_{27} , and R_{29} , the opposite end being returned to the negative 150-volt

supply. The variable tap on R_{27} is connected to the control grid of V_7 , a triode-connected beam-power tube whose plate load impedance consists of the glow-modulator flash tube, V_6 . Continuous excitation of this tube is prevented by adjusting R_{27} in such a manner that the grid bias on V_7 is well beyond that required for plate current cutoff during the quiescent period of V_6 . When the latter is cycled, the positive gate voltage appearing at the control grid of V_7 drives this tube into the region of conduction, thereby exciting the flash tube.

Coarse adjustment of flash duration can be made by means of S_5 and fine adjustments by R_{25} , the combination permitting continuous control of flash durations ranging from a minimum of 400 microseconds to a maximum of approximately 2 seconds. When S_5 is in switch-position 5, the gridleak resistor of V_{5B} is returned to the 150-volt negative supply, thus placing the flash-duration multivibrator in a continuous-cycle condition permitting adjustment of the flash-tube intensity to the desired level. The intensity level obtained by this method will be the value to which the flash tube will be excited under dynamic conditions, since the intensity is a function of tube current only.

Calibration

The timing calibrations were obtained through the use of an audio oscillator and a cathode-ray oscilloscope of the type permitting

beam-intensity modulation. The rectangular waveform to be calibrated is presented on the screen of the oscilloscope as a vertical deflection and the calibrating signal from the audio oscillator is superimposed upon this pattern as an intensity variation of the trace. To prevent drift of the intensity modulation of the trace across the pattern, the repetition frequency of the square wave must be a submultiple of the calibrating sine wave. This condition can be obtained by connecting the calibrating sine wave to the control grid of V_{1B} , thereby synchronizing the repetition-rate multivibrator with the timing signal.

By counting the number of spots present on the deflected portion of the trace, and multiplying this number by the period of the calibrating signal, the delay or duration time can be readily evaluated. The calibration of pulse lengths longer than 70 or 80 milliseconds by the above method becomes virtually impossible since the repetition rate of an 80-millisecond pulse must be less than $1/80 \times 10^{-3}$ or 12.5 pulses per second, at which frequency flicker effects are objectionable. For these and greater pulse durations a high-speed synchronous clock circuit² has been successfully used for calibration.

REFERENCES

- (1) Ferdinand Hamburger, Jr. and Ellwood J. King, A Recording Photometer and Its Use in Studies of Cathode Ray Screen Displays, *Jour. Opt. Soc. Amer.*, in press.
- (2) R. G. Roush and Ferdinand Hamburger, Jr., Electronic Chronograph for Measurement of Voice Reaction Time, *Amer. Jour. Psych.*, October 1946.

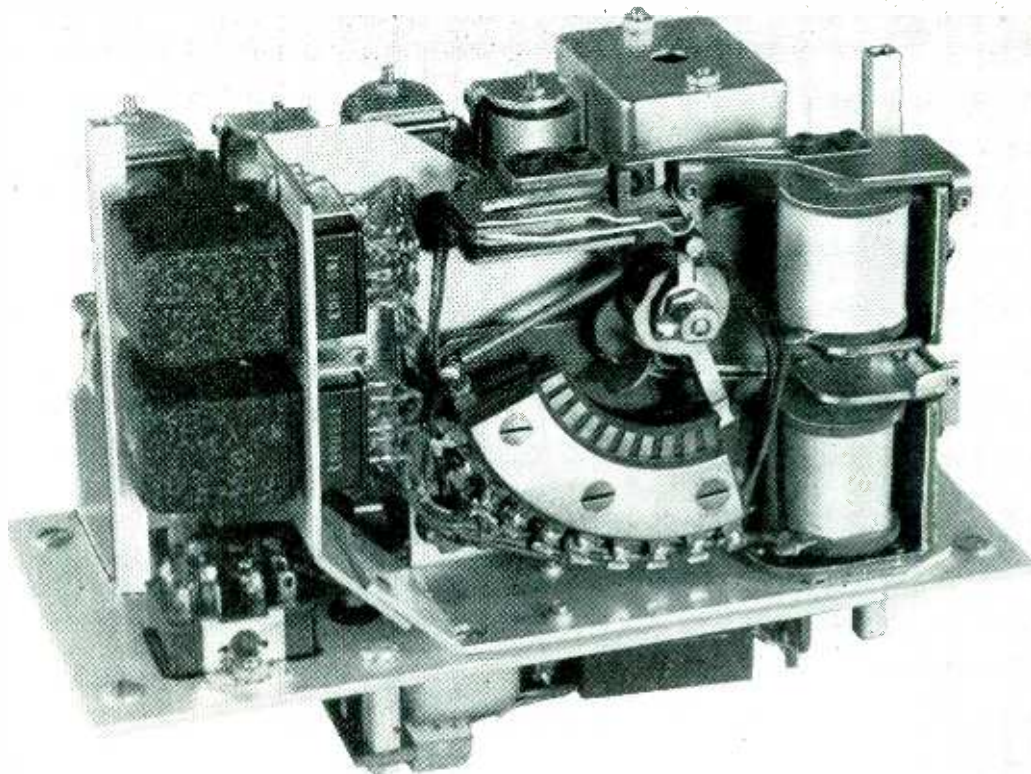

Stepping switch in center is controlled by incoming pulses and prewired connections of plugs at left. Audio peaking amplifier is on other side of partition. The whole unit can be plugged into a mobile receiver

Mobile Selective Calling

Mobile radiotelephone service for connection to wire telephone networks generally requires individual signal for each subscriber. A new low-cost decoder for dial-impulse selective calling can be used in areas now served by two-tone systems. A 2,600-cycle tone generator is added at the central office

MOBILE RADIOTELEPHONE systems used by police and similar services generally employ a loudspeaker in the mobile unit to monitor all transmissions. Thus the operator of the vehicle must listen to all the traffic in the system and be on the alert to answer whenever his name, number, or code is called.

While such an operation is satisfactory to some groups there are other miscellaneous users, among the general public, for whom the constant monitoring of the channel is unacceptable. They prefer a bell or other signal only when a call is specifically meant for their mobile unit and, in addition, often want a permanent signal such as a light,

By E. H. B. BARTELINK

*Radio Engineer
General Telephone Service Corp.
New York, N. Y.*

to appear when such a call has been received while they are absent from the vehicle. In such cases, a selective calling or signaling system is needed.

One type of service offered by the telephone companies provides connection to the wire network and enables the mobile user to communicate with anyone that he could ordinarily reach from a wire telephone. Selector systems for this general service, using the dual-tone principle, have already been developed and are in use. The new selec-

tive calling system described here was specifically designed to be low in cost yet usable in a general service system. It is, moreover, equally useful in other types of service requiring selective calling.

System Requirements

Two types of general service are presently being provided. One is the highway service, which is designed to cover arterial highways and surrounding territory; the other is the urban service for vehicles chiefly engaged in local operations. For the former service, which generally requires somewhat larger ranges, frequency assignments have been made in the 30 to

40-mc range, while the urban service has been assigned to the 152 to 162-mc band.

In the highway frequencies, it was found necessary to introduce a zoning plan of frequency assignments in order to avoid long-range interference. On the basis of the number of systems expected in each zone and the mobile units expected in each system, the present computations indicate that the number of mobile units, using the same channel or pair of frequencies in each zone, may be in the order of 1,500. To differentiate among all mobile units on the same pair of highway frequencies, a selector must be able to provide a corresponding number of different combinations.

An urban system, operating far removed from other cities, could be operated with a selector system which provides a number of combinations equal to the maximum number of mobile units that can be served by the system. According to present experience, this would require somewhere between 50 and 150 combinations, depending on the traffic conditions in the particular system. Wherever cities are located close together, so that cars frequently travel from the coverage of one mobile system into that of another, a much larger number of combinations is again necessary. Such conditions exist, for example, in the northeastern Atlantic coast region.

To give the subscriber satisfactory service, at least three conditions must be met. A comprehensive regional plan must be worked out by all the telephone companies involved so that the necessary coverage is obtained without causing excessive overlaps. Arrangements must be worked out by the telephone companies so that a customer of one telephone company will receive service no matter whether he travels in the coverage of a system operated by the company to which he is a subscriber or that of another company. Finally, sufficient uniformity in equipment must exist so that a customer can have uninterrupted access to the service as he travels through the service area of different mobile-radio systems. The first two requirements have been met by the cooperative efforts of

the different telephone companies confronted with these problems. Regarding the equipment, the standardization of the radio equipment is such that units made by different manufacturers can, in general, be used interchangeably provided that they are all adjusted to operate on the same channel.

In a local or urban system, far enough removed from other cities to minimize the chance of visits by outside units, any kind of selector system can be used provided it fits in with the general routine of traffic handling and does not require any other special treatment. For highway systems where the through customers already have dual-tone selectors and for urban systems adjacent to others using such selectors, it is still possible to use a different signaling system for the local customers provided the system meets the above requirements and that equipment at the central office can be arranged to signal to customers having either type of selector. Furthermore the additional provisions required at the central office should not result in any major cost differentials.

Fundamentals of Operation

The new selector system uses a single signaling tone in which the dial pulses that actuate the stepping mechanism of a multicontact switch are transmitted as interruptions of the tone. This tone is applied prior to the time that the operator starts dialing and is kept on for a short period after the dial-

ing is completed. The selector returns to the idle or starting position whenever the dial tone is interrupted for any period materially in excess of the dial pulse duration. Thus the selector is self-resetting and does not require any special clearing pulses to reset it to zero. Such clearing signals are needed in systems where noise might activate the selector and leave it set in some intermediate position.

The fundamental circuit of the receiver unit is shown in Fig. 1. In the idle positions, all relays except the release control relay, *RC*, and the release magnet, *RM*, are deenergized, and the off-normal contact, *ONC*, is in the position shown. The pulse relay, *P*, is operated by the rectified audio-frequency voltages appearing across a circuit tuned to the dialing frequency. If a steady dial tone is applied, *P* energizes and in turn operates the slow-release relay, *SR*, which deenergizes the release magnet, *RM*, prepares the circuit for the stepping magnet, *SM*, and thus readies the stepping switch for operation. Subsequent interruption of the dial tone will operate the stepping magnet and cause the switch to step under control of the dial pulses.

As soon as the switch arm has left the first contact, the off-normal contact, *ONC*, is operated. This removes one ground from the *RC* relay which, being of the slow-release type, is now held operated by the pulsations of the *P* relay contact. The *SR* relay is likewise held

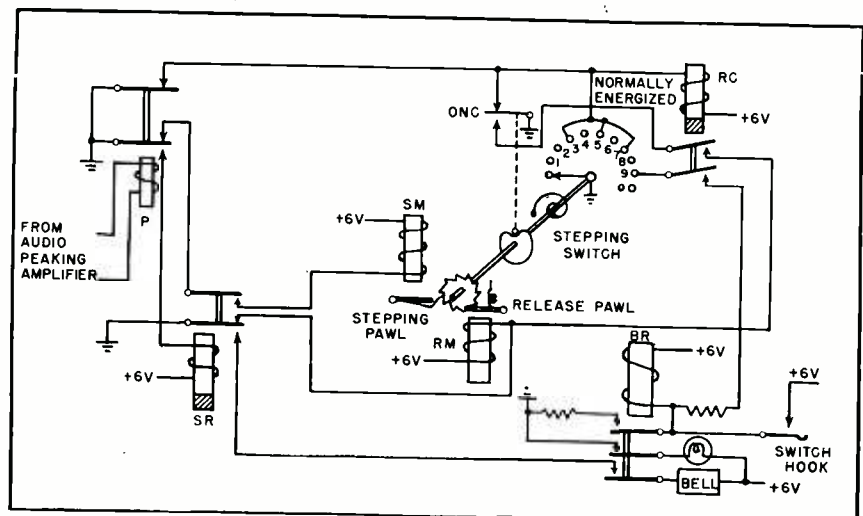
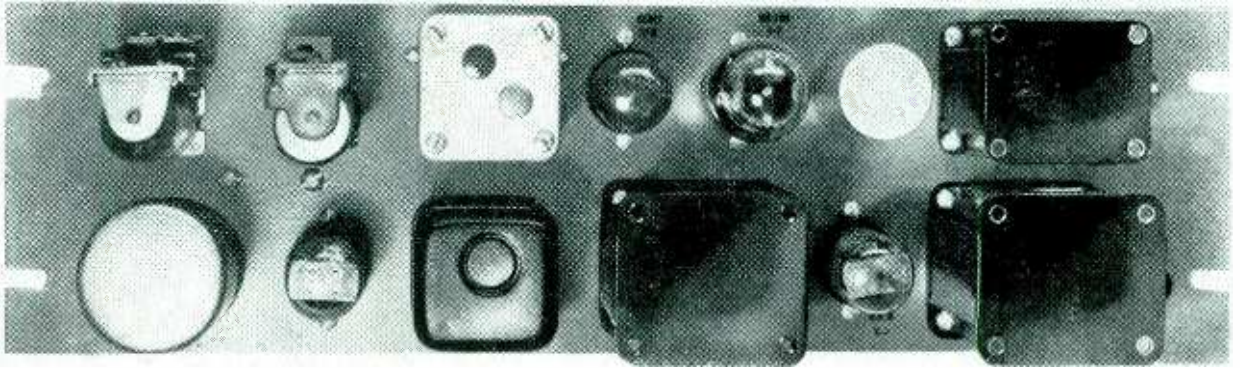

FIG. 1—Simplified schematic diagram of the decoder relay and stepping circuits



Tone generator and supervisory relays installed at central office

operated during these pulsations. At the end of a pulse series, the *RC* relay will release and, by operating the release magnet, return the selector to zero unless this pulse series left the switch on one of the specially selected contacts which are connected to the *RC* relay. If it comes to rest on one of these special contacts, the arm of the switch will provide ground for the *RC* relay which then remains energized. The release magnet is not energized; thus the switch will remain in this position and be ready to receive another series of pulses. The selection of these special switch contacts therefore determines the series of digits which must be dialed if the switch is to advance without setbacks.

The energizing circuit for the bell-ringing relay, *BR*, is connected to one of the latter contacts, for instance contacts 7, 8, or 9, on the switch; and the switch contacts beyond this point are left unconnected. If at the end of the last pulse series the switch comes to rest on one of these contacts, *RC* will release, as they are not connected, and thus cannot complete the circuit for *RC*. If the switch comes to rest on the contact to which *BR* is connected, *RC* will, when it releases, energize *BR*, which in turn will close a holding circuit through its own contacts. A very short time after this, *RM* pulls up and returns the switch to zero. Another contact on *BR* closes the circuit to the bell through a contact on *SR*. Thus the bell will ring until the *SR* relay is released by the interruption of the dial tone, which

occurs shortly after the completion of the dialing operation. Another contact on the *BR* relay energizes a signal lamp, which remains lighted until the subscriber removes his handset. This operates the hook-switch, and releases *BR* by shorting its winding.

In the actual selector, the *BR* relay is replaced by a decade-switching relay *DS* which is energized in the same way as the *BR* relay and which holds itself over a contact on the *SR* relay. This relay transfers the holding circuits which were connected between the *RC* relay and the special switch contacts to a second set of contacts on the switch. In the meantime, the switch has returned to zero and has energized *RC*. It is thus ready for a new series of impulses; and, if the proper code is again dialed, it will then operate the *BR* relay which is connected in the second set of contacts in the same manner as described before. It is this utilization of two sets or banks of contacts on the stepping switch which provides the much larger number of combinations.

In addition to providing a large number of different possible combinations (about 1,500), the new selector also permits group calling. If both the decade-switching relay and the *BR* relays are connected to contact 9, then the dialing of 99 will call all cars. If in some cars the *DS* relay is connected to contact 9 and in others to 8, and if the same holds for the *BR* relay, then the subscribers may be divided into four groups having group calling codes of 99, 98, 89, and 88 respec-

tively. Thus, for instance, the police department, the fire department, doctors, and the general public could be given group calls. If contact 7 is also similarly used, the number of possible group calls increases to seven.

Coding combinations are easily arranged by the insertion of two properly wired multicontact plugs into the mobile unit, one for each bank of contacts. This feature facilitates maintenance whenever all or part of the mobile equipment is removed from the vehicle. The code plugs are simply reinserted in a spare unit to give it the correct dial-response characteristics for the subscriber.

The decoder was built by Hammarlund Manufacturing Co., and was designed to be physically replaceable for the Fleet Control unit (described by J. K. Kulansky in *ELECTRONICS*, June 1946) for which provision has been made in several commercial models of mobile radio receiver chassis.

System Tie-In

Besides making provision for simple modification of existing Western Electric control units, without disturbing the original function, equipment has also been designed for central office use. A tone generator for 2,600 cycles and necessary relays for keying it in and out of service permit central-office signaling with either the new system or the existing two-tone system. A coded number assigned to the subscriber informs the operator which system she must use to complete the call.

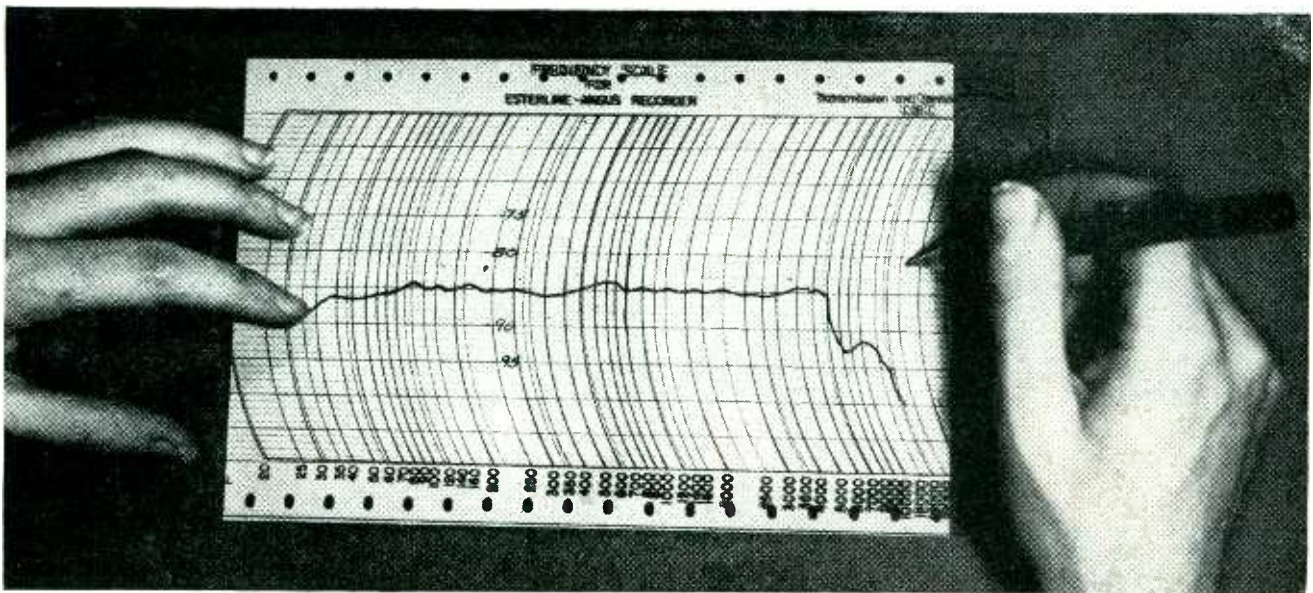

Transparent frequency scale is held over response curve produced on chart paper of recorder

Microphone Calibrator

By D. H. BASTIN

*Transmission & Development Department
Canadian Broadcasting Corporation
Montreal, Canada*

THE FIELD CALIBRATION of a microphone requires that the microphone be placed in a plane sound field of known intensity. This type of calibration differs from a pressure calibration in that the effect of diffraction around the microphone is charged up as part of the response of the microphone. It is therefore the most useful type of calibration for microphones used in broadcasting.

Inexpensive Dead Room

Obtaining the required sound field indoors is a matter of some difficulty because reflections build up standing waves to give a nonuniform sound field. The usual method of obtaining the sound field by the use of free-field or anechoic chambers was felt to be too expensive for the present project, so two less expensive devices are used to obtain the required field, one operating from 30 to 1,000 cycles and the

other unit operating from 1,000 to 15,000 cycles.

The two measuring techniques involved, outlined below, were developed for use on all microphones used in CBC studios across Canada. In both, the microphone being tested is compared against a standard microphone by a two-channel logarithmic voltmeter that automatically plots the response in decibels against frequency. The

system can also be used for recording loudspeaker response and polar diagrams.

Low-Frequency Chamber

The frequency response from 30 to 1,000 cycles is measured by placing the microphone three feet from the end of a wooden tube 30 feet long and 11 by 11 inches in cross section. A drawing of the tube is shown in Fig. 1. At the end of the

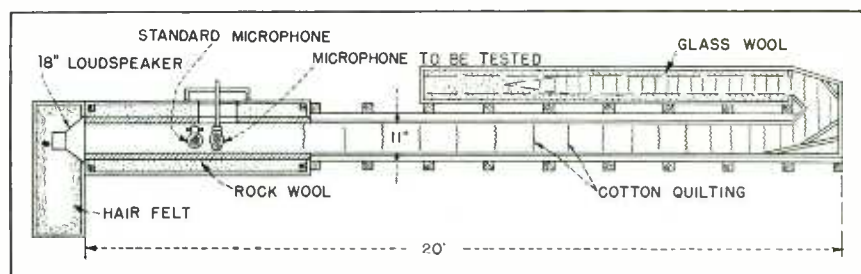
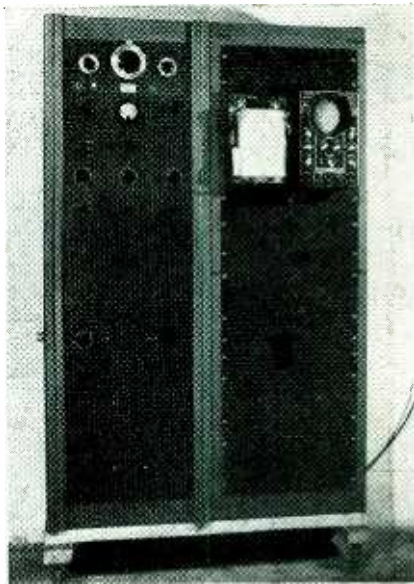

FIG. 1—Cross-section of 11-inch-square hollow wood tube used to absorb sound energy below 1,000 cycles from loudspeaker and thereby prevent reflection back to microphone being tested



Microphone calibration rack, designed to plug into a-c wall outlet

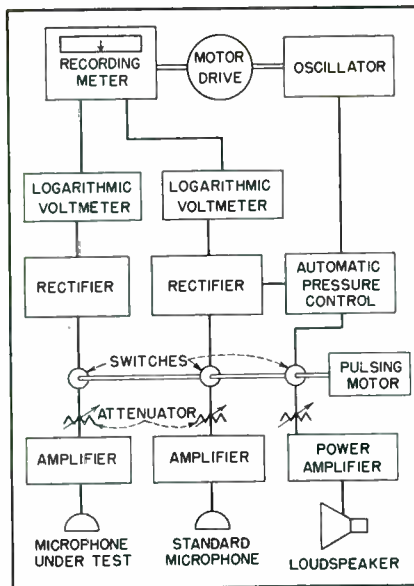

FIG. 2—Block diagram of microphone calibration rack used in CBC laboratories

nearest wall to arrive back at the microphone. The pulse is repeated at intervals long enough to allow reflections to die out between pulses. During the pulsing the frequency of the oscillator driving the loudspeaker is slowly changed and the response curve is automatically plotted by a logarithmic recording voltmeter. By rotating the microphone undergoing test a polar diagram of the response at any frequency can be plotted.

Pulse Length

The length of the pulse that is used is 10 milliseconds and the pulse is repeated 10 times every second. With a pulse of 10 milliseconds length and a sound velocity of 1,100 feet per second the sound path before the first reflection can reach the microphone is 11 feet. This means that the microphone can be half this distance or within $5\frac{1}{2}$ feet of the nearest wall, hence a comparatively small room is suitable for the measurement.

At 1,000 cycles a pulse of 10 milliseconds consists of only 10 cycles, of which the first and last few cycles are obscured by transients, so that 1,000 cycles is about the low-frequency limit of this pulsing system. In a larger room a longer pulse could be used, and consequently a lower frequency could be reached. On the microphone channels the beginning and end of the pulses are clipped to remove transients from the pulses before comparing the two signals.

No special treatment is required on the walls of the room used for this part of the test, for the repetition rate of 10 per second allows sufficient time between pulses for reflected sound to drop to a negligible value before the next pulse is transmitted.

The sound source used for the high-frequency test is a small dynamic loudspeaker that was found to have adequate output up to 15 kc. As will be noted later, the response of the source is not critical in this method.

Standard Microphone

The standard microphone is a small type M101 crystal unit $\frac{5}{8}$ by $\frac{15}{16}$ inch in size, manufactured by Massa Laboratories.¹ The pre-

Simple, rapid and reasonably accurate method of measuring sensitivity, frequency response and polar response without a costly free-field anechoic chamber. Below 1,000 cycles a long wood tube absorbs unwanted sound. Higher frequencies are pulsed and recording is done before reflected sound returns to microphone

tube near the microphone is a loudspeaker. That part of the tube on the far side of the microphone contains curtains of cotton quilting hung across the tube in increasing amounts to form an acoustic resistance to absorb the energy of the sound passing from the loudspeaker. The treatment is adjusted until the acoustic impedance looking into the tube is approximately that of open air, or 40 acoustic ohms per square centimeter.

With the source of sound located symmetrically on the axis of such a tube no standing waves exist across the tube for frequencies below 1,000 cycles, and the acoustic treatment effectively absorbs reflections from the end of the tube; the result is a plane wave flowing past the microphone. The tube can be used only below 1,000 cycles, because above this frequency standing waves exist across the tube.

Mounted beside the microphone

being tested is a small standard microphone, having flat response over the 30 to 1,000-cycle range, and of known sensitivity. The outputs of the two microphones are fed to the measuring rack and as the frequency of the loudspeaker signal is slowly changed the response curve is automatically plotted.

High-Frequency Pulse System

Over the range above 1,000 cycles a pulsing system is used to obtain effective free-field conditions. The microphone to be tested and a small loudspeaker are set up about three feet apart in a studio or small room. Midway between the microphone and loudspeaker is placed a small standard microphone.

A short pulse of sound at the desired frequency is transmitted from the loudspeaker, and the resulting output from the microphone is measured before enough time has elapsed for reflected sound from the

amplifier housing supports the standard microphone in the position for minimum diffraction effect, with the end of the crystal unit parallel to the sound axis. In this position the diffraction effect is negligible below 10 kc, and the response can be considered flat. A reciprocity calibration on this unit gave a value of sensitivity in good agreement with the value stated by the manufacturer.

The preamplifier housing contains a 9002 tube connected as a cathode follower, acting as an impedance changer between the high impedance of the crystal and the low-impedance output. Terminals are provided on the preamplifier for injecting a signal in series with the crystal for making overall electrical calibration of the associated equipment.

Tests have shown that at the testing distances used, 15 inches to the standard microphone and 30 inches to the other microphone, neither microphone has appreciable influence on the sound intensity at the other, and for the period of the pulse each microphone is in a progressive sound wave, the pressure at the nearer microphone being twice that at the other. In the low-frequency tube an inexpensive crystal microphone is used as the standard, and is checked at intervals against the Massa standard.

The absolute accuracy of the measurements depends upon the standard microphone, but the type of crystal microphone used appears to be stable, and a reciprocity calibration can be made upon it at any time if required.

Rack Equipment

Both parts of the calibration method require the comparison of the outputs of the two microphones. This comparison is carried out in the rack of equipment shown in the block diagram in Fig. 2.

The rack contains amplifiers for the two microphone channels, a logarithmic voltmeter which compares the outputs of the two microphones, a recording meter, an audio oscillator with a motor drive on the frequency dial, a power amplifier to drive a loudspeaker, an automatic pressure control, pulsing switches and a cathode-ray oscil-

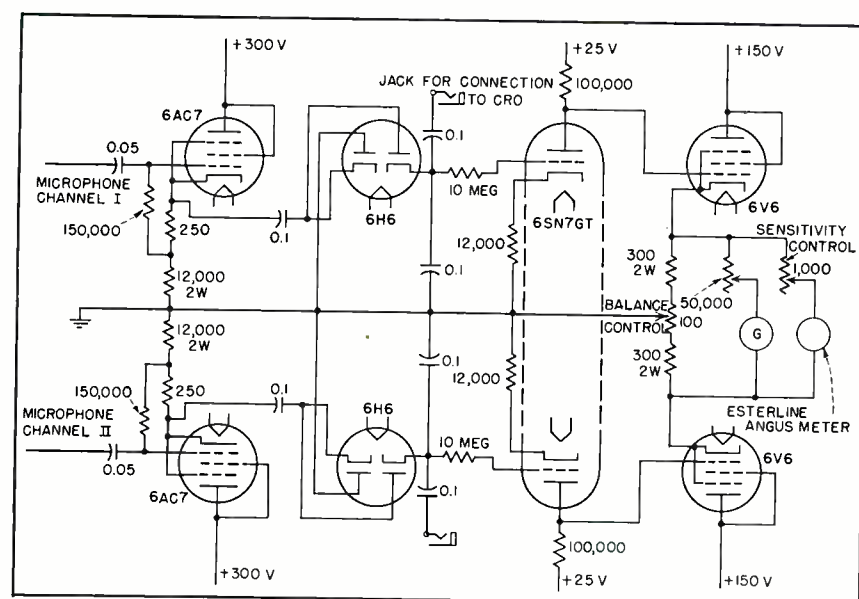

FIG. 3—Circuit of voltmeter providing logarithmic amplification over range of 46 db as required for plotting response curves in db

loscope for waveform examination.

The two microphone channels are similar, each consisting of an amplifier, attenuator, rectifier and logarithmic stage. The attenuator controls are marked directly in decibels on the front panel. Each amplifier is followed by a cathode follower, using a 6AC7 as shown in Fig. 3 to provide a low-impedance source and so avoid peak clipping by the rectifier action. The 6H6 rectifiers are connected as voltage doublers. The maximum undistorted signal available from the cathode follower is about 100 volts, hence the peak d-c output from the rectifier is about 200 volts, or 46 db above the minimum usable output of 1 volt. Below 1 volt the initial current from the diodes becomes important, introducing non-linearity.

Since only the amplitudes of the pulses are compared, the rectifier circuit has a short charge time constant, in order that the amplitude of the signal can rise to full value during the first millisecond of pulse. The discharge time constant is long, however, in order that the rectified level does not fall appreciably during the tenth second between pulses.

Logarithmic Action

Logarithmic action is obtained by applying the positive voltage from the rectifier through a 10-megohm resistor to the grid of a 6SN7GT triode section operating with 25

volts plate supply. Because the emission velocities of the electrons given off by a hot cathode follow a Maxwellian distribution, the grid current which flows bears a logarithmic relation to the applied voltage. This logarithmic change in grid current produces a corresponding change in grid-to-cathode voltage, which is amplified and appears as a change in plate potential. The circuit as developed by Walter Ives² is accurately logarithmic over about 46 db, the limitations lying not in the log tube but in the rectifier and amplifier ahead of the log tube.

The direct-current output of the two logarithmic stages is further amplified by direct-coupled 6V6 tubes connected as cathode followers and fed to the recording milliammeter, which is a standard 5-ma Esterline-Angus meter. A potentiometer at the midpoint of the cathode resistors of the 6V6 tubes enables the two channels to be balanced so that equal signals on the two channels give center-scale deflection of the meter. This meter responds to the difference between the output of the two channels, and so is equivalent to the difference of the logarithms of the two microphone signals, and hence to the ratio of the two microphone responses. Since the response of the standard microphone is known to be flat, the result is the response curve of the unknown microphone plotted in db

against frequency on the recording meter chart.

Recording Method

A sensitivity control in series with the meter can be set so that one division of the chart paper represents one db. The absolute sensitivity represented by the center line on the chart is found by subtracting the difference in gain of the two microphone channels, easily read off the two panel attenuators, from the sensitivity of the standard microphone. The two-channel construction tends to balance out effects of line voltage variation. In addition, electronic regulation is used on the plate supply for the logarithmic stage and direct-coupled amplifier. The stability of the gear is sufficient so that measurements remain accurate to within one db over long periods.

A small motor synchronized with the paper drive on the recording meter slowly changes the frequency of the oscillator driving the loudspeaker. The speed at which the oscillator frequency can be varied is dependent on the time constant of the rectifiers, which is relatively long. Even with this restriction, however, it only takes three minutes to traverse the frequency range from 30 to 15,000 cycles.

The curved coordinates produced by the meter are not as convenient to use as rectangular coordinates, but when a transparent scale marked in frequency is laid over the chart the sensitivity at any frequency can readily be read off.

For the low-frequency test in the tube no pulsing is used. The oscillator frequency is simply varied slowly as the response is plotted. For the high-frequency test the loudspeaker signal must be pulsed. This is done by a motor-driven commutator-type switch which shorts the oscillator signal except for the period of the pulse. Other commutators mounted on the same shaft short the microphone channels for a slightly longer period, clipping the transients from the beginning and end of the loudspeaker pulse. These commutators have to be phased on the shaft to allow for the time interval taken by the sound in traveling from the loudspeaker to each microphone.

It is difficult to find a loudspeaker or any sound source that has an output independent of frequency, but since this method compares the outputs of two microphones it does not greatly matter what variations occur in the sound output of the loudspeaker. However, to maintain approximately constant sound level at the microphone and to insure that the 46-db range of the voltmeter is not exceeded, a portion of the output of the standard flat-response microphone is fed to the automatic pressure control, a variable-gain amplifier in the loudspeaker circuit. Here it controls the signal fed to the loudspeaker, increasing the output when the loudspeaker response drops, and decreasing the output when it tends to increase.

The cathode-ray oscilloscope mounted in the rack is useful for visual checks on wave form. It quickly shows up, for example, the characteristic distortion produced in a velocity microphone when the ribbon strikes a pole piece during part of a cycle. The picture of the pulse received by a microphone will show up excessive distortion if present, but unfortunately the pulsing system is not easily adapted for distortion checks, although very satisfactory for response measurements. When checking loudspeakers the shape of the pulse is very useful for giving a qualitative measure of the transient response.

Polar Response Curves

For normal tests the microphone is terminated at the input of the rack in a resistive load of 500 ohms, corresponding to the input impedance of standard speech equipment. The response curve then includes the loading effect of the termination on the internal impedance of the microphone, an effect which in most microphones reduces the sensitivity at the higher frequencies. If desired, other terminations may be selected by a panel switch. The stand carrying the microphone under test can be rotated by a small motor for the automatic plotting of polar response curves.

Besides measuring the response of microphones, the equipment using the pulsing system can be used

to measure the response and polar distribution of loudspeakers above 1,000 cycles. For this test the standard microphone is placed in front of the loudspeaker to be tested, and a portion of the voltage applied to the voice coil is fed to one of the microphone channels in the rack. The curve plotted is the acoustic output of the loudspeaker for constant voltage on the voice coil, corresponding to the response that would be obtained if the loudspeaker were fed from a source having zero internal impedance. The response curve for other source impedances can be calculated from impedance measurements, or quickly plotted by placing the desired impedance in series with the voice coil after the point at which the comparison voltage is picked off.

Conclusion

The equipment described has been in routine use for almost a year. Since the calibration procedure is rapid and almost automatic the effects of adjustments on the microphones can be quickly seen and the best adjustment readily made.

The equipment has also been used to check new models of microphones, to measure the response and directional pattern of monitor loudspeakers, and for miscellaneous measurements, such as finding the transmission loss of loudspeaker grille cloth. If in the future a free-field room should become available the equipment can be used as it stands, simply by not using the pulsing switches. The equipment can also be readily adapted for more general laboratory purposes, such as measuring and plotting the response of filters or pickups.

Editor's Note—This paper was completed shortly before the death of the author, and was forwarded to *ELECTRONICS* by William G. Richardson, Transmission and Development Engineer with Canadian Broadcasting Corporation in Montreal.

REFERENCES

- (1) Frank Massa, Working Standard for Sound Pressure Measurements, *Journal of the Acoustical Society of America*, vol 17, p 23, 1945.
- (2) Walter Ives, A Logarithmic Indicating Instrument for the Measurement of Radio Noise Voltages, Master's Thesis at McGill University, Sept. 1946.

By **DAVID BAKER**

*Architect
Electronics Division
Bureau of Ships
U. S. Navy
Washington, D. C.*

Design of a

Naval Communication



Exterior of Dixon, California station. Holes under cornice are for feeders

New unit planned for pleasing appearance, operation by minimum of personnel, and capable of rational expansion stands at hub of rhombic array system. Deterioration of reinforced concrete structure is inhibited by novel method of bonding the rods

TO SET the best possible example in its postwar construction, the Office of the Assistant Chief of the Bureau of Ships for Electronics, in cooperation with the Bureau of Yards and Docks, has attempted to evolve a basic layout for the United States Naval Radio Transmitting Station at Dixon, California, which will function with a minimum number of personnel, provide low maintenance cost, and solve all probable expansions in the future.

The building expresses a definite architectural character rather than a box-like interpretation, by locating the columns which support the roof loads on the outside of the exterior wall, on centers of about 13 by 40 feet. This arrangement provides for a clear wall surface on the interior of the building and allows for ease of cleaning and lowered maintenance cost. It provides unobstructed maximum working area around the transmitters, and makes possible the running of transmission lines without any obstructions whatsoever within the transmitting room.

In order to obtain a flexible

arrangement for routing incoming transmission lines to the various transmitters, seventy-five pairs of entering insulators are located beneath the protecting cornice of the building. Thus, a line can be pulled tight and held fast on the transmission line anchor, then looped under the cornice and into the feed-through insulator.

Internal Wiring

Cableways are used for cable, conduit, bus bars, piping, and the like, in lieu of an alternate design which would have necessitated that the transmission room be on a second floor, with access to cables arranged in continuous hangers from the ceiling below. Low cost in installing cable is made possible by the ease with which it can be rolled off reels over the main cableways without moving any equipment to do so. The equipment is installed directly over an adjacent system of small feeder trenches.

The floor material finish is terrazzo, ground smooth and divided into squares. The brass strips ordinarily used for dividing terrazzo

could prove electrically dangerous to the personnel in the transmitter room, so plastic strips are used instead. Contrasted with a painted concrete surface, battleship linoleum, or asphalt tile, terrazzo fully meets the need of a good wearing surface capable of resisting heavy loads, and is easily maintained and kept clean.

Trucks for carrying equipment for the initial installation or any emergency find easy access through large aluminum sliding end doors. An overhead rail for supporting a hoist is utilized over the end bays of the transmitter room. Thus, equipment is lifted from a truck by means of the hoist to a hand-steered electric-powered transporter.

Air Conditioning

This windowless building, save for the administrative portion and the lavatory, is ideal for air conditioning. In addition, it keeps the building insect-proof, a vital consideration, because bugs have a tendency to work their way into transmitter equipment. The out-

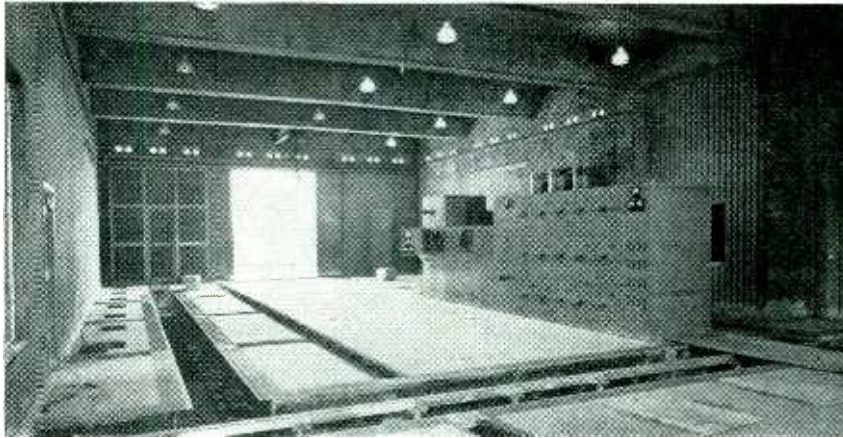

Interior showing main switchgear, main and branch cable runways with covers removed

Station

side wall acts as a blast-resisting surface and the inside face provides a good light-reflecting surface.

In the normal course of operation, sufficient heat is generated by the transmitters to heat the building. This warm air is therefore recirculated and utilized for heating, being tempered by cool fresh air. A cooling system for warm weather utilizes the same duct system. The air in the ducts is maintained at a constant 70 to 75 degrees in the summer and winter. In the event of a transmitter shutdown, a boiler is provided as an auxiliary source of heat. Controls provide for automatic operation.

Designed for construction when future commitments so require is a vhf and shf tower which will be located over the loading platform at the rear. The cantilever floor of the tower provides a 360-degree area for spacing line-of-sight link antennas of the parabolic-reflector type.

Antenna switching will be accomplished by a system of hand-wheel switches that may later be remote controlled. The completed unit will be suspended from cross members framed into sidewall angles or channels in lieu of suspending the units from the ceiling or concrete girders.

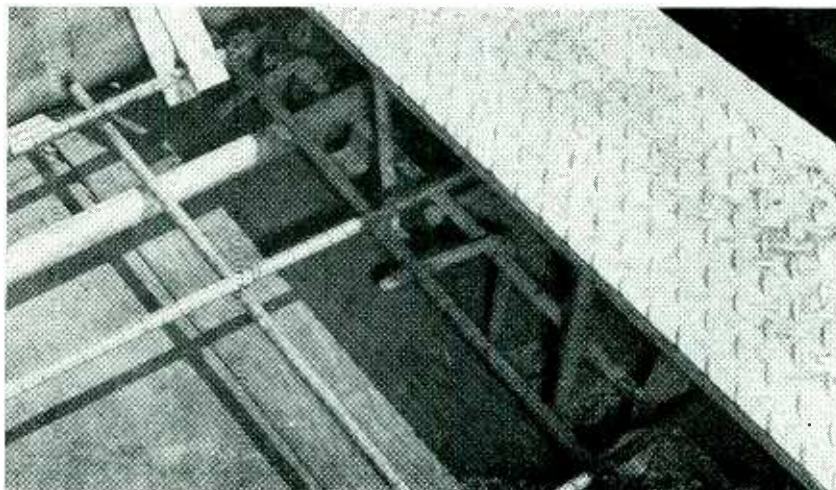

Detail of brazed bonds between reinforcing rods, structural members and conduit

The antenna arrangement consists of a number of rhombic transmitting antennas erected circularly from the transmitter building. The antennas are oriented in the specific direction in which the maximum signal is desired. The transmission lines run directly from the antenna to the antenna switching system, so that any transmitter can be connected to any transmission line. The transmission lines are 600-ohm open-wire type. The transmission-line anchors form an integral part of the building cornice design and, together with the antenna feed-through insulator, give the radio transmitting station its definite character.

Some previously erected reinforced concrete transmitting buildings have suffered partial disintegration owing to expansion of reinforcing rods at a rate faster than that of the concrete surrounding them. This heating was caused by absorption of stray radio-frequency energy. Appreciable energy can be picked up by rods that are resonant at full, half, or quarter wavelengths. Negligible energy is picked up at an eighth wave or less.

Grounding

Since the shortest wave at which appreciable power is to be radiated at the station is 12 meters, only ungrounded rods above 5 feet in length needed special treatment. Accordingly, all steel reinforcing rods are rigidly and continuously bonded to ground by arc welding or brazing. In addition, bonding wires are provided to ground as a precaution against breakage of the rod junctions during the vibrating of the concrete in the molds. Metal doors, window frames, and the like are bonded to the reinforcing steel. Conduit is tied in at least every 20 feet. All mechanical equipment is grounded separately with No. 6 or larger copper wire. The grounding system in the cableways consists of a network of $\frac{1}{2} \times 2$ -inch copper bars. Ground rods are $\frac{5}{8} \times 10$ -foot copper-covered steel with No. 2/0 stranded copper cable for connection to the reinforcing steel. This system is then tied in with the external underground network surrounding the station, and used with the antenna systems.

DEVELOPMENT of new techniques for improving the response of servomechanisms has made it possible to apply them to an ever increasing number of uses. These techniques are based upon: (1) improved methods of analysis which show the factors that limit servomechanism response, and (2) the design, or redesign, of components which improve the response.

This article describes a new and simple method for designing stabilization circuits which may be used to improve servomechanism response, and offers a new approach to the design of stabilization circuits in general. The design of these stabilization circuits is based upon the principle that *a circuit, having a transfer function which is the inverse of the transfer function of the servomechanism, can be used as a stabilization network, and that this circuit can be approximated by a feedback amplifier having in its feedback path a network with a transfer function proportional to that of the servomechanism.*

Consequently the first step in obtaining such a stabilization circuit is to design a circuit having a transfer function proportional to the transfer function of the unimproved servomechanism. This latter circuit will be referred to as the equivalent servomechanism circuit or the equivalent circuit.

Obtaining Equivalent Circuit

The first step in designing the equivalent circuit is to set up the general form of the equivalent network. The second step is then to determine the parameters of this network. These two steps are illustrated by the examples of Fig. 1.

In Fig. 1A is shown the schematic of a simple servomechanism, using a motor-generator set as a power control component of the servomechanism. Figure 1B is the approximate electromechanical equivalent of Fig. 1A. Transfer functions of the system are expressed by the equations. This approximation is justifiable for the operating range of interest because, in general, the armature circuit time constant is short compared to the rotor time constant.

Figure 1C shows the general form of an electrical network hav-

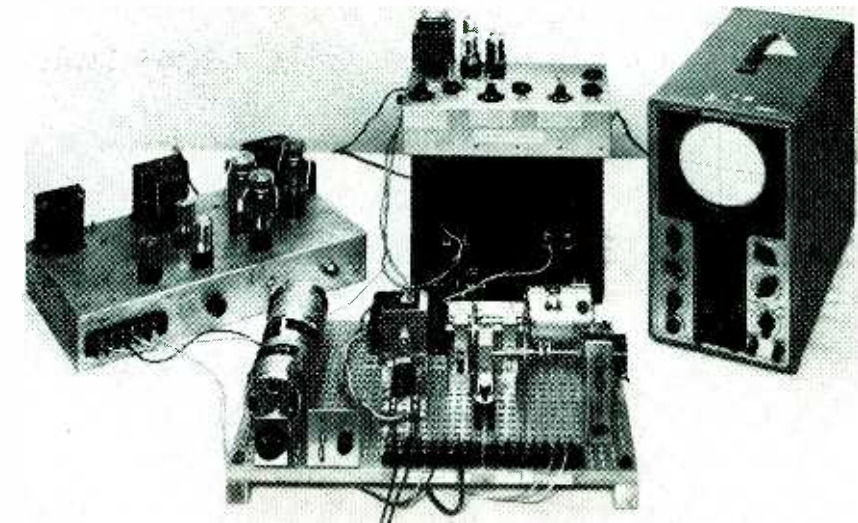

Laboratory equipment used in determining feedback constants includes the uncompensated servo (foreground), its amplifier (left), the adjustable feedback circuit whose parameters are to be found (background), and an oscilloscope

Stabilizing Servomechanisms

By this laboratory technique, constants of feedback stabilization circuits for servomechanisms can be quickly determined without resorting to mathematical computations, thus making it feasible to design and adjust servos for heretofore impracticable applications

By **DONALD McDONALD**

*Head of Controls Group
Aeronautical Research Center, University of Michigan
Willow Run Airport, Ypsilanti, Mich.*

ing a transfer function of the same type as the velocity transfer function of the servomechanism. Comparison of the analytical expressions for the transfer function of the equivalent circuit of Fig. 1C, and for the servomechanism, demonstrates the equivalence of the network. The approximation in Fig. 1B was made so that the circuit of Fig. 1C could be composed only of R-C networks, thus simplifying the

adjustment of the circuit of Fig. 1D.

Figure 1D is a schematic of the setup used in determining the values of the parameters of the equivalent circuit. This setup consists of the unimproved open-cycle servomechanism, the equivalent circuit, a variable-frequency sinusoidal-voltage source, a d-c tachometer, and an oscilloscope having d-c amplifiers to drive its deflection plates.

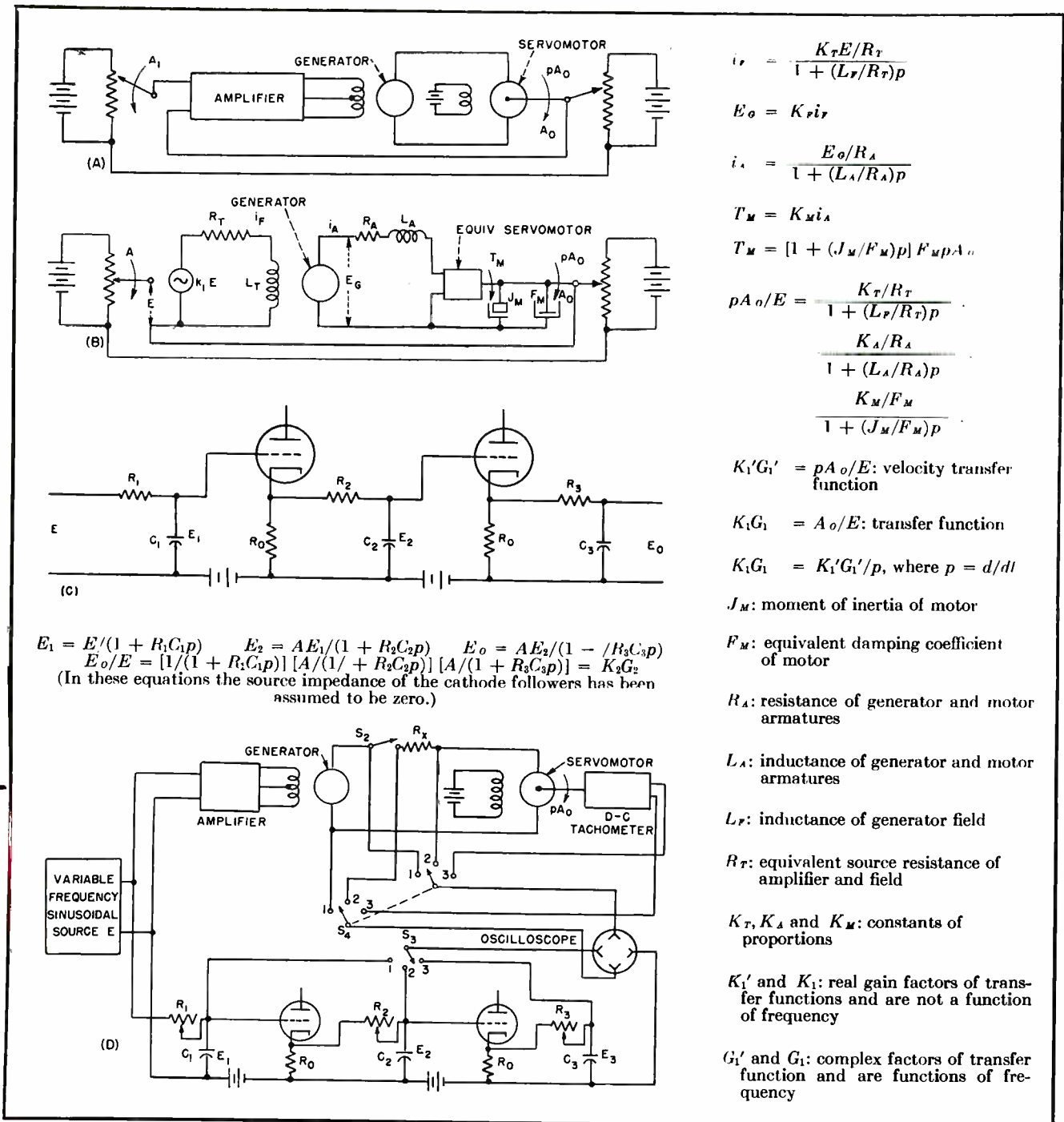

FIG. 1—Method is based on theoretical comparison of servo (A) and (B) with feedback circuit (C). By adjusting the responses of the two systems to be the same (D) proper compensation is obtained

(This setup, in a simplified form, was first developed by the author in 1945 while a member of the MIT Servomechanisms Laboratory.)

With switch S_2 open, the selector switches S_3 and S_4 in position 1, the voltage E_1 of the equivalent circuit and the open-circuit output-voltage E_o of the generator are placed across the deflection plates of the oscilloscope. By adjusting resistor

R_1 , it is possible to reduce the elliptical figure on the oscilloscope screen to a straight line. Then the first factors of the velocity transfer functions of the actual servomechanism and of the equivalent circuit are the same.

In essence, when the ellipse becomes a straight line, the phase shift of the first stage of the equivalent circuit has been made equal to the phase shift of the first stage of

the actual servomechanism. Therefore, the first factors of the velocity transfer functions of the actual servomechanism and of the equivalent circuit are the same because the servomechanism contains only minimum phase networks.

The frequency of the variable-frequency sinusoidal-voltage source should be varied over a large frequency range to insure that the first factors of the velocity transfer

functions of the actual servomechanism and of the equivalent circuit are the same for all frequencies. Nonlinearities in the servomechanism may make it impossible to obtain one value of R_1 which reduces the elliptical figure to a straight line for all frequencies. If this occurs, then that value of R_1 which minimizes the width of the ellipse over the frequency range of interest should be chosen.

With switch S_2 closed, selector switches S_3 and S_4 in position 2, and with the rotor of the servo motor locked, the voltage E_2 of the equivalent circuit and a voltage proportional to the current i_4 of Fig. 1B are placed across the deflection plates of the oscilloscope. By adjusting resistor R_2 it is possible to reduce the elliptical figure to a straight line, whereupon the second factors of the velocity transfer functions of the actual servomechanism and of the equivalent circuit are the same.

In a similar fashion, with switch S_2 closed and selector switches S_3 and S_4 in position 3, the voltage E_3 of the equivalent circuit and a voltage proportional to pA_0 of the servo

motor are placed across the deflection plates of the oscilloscope. By proper adjustment of the resistor R_3 it is again possible to minimize the width of the ellipse and make the third factors of the velocity transfer functions of the actual servomechanism and of the equivalent circuit the same.

Upon conclusion of these three steps, the transfer function of the equivalent circuit is proportional to the velocity transfer function of the unimproved servomechanism. As mentioned before, nonlinearities in the servomechanism may make it necessary to choose values of R_1 , R_2 , and R_3 which tend to minimize the width of the ellipse over the frequency range of interest.

From simple network considerations of the equivalent circuit, it is possible to determine what factors in the unimproved servomechanism limit its response. If these factors cannot be removed by redesign, then a stabilization network must be used.

Stabilization Network

The schematic diagram of Fig. 2A shows how the equivalent cir-

cuit can be incorporated into a feedback amplifier and thus create a stabilization network. The resulting feedback amplifier will be referred to as the stabilization feedback amplifier.

In Fig. 2A the unimproved open-cycle servomechanism, represented by the transfer function K_1G_1 of Fig. 1, is cascaded with the stabilization feedback amplifier having a transfer function K_2G_2 . The stabilization feedback amplifier has a constant gain amplifier K_3 in its forward branch, and the equivalent circuit of Fig. 1C in its feedback.

The expressions of Fig. 2A demonstrate that if K_3 is large enough, K_4G_4 approaches $1/K_2G_2$. It is further shown that the overall transfer function K_5G_5 reduces to $1/Bp$ and A_0/A_1 to $1/(1 + Bp)$.

Thus by combining the equivalent circuit of the velocity transfer function of a servomechanism with an amplifier, it is possible to obtain a stabilization network which tends to reduce both the transfer function of the compensated servomechanism to $1/Bp$, and the output-to-input ratio to $1/(1 + Bp)$.

If the output-to-input ratio

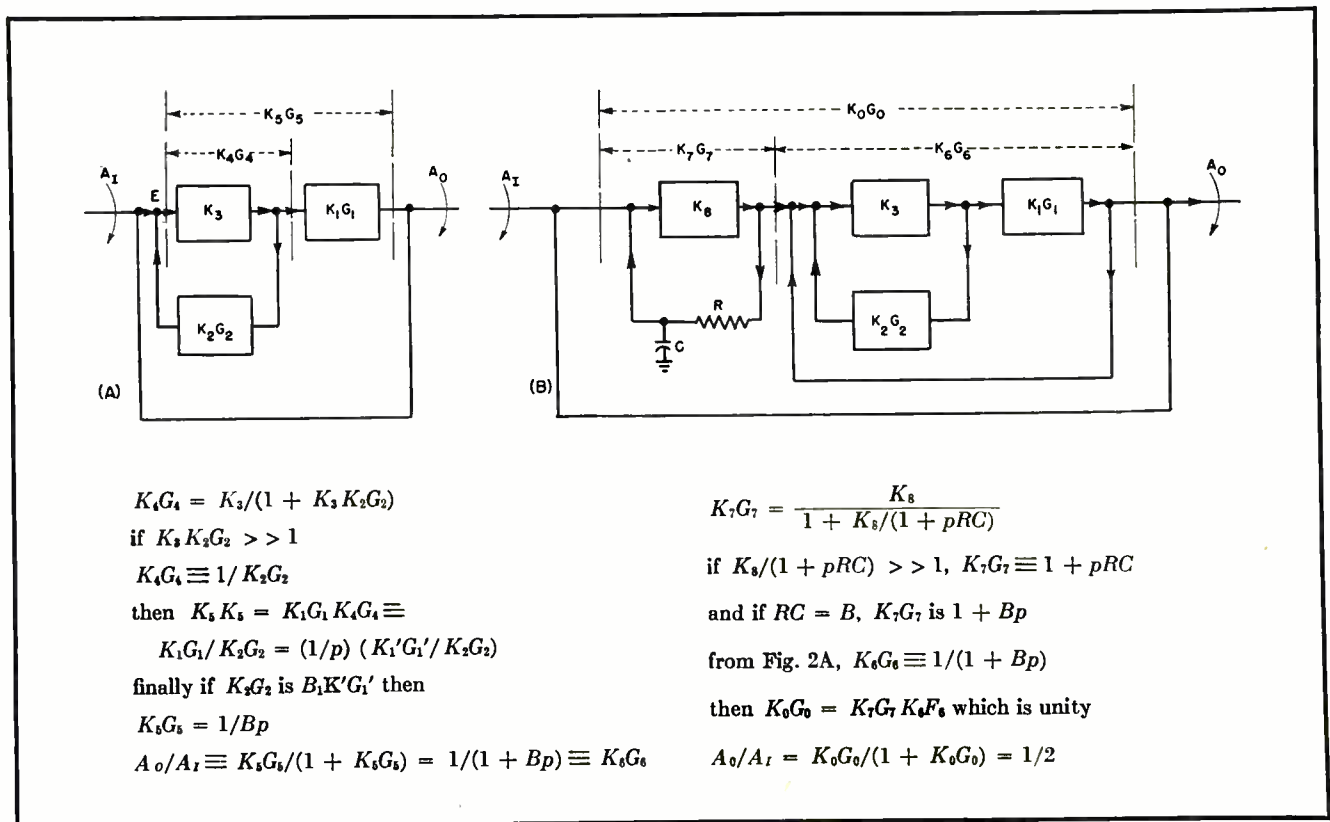

FIG. 2—When necessary, additional feedback loops can be added by the basic technique. The experimental method helps to assure that the circuit parameters of the multiloop system will not produce oscillation

A_o/A_i of the compensated servomechanism of Fig. 2A is considered to be a transfer function K_oG_o , it is possible to design an equivalent network for this transfer function. This equivalent network may be obtained by comparing K_oG_o to a single R-C stage in a manner similar to that demonstrated in Fig. 1D.

This single stage equivalent R-C network can be used as the feedback branch of a stabilization feedback amplifier and the resulting feedback amplifier cascaded with K_oG_o , as shown in Fig. 2B. If this is done, the expressions of Fig. 2B show that K_oG_o , the transfer function of this stabilization feedback amplifier, approaches $1+Bp$, and the overall transfer function K_oG_o of the twice-compensated servomechanism approaches unity. Therefore, in the limit, A_o becomes directly proportional to A_i . Although not shown schematically in Fig. 2, the gain of the system can be increased with the application of the principle outlined above.

In the examples of Fig. 2, it was assumed that the transfer function K_oG_o approached $1/(1+Bp)$ and that, therefore, the R-C product of the equivalent circuit of K_oG_o should equal B . In general, it may not be possible to reduce K_oG_o to exactly $1/Bp$, and therefore K_oG_o will be slightly more complex than $1/(1+Bp)$. Consequently, when comparing the equivalent R-C network to K_oG_o , a value of R should be chosen which tends to minimize the width of the ellipse over the frequency range of interest.

Figure 2 shows that it is possible to enhance the stability of a servomechanism by first cascading the open-cycle servomechanism with a stabilization feedback amplifier containing the equivalent circuit of its transfer function, and then by closing the servo feedback loop around these two cascaded components. This procedure may be repeated successively until the desired improvement in the response of the servomechanism has been achieved.

Practical Considerations

In any servomechanism it may not be necessary to compensate for every time delay or its equivalent. Consequently, the equivalent circuit

used in the stabilization feedback amplifier need not always contain all of the terms of the complete velocity transfer function. In fact, it may be more practical not only to reduce the number of terms in the equivalent transfer function, but also to approximate the remaining ones.

Following this philosophy, an approximate equivalent circuit can be designed which is composed of only one or two R-C networks or an RLC network. With the setup of Fig. 1D these R-C or RLC networks can be made equivalent for only those frequencies where the maximum phase shift and resonance in the servomechanism response has been observed. Then an approximate stabilization feedback amplifier can be constructed, and the procedure of Fig. 2A followed. The remaining uncompensated factors which limit the response of the servomechanism can either be neglected, or removed, by another approximate equivalent circuit and stabilization feedback amplifier, as was done in Fig. 2B.

The number of cathode followers used in the equivalent circuit may be reduced if the impedance of one R-C network is several times greater than the impedance of the preceding network, thus making it unnecessary to isolate these two networks.

In some cases the inertia of the d-c tachometer of Fig. 1D, might be comparable to the inertia of the servomotor which would change the effective characteristics of the servomotor. If this condition arises, the d-c tachometer should be coupled to the motor through a gear reduction. This gearing down usually can be accomplished by coupling the d-c tachometer into the output gear train at some convenient gear mesh.

It is a worthwhile precaution, when combining the equivalent circuit with an amplifier, to form a stabilization feedback amplifier to use no more than two time constants, or their equivalent, in one feedback branch. Otherwise the possibility exists that the stabilization feedback amplifier may oscillate itself. If there are more than two time constants, or their equivalent, in an equivalent circuit, then

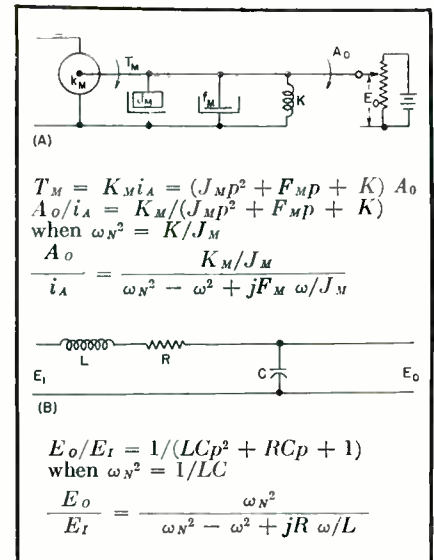

FIG. 3—Spring loaded servos can be compensated by an additional step in the method

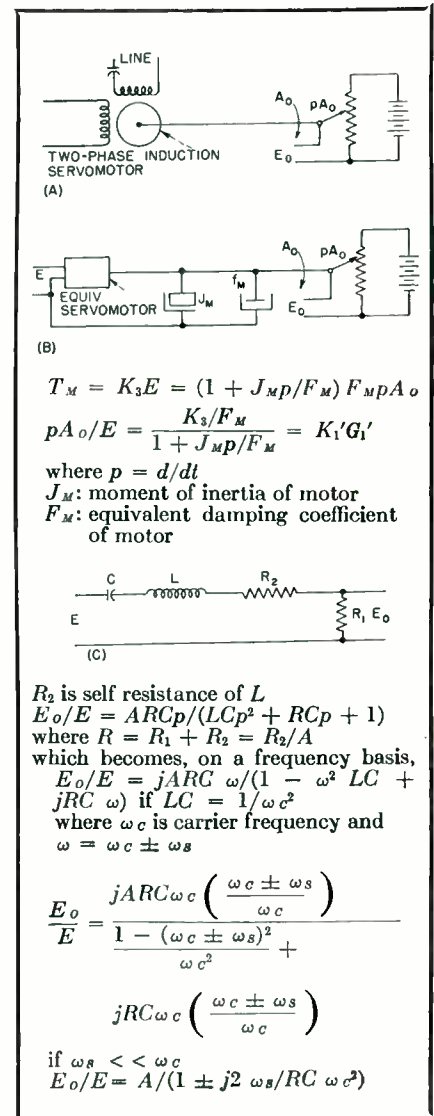

FIG. 4—Alternating-current servomechanisms can be handled similarly to d-c ones, but see Fig. 5

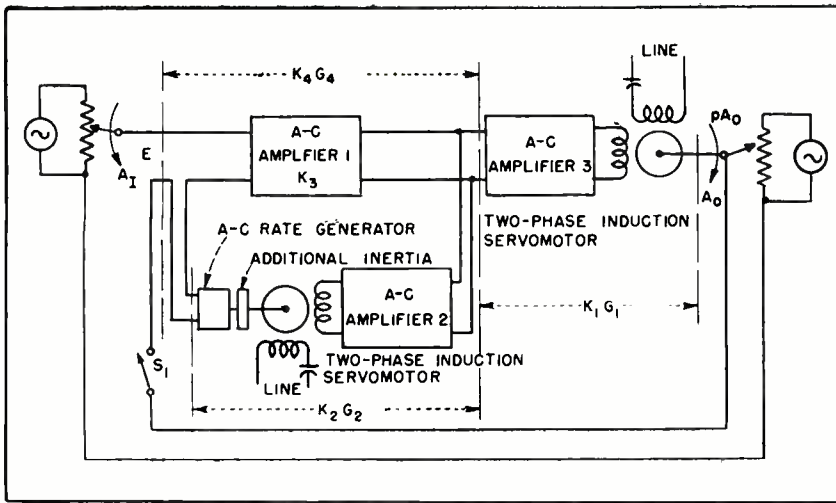

FIG. 5—Stabilizing a-c servos can be simplified if a motor-generator set is used in the feedback path instead of a passive network

several stabilization feedback amplifiers should be used.

Good results can be obtained from a stabilization feedback amplifier with a value of K_3 , in Fig. 2A, of only 7 to 10. The overall gain K_1 of the stabilization feedback amplifier can be made any value desired by proper choice of the value of K_2 of the equivalent circuit. It is worth noting that the amplifier K_3 does not have to be an additional amplifier, but may be a stage of K_1 .

Case of Spring Loading

In many applications the output motion of the servomotor is restrained by a spring, as in the case of a torque servomotor actuating the pilot valve of a hydraulic system. Figure 3A shows the electromechanical circuit of a servomotor restrained by a spring of stiffness K_1 and Fig. 3B shows its equivalent circuit. In this example the servomechanism amplifier stages are not shown, and the servomotor is assumed to operate on d-c.

The output voltage E_o of the equivalent circuit may be made proportional to the output voltage E_o of the physical system in a manner similar to that demonstrated in Fig. 1D. In this case it is not possible to subdivide the equivalent circuit or the electromechanical circuit so that only one variable may be adjusted, or compared, at a time. This difficulty may be overcome by noting that at high frequencies the voltage E_o is primarily a function

of the L-C product, and that at low frequencies it is primarily a function of the R-C product. Therefore, with the frequency of the variable-frequency sinusoidal-voltage source high, C should be adjusted until the width of the ellipse has been minimized. Then the frequency should be reduced until the width of the ellipse is quite large. At this frequency the value of R should be adjusted until the width of the ellipse has again been minimized. Estimate of approximate value of L and C may be obtained by visual observation of natural frequency of unexcited servomotor and spring.

So far, the servomechanisms described have been d-c types. Figure 4A shows part of a two-phase induction motor servomechanism and Fig. 4B its electromechanical equivalent. The amplifier components have not been considered because, in general, straightforward amplification stages act upon the sidebands of the modulated suppressed-carrier signals and therefore produce only very small time delays. On the other hand, the servomotor essentially demodulates the modulated suppressed-carrier signal and acts only upon the envelope or modulating signal, and thus may produce large time delays.

Compensating A-C Servos

Figure 4C is a schematic of the equivalent circuit of the two-phase induction servomotor. As will be noted from the analytical expressions of Fig. 4C, the equivalence of

this circuit holds only over a limited region of the modulating signal frequencies. This situation is generally true of any a-c network containing only linear elements.

The parameters of this equivalent circuit may be determined by the procedure demonstrated in Fig. 1D. As there are two variables, L and R to be adjusted together, tuning L and C so that they resonate at the carrier frequency leaves only R to be adjusted.

As mentioned before, the a-c servomotor demodulates the modulated suppressed-carrier signal, and, therefore, it is difficult with linear elements to synthesize a network which is the equivalent of the a-c servomotor. This factor makes it quite difficult to obtain as much stabilization from linear a-c networks as from linear d-c ones. It is, therefore, suggested that a small two-phase motor, directly coupled to a small a-c rate generator, be used as the equivalent circuit for an a-c servomechanism. This small two-phase motor and generator combination can then be used as the feedback branch of a stabilization feedback amplifier, and the resulting amplifier will serve as a stabilization network for two-phase servomechanisms. Figure 5 demonstrates the method by which this may be accomplished.

The a-c amplifier No. 2 of Fig. 5 does not need to be a separate amplifier, but may be a stage from either K_3 or a-c amplifier No. 3. A velocity signal proportional to the signal developed by an a-c rate generator can be obtained from the control phase of the small two-phase motor and thus eliminate the a-c rate generator from the circuit (see Fig. 5).

In review, the response of a servomechanism can be improved with the aid of an approximate stabilization feedback amplifier (Fig. 1D). Furthermore, if the response is not sufficiently improved after the use of a single stabilization network, additional networks may be added. The design of these additional networks usually is simplified by the use of a minor feedback loop around the first stabilization network and the unimproved servomechanism which are in cascade. This effect is demonstrated in Fig. 2B.

CINCH SOCKETS ARE STANDARD

ENGINEERING
DEPT.

"A LONG LINE OF FIRSTS"

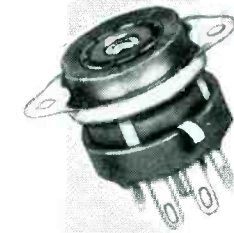
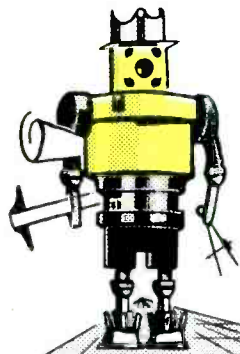

... testifies to the confidence of the electronics manufacturer in Cinch. Behind "locked doors" the experimental engineers work on your design

problems, exploiting the broad electrical experience that has contributed so much in the development of electronics and related products. In the Cinch designing room many of radio's most serviceable features, represented by small metal plastic parts, were created and perfected. For example: The sub-miniature and the grip-pin type socket. Cinch offers a complete metal plastic service for small and intricate assemblies.

AVAILABLE AT LEADING ELECTRONIC JOBBERS ... everywhere

P A T E N T S P E N D I N G



Sub-miniature for "printed electronic circuits," No. 54A13124







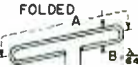
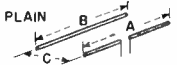

Grip-pin type miniature socket, 1" mtg. center, No. 56F12865

CINCH MANUFACTURING CORPORATION
2335 WEST VAN BUREN STREET CHICAGO 12, ILLINOIS
Subsidiary of United-Carr Fastener Corporation - Cambridge 42, Massachusetts

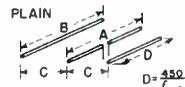
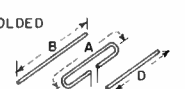
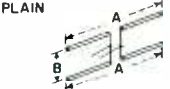
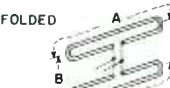
F-M and Television Receiving Antennas

By GEORGE P. KEARSE Senior Engineer, American Phenolic Corp., Chicago

Type of Antenna; Length in Feet $A = \frac{468}{f_{mc}}$ $B = \frac{492}{f_{mc}}$ $C = \frac{246}{f_{mc}}$	Approximate Terminal Impedance in Ohms	Radiation Pattern		Gain over Dipole		Recommended Feed Line, Application and Remarks
		Electric, in Line with Radiator	Magnetic, Right Angles to Radiator	Power	Decibels	
DIPOLE PLAIN  FOLDED 	72 300	Figure of eight, bidirectional broadside to elements	Circular	Unity	Zero	PLAIN—75-ohm coaxial. FOLDED—300-ohm twin-lead. Use of twin-lead to feed plain dipole gives broadband operation but extreme loss in gain; not recommended General two-direction coverage for receiving in areas of moderate signal strength. Folded dipole slightly more broadband than plain. If 300-ohm twin-lead is used as radiator, do not shorten length A for propagation factor
DIPOLE AND REFLECTOR PLAIN  FOLDED 	60 250	Uni-directional broadside to radiator	Half of figure of eight	2 to 2½ times	3 to 4 db	PLAIN—50-ohm or 75-ohm coaxial; 75-ohm cable is more broadbanded. FOLDED—300-ohm twin-lead Single-direction coverage, high front-to-back ratio and high gain. Recommended for use in areas of low signal strength and where single-direction radiation pattern is desired. Folded radiator slightly increases bandwidth. If array is to be used over narrow band, calculate length B at lowest frequency desired. Reducing C to 0.15 λ (in air) gives higher gain but lowers impedance and reduces bandwidth
DIPOLE, REFLECTOR, AND DIRECTOR PLAIN  FOLDED 	20 to 30 80 to 120	Uni-directional broadside to radiator	Half of figure of eight	2½ to 4 times	4 to 6 db	PLAIN—50-ohm coaxial. If better impedance match is desired, use quarter-wave matching transformer; impedance of transformer should be square root of product of line and antenna impedances. FOLDED—75-ohm coaxial or 95-ohm twin coaxial Single-direction coverage, high front-to-back ratio and high gain. Very frequency-sensitive. Narrow bandwidth. Recommended for use in areas of very low signal strength and for one frequency only. Spacing is λ/4; reducing C to 0.15λ for reflector and 0.1λ for director (in air) increases gain but reduces impedance to 8 to 10 ohms for plain and 30 to 40 ohms for folded dipole
STACKED DIPOLES PLAIN  FOLDED 	35 to 40 150	Figure of eight, bidirectional broadside to elements	Figure of eight, bidirectional broadside to elements	2 to 2½ times	3 to 4 db	PLAIN—50-ohm coaxial. FOLDED—150-ohm twin-lead. Quarter-wave matching transformer may be used for 300-ohm twin-lead if desired, but will be frequency-sensitive High-gain array for use in areas of low signal strength and where two-direction coverage is needed. Useful over moderate frequency band. Value of B may be reduced to λ/8 (in air) if desired, with a reduction in gain
STACKED DIPOLES AND REFLECTORS PLAIN  FOLDED 	25 to 30 100 to 120	Uni-directional broadside to elements	Uni-directional broadside to elements	4 to 5 times	6 to 7 db	PLAIN—50-ohm coaxial cable. Quarter-wave matching transformer may be used for better impedance match but will be frequency-sensitive. FOLDED—95-ohm twin coaxial cable or 150-ohm twin-lead High-gain array for use in areas of low signal strength and where single-direction coverage is desired. Useful over relatively narrow band. Value of C may be reduced to 0.15λ (in air) with an increase in gain. Value of impedance will be lower and array will be more frequency-sensitive. Value of D may be reduced to λ/8 (in air) if desired, with a reduction in gain
TURNSTILE PLAIN  FOLDED 	35 to 40 150	Circular. Radiation pattern changes with frequency	Figure of eight	0.7 of a dipole	-1½ db	PLAIN—50-ohm coaxial cable. FOLDED—150-ohm twin-lead Omnidirectional coverage for use in areas of high signal strength. Low gain. Very frequency-sensitive; radiation pattern approximates dipole pattern rotated 45° from axis of either dipole when operated off frequency. With this array, two dipoles are connected together with a quarter-wave phasing section of 75-ohm coaxial cable for plain dipoles and 300-ohm twin-lead for folded dipoles. Length of phasing section must be corrected for propagation constant of line used

A New, Better LEVER ACTION SWITCH!

with positive indexing
or spring return

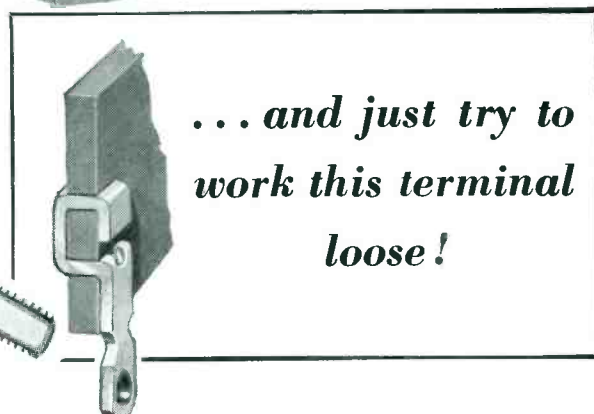
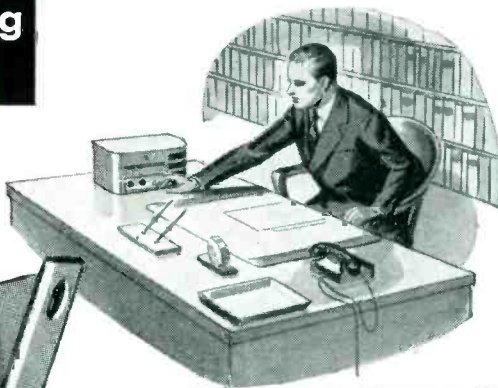
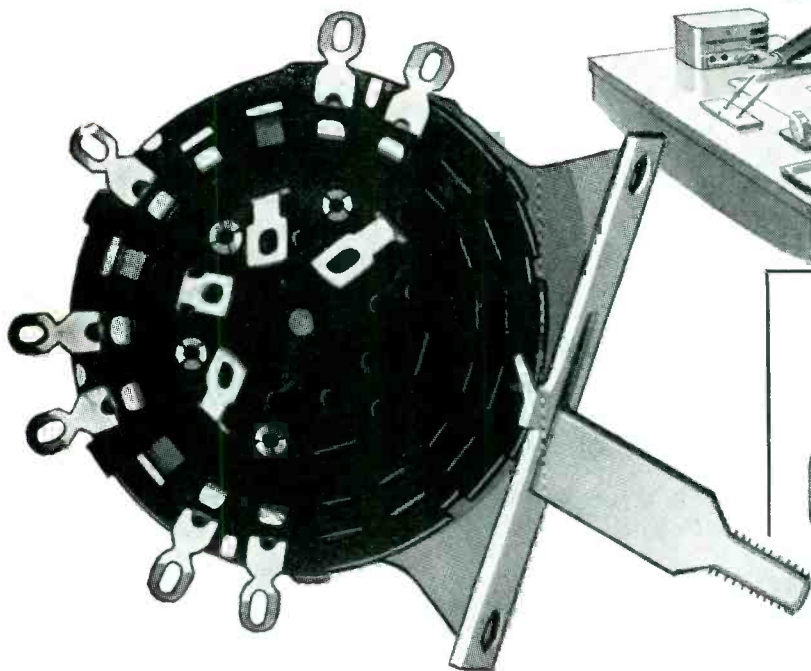

Although only recently developed and placed on the market, this lever action switch is in big demand. No wonder! It is ideally suited to intercommunications, centralized radio, sound distribution and public address equipment. It gives you a choice of positive indexing or spring return. It is as dependable as the leaf spring telephone type switch, yet available at much lower cost.

Consider some of the other "plus" features that set this switch apart: Self-holding terminals of exclusive design are securely clinched to the stator without rivets or eyelets (just try to pull them loose!). All terminals, contacts and ground rings are silver plated for low contact resistance. Constant tension of rotor contact members provides a dependable, self-cleaning action. Insulation is of the highest-grade phenolic.

Positive indexing types of this switch have 48 standard circuit combinations, 24 shorting and 24 positive non-

shorting. Spring return types have 17 standard shorting and 17 positive non-shorting circuit combinations. Write for engineering data folder or see your nearest Mallory distributor.

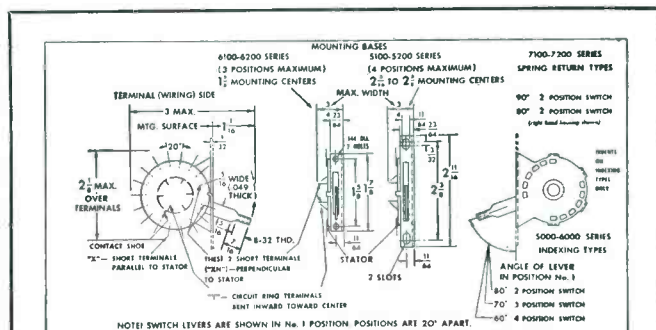

Send for Engineering Data Folder

The Engineering Data Folder for the new Mallory Lever Action Switch contains complete specifications, available circuit combinations with respective terminal locations, dimensional drawings—everything the engineer needs to assist in selection of the particular Mallory Lever Action Switch to best handle the application.

P. R. MALLORY & CO. Inc.
MALLORY SWITCHES
(ELECTRONIC, INDUSTRIAL and APPLIANCE)

P. R. MALLORY & CO., Inc., INDIANAPOLIS 6, INDIANA

TUBES AT WORK

Including INDUSTRIAL CONTROL

Edited by VIN ZELUFF

Automatic Rat-Catcher Circuit.....	120
Pulsed Underwater Acoustic Measurements.....	120
Electronic Fuse.....	136
Improving Performance of Milliwatt Relays.....	140
Camera Shutter Timer.....	148
Telecontrolled Clocks.....	152
Sound Flashlight for the Blind.....	156

Automatic Rat-Catcher Circuit

AUTOMATIC electrocution of rats and other rodents is accomplished by the machine illustrated in the accompanying photograph. It is designed to be placed on a rat runway in a factory building in the food or other industry having a general sanitation problem.

The unit illustrated is normally contained inside a metal case that is open at each bottom end to provide the rat runway. When a rodent enters the runway he intercepts a beam of light from a projec-

tion lamp (through the series 60-watt lamps) and the potential is applied to the rat for a lethal period of about 120 seconds. When electrocution is completed, the rat is lifted, still held by the grids, to a door at the side of the metal case which opens to allow ejection. A motor-driven mechanism carries out this ejection and resetting cycle in 30 seconds. At the

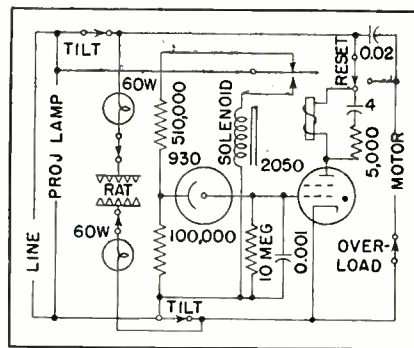

Circuit of the rodent electrocution machine

end of the cycle, the grids return to the ready or arming position and the ejection door closes.

During ejection, the plate voltage is removed from the 2050 thyatron and when the cycle is completed this connection is restored so that the tube is ready to be triggered by another pulse from the phototube, in turn caused by another rat. The technique is said to cause the rodent no pain, mutilation or freightened struggle by the manufacturers of the machine, LFC Corporation, Rochester, N. Y.

Pulsed Underwater Acoustic Measurements

BY GEORGE F. BREITWIESER

*Acoustics Laboratory
Massachusetts Institute of Technology
Cambridge, Massachusetts*

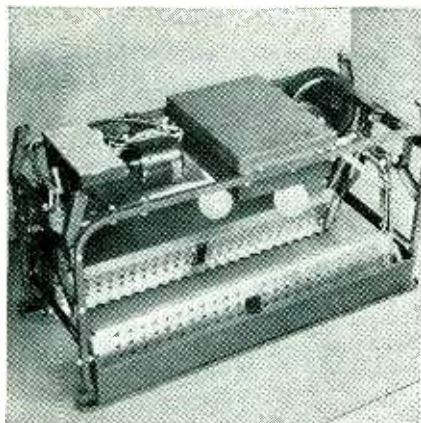

View of the rat catcher with metal case removed to show the electronic and mechanical features

UNDERWATER acoustic measurements in laboratory tanks are sometimes complicated by interfering waves reflected from the walls. Unless the tank is lined with highly absorbing material, steady state measurements are difficult to make, because standing waves of significant amplitude are almost always present.

This difficulty can be avoided; however, if measurements are made by a pulse technique in the short time interval before unwanted reflections can reach the receiver. Such measurement of reflections from a steel plate is illustrated in Fig. 1.

A burst of acoustic power is projected into the tank. Echoes are formed when this burst strikes the plate and the walls and before long these echoes fill the tank with complex wave patterns. The condition required for measurements is

shown in Fig. 1B. Here the outgoing burst has entirely passed, the echoes reflected from the walls have not yet reached the receiver, and the middle of the wave packet reflected from the plate is just at the receiver.

Figure 2 is a block layout of a reliable circuit which has been developed for making this kind of measurement. Only the useful middle section of the received signal is shown on an oscilloscope allowing the study of phase, amplitude, and wave shape of the reflected wave. The measurement cycle is repeated at a frequency which leaves time for reverberation to die out between bursts. Pulses formed at 60 cps from the a-c line actuate a submultiple generator which in turn delivers pulses at 10 to 60 per second. These pulses initiate the measurement cycle by controlling the transmitting and re-

tion lamp that shines into a phototube on the other side of the runway. The phototube triggers a 2050 thyatron, shown in the circuit diagram, which fires and energizes a relay that connects the line voltage to a solenoid. This in turn trips two metal grids having pointed projections and the grids snap together and hold the rat firmly.

The grids are maintained at the

**SPEED
ELECTRICAL
ASSEMBLY...**



with smooth inside bore of

DIEFLEX
VARNISHED TUBING PRODUCTS

Your product assembly will be quicker and easier if you use top-quality Dieflex products. Every one has smooth inside bore that makes it easy to use. It slips over bent wire, around corners, and into crowded places quickly, because wire ends won't catch on the smooth inside surfaces.

The many inherent advantages of Dieflex Tubing Products, including the smooth inside bore, extreme flexibility, thorough impregnation with oleoresinous baking-type insulating varnish, and the many other desirable features found in every piece, are reasons for the widespread use of Dieflex Varnished Tubing Products. Get these advantages for your own product. Dieflex is available with either a cotton or glass fiber base to meet your insulating requirements. Call your nearest representative for details.

DIEFLEX PRODUCTS LIST

MADE WITH BRAIDED COTTON SLEEVING BASE

VTA Grade A-1 Magneto Grade Varnished Tubings
VTA Grade B-1 Standard Grade Varnished Tubings
VTA Grades C-1 and C-2 Heavily Coated Saturated Sleeveings
VTA Grade C-3 Lightly Coated Saturated Sleeveings
Heavy Wall Varnished Tubings and Saturated Sleeveings

MADE WITH BRAIDED GLASS SLEEVING BASE

VTA Grade A-1 Magneto Grade Varnished Fiberglas Tubings
VTA Grade C-1 Extra Heavily Saturated Fiberglas Sleeveings
VTA Grade C-2 Heavily Saturated Fiberglas Sleeveings
VTA Grade C-3 Lightly Saturated Fiberglas Sleeveings
Silicone-Treated Fiberglas Varnished Tubings and Sleeveings

IMC Representatives

W. C. JOHNSON — PEORIA 5 — 101 Heinz Court
H. A. HOLDEN — MINNEAPOLIS 3 — 1208 Harmon Place
H. R. BRETHEN — DETROIT 2 — 15 Lawrence Ave.

Authorized Distributors

INSULATION and WIRES INCORPORATED

St. Louis 3, Mo. • Atlanta, Ga. • Boston 20, Mass.
Detroit 2, Mich. • Houston 2, Tex. • New York 7, N. Y.

TRI-STATE SUPPLY CORPORATIONS

Los Angeles 13, Cal. • San Francisco 7, Cal. • Seattle 4, Wash.

**INSULATION
MANUFACTURERS CORPORATION**

*CHICAGO 6 • 565 W. Washington Blvd.

MILWAUKEE 2
312 E. Wisconsin Ave.
DETROIT 2
15 Lawrence Ave.

*Local Stocks Available



*CLEVELAND 14
1231 Superior
Ave., N. E.

DAYTON 2
1315 Mutual Home
Building

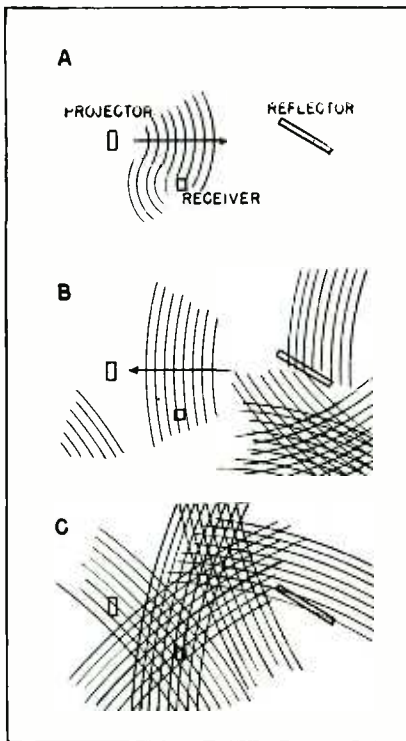

FIG. 1—Acoustic measurements incorporating the pulse technique are made only during interval (B) when only the desired reflected waves are at the receiver

ceiving systems and synchronizing the oscilloscope sweep circuit.

An initiating pulse acting on the oscillator control circuit creates a longer control pulse which actuates the oscillator. While on, the oscillator delivers a burst of power at its characteristic frequency. This burst, amplified in a conventional transmitting amplifier, is delivered to a transducer which then projects a sound pulse into the water.

After passing through the acoustic system, the wave packet is picked up by a hydrophone receiver, which feeds a signal into the receiver amplifier. A gate circuit is interposed between the output of this amplifier and the input of the oscilloscope. A delayed gate pulse is applied to the receiver gate circuit when the acoustic pattern in the tank has developed to the proper degree. The gate pulse allows the receiver to become operative only long enough to pass the desired section of the received signal.

It will be evident that full use has been made here of the pulse techniques used during the war in radar and sonar systems. From a practical point of view, phase and

wave shape observations which were out of the question in previous acoustic pulsing equipment using electronic switch tubes can now be made, because variable switching transients and lack of phase synchronization have been eliminated.

The detailed schematic circuit is shown in Fig. 3. Except for the pulsed oscillator,² which is somewhat unusual, each section is a conventional circuit with constants adjusted for this application. These circuits are given in standard texts³ and can be redesigned by well known methods^{3,4,5} to fit other applications.

With circuit constants shown in the schematic diagram, burst repetition rates of 60, 30, 20, 15, 12, and 10 per second are possible. The burst duration is adjustable from 1

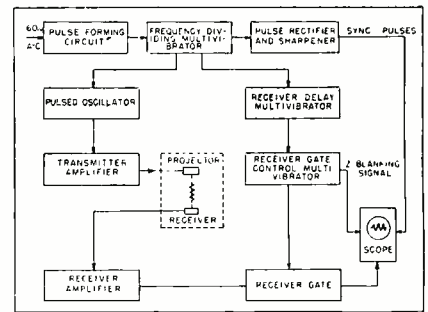

FIG. 2—Block diagram of acoustic pulse measurement equipment

to 90 milliseconds, while the receiver gate pass duration is variable between 0.1 to 9 milliseconds. Acoustic frequencies from 17 kc to 50 kc are available, and the receiver gate time delay may be varied from 1 to 90 milliseconds. Any of these

(continued on p 136)

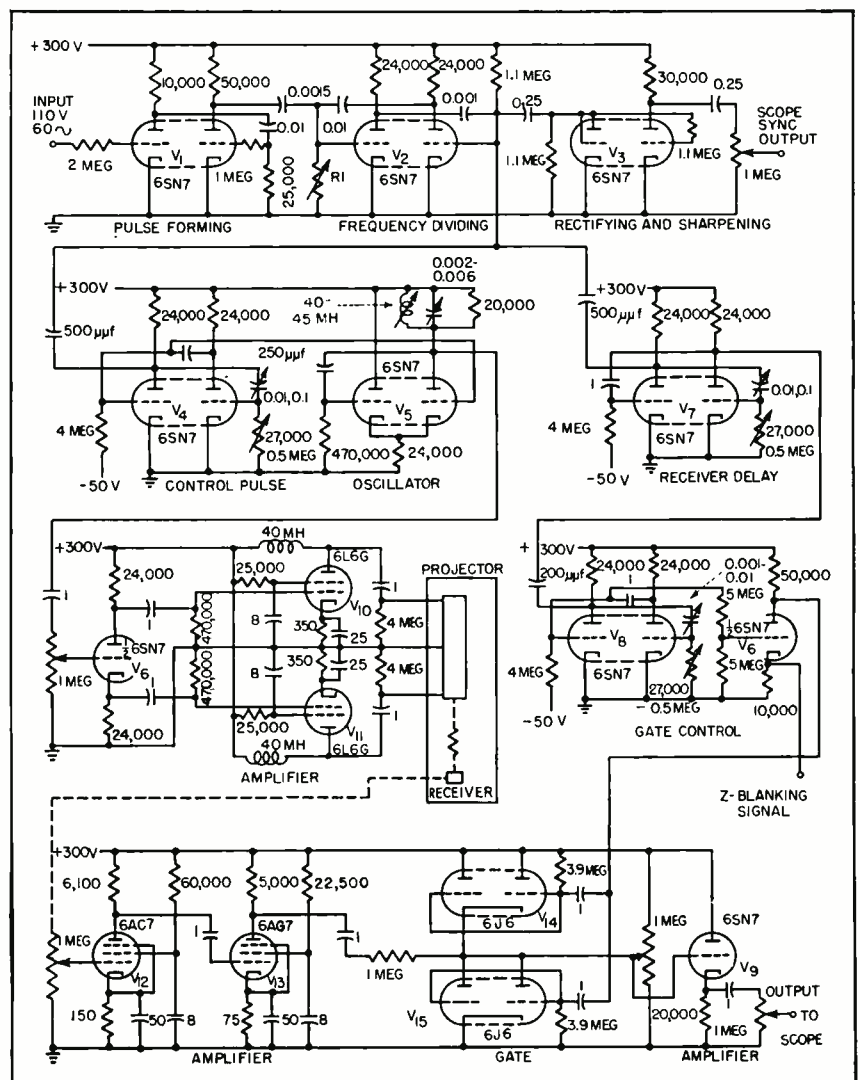
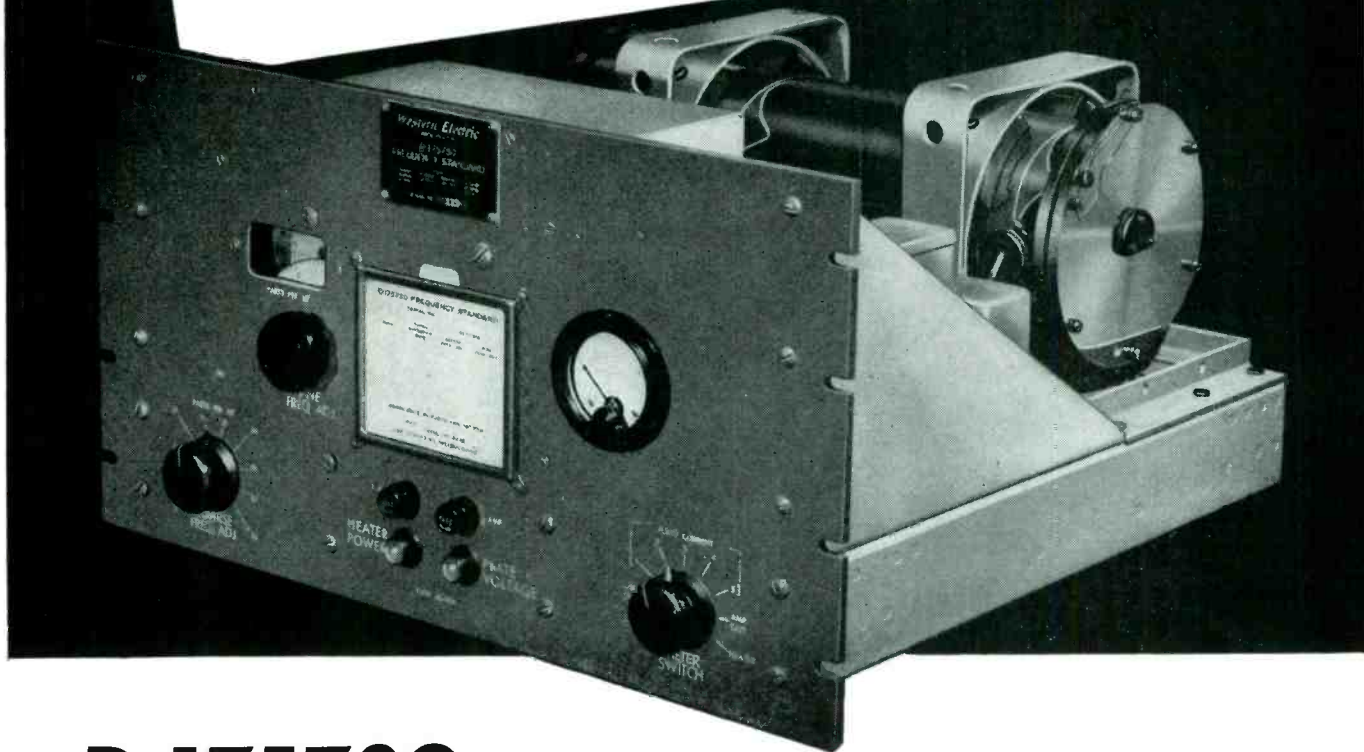

FIG. 3—Schematic diagram of acoustic measurement circuit using the pulse technique. Resistor R_1 is variable in steps of 0.75, 1.5, 2, 2.7, 4 and 5 megohms for selection of pulse repetition rates

Accurate to 1 part in 10^8



D-175730

Primary Frequency Standard

Here is a 100 kc frequency source of the highest precision—yet rugged enough to be used in semi-portable service.

The frequency of the Western Electric Primary Frequency Standard D-175730 is maintained to within one part in 10^8 , measured over a period of one day, regardless of moderate changes in ambient temperature, humidity and air pressure.

Heart of this high-precision instrument is a GT-cut crystal, suspended by wires inside an evacuated glass envelope. Crystal is cut and ground for

extremely low temperature coefficient (less than 10.5 parts per 10^8 per degree F) and is enclosed in an oven that maintains constant crystal temperature within 1/100 of a degree.

If you are making time-frequency measurements—or operating two or more independent systems in synchronism—you will want to investigate the Western Electric Primary Frequency Standard. For further information, call your nearest Graybar Representative, or write Graybar Electric Company, 420 Lexington Avenue, New York 17, N. Y.

Western Electric

—QUALITY COUNTS—



DISTRIBUTORS: IN THE U. S. A.—Graybar Electric Company. IN CANADA AND NEW FOUNDLAND—Northern Electric Co., Ltd.

THE ELECTRON ART

Edited by FRANK ROCKETT

Radio-Frequency Mass Spectrometer	124
Noise in Vacuum Phototubes at High Current Levels	126
Detecting Displacement	168
Reducing Hum in Pentodes	170
Survey of New Techniques	178

Radio-Frequency Mass Spectrometer

A NEW TYPE ELECTRONIC TUBE, which provides a greatly simplified and flexible mass spectrometer, has been designed by W. H. Bennett of the National Bureau of Standards. The new spectrometer provides

means of exploring the little-known fundamentals of negative atomic ions and a simple method for studying positive ions. The accompanying photograph shows the construction of a single-stage tube, which requires low direct biasing voltages and a radio-frequency voltage that can be varied from about 100 kc to 3 mc for its operation. In experiments with negative ions, a magnetic field of the order of 100 gauss parallel to the grids of the tube is also required.

Formation of Negative Ions

Development of the new tube was necessitated by attempts to investigate conditions leading to the formation of negative atomic ions of the heavier elements. Detecting, separating, identifying and measuring such ions is one of the neglected fields of research in pure physics. These negative ions, consisting of atoms with extra electrons, have very low energies of formation; their study has been difficult because of their rapid dissociation in very short distances, before they reach a measuring electrode.

Since their discovery about 40 years ago, negative ions have been detected for only a few elements, although theory indicates that many elements should have such ions. Previous experiments at NBS indicated that negative ions might exist in many familiar forms of electronic tubes, but that they would not be detected if the discharge path within the tube was longer than about an inch.

Operation of Spectrometer

The radio-frequency mass spectrometer tube consists of a cathode,

CURE FOR RESIDUAL RIPPLE

Ripple introduced into high-gain balanced low-frequency amplifiers from the alternating heater currents can be removed by demagnetizing the tubes. In setting up hundreds of biological amplifiers at the Burden Neurological Institute (England), it was observed that although ripple could be reduced in some cases by using tubes with screened heaters or operating the heaters at reduced voltage, ripple from the magnetic component of the heater current remained in some tubes. Inasmuch as selection of tubes was impractical, some method for removing this source of ripple was sought. The investigation showed that this residual magnetic source of ripple could be removed by demagnetizing the tubes in a decreasing a-c field. (Electronic Engineer, p 235, July 1948)

near which positive or negative ions are formed, several grids and a plate. If negative ions are to be studied, a small magnetic field is required to confine the electrons to the space inside the first grid to prevent formation of positive ions in other parts of the tube.

Ions arising at the cathode are accelerated through the first grid into the alternating field of the second grid, to which the r-f voltage is applied. Those ions that enter this field at the proper phase, and which have a mass and velocity related to the frequency of the field, pass through the second grid as the r-f potential changes polarity. Thus these ions are accelerated while traveling from the first to the third grid. A blocking potential, nearly equal to the maximum energy with which ions of the proper mass emerge from the r-f field, is applied to the fourth grid and the current to the plate is observed, thus indicating the rate at which ions of a particular type are being formed.

The method can be extended to two cascaded stages as shown in the following picture, thus obtaining a high order of mass resolution. In its more advanced form, this double-stage spectrometer can be used for measuring positive or negative ions. The equipment consists essentially of a multigridded tube in which the adjustable radio frequency is applied to two grids, one in each of the two stages, while all

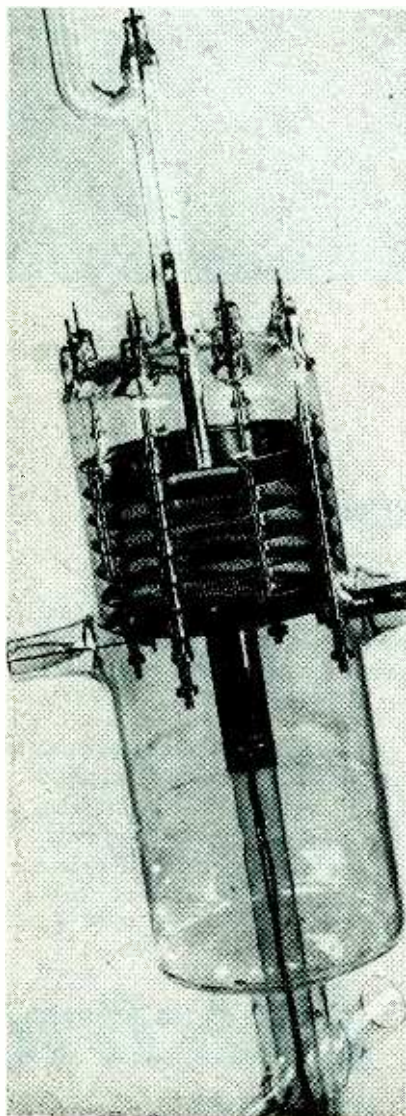

New electronic tube makes practical the investigation of negative ions and simplifies equipment for studying positive ions

MANY FEATURES IN ONE INSTRUMENT!

The Q-METER TYPE 160-A

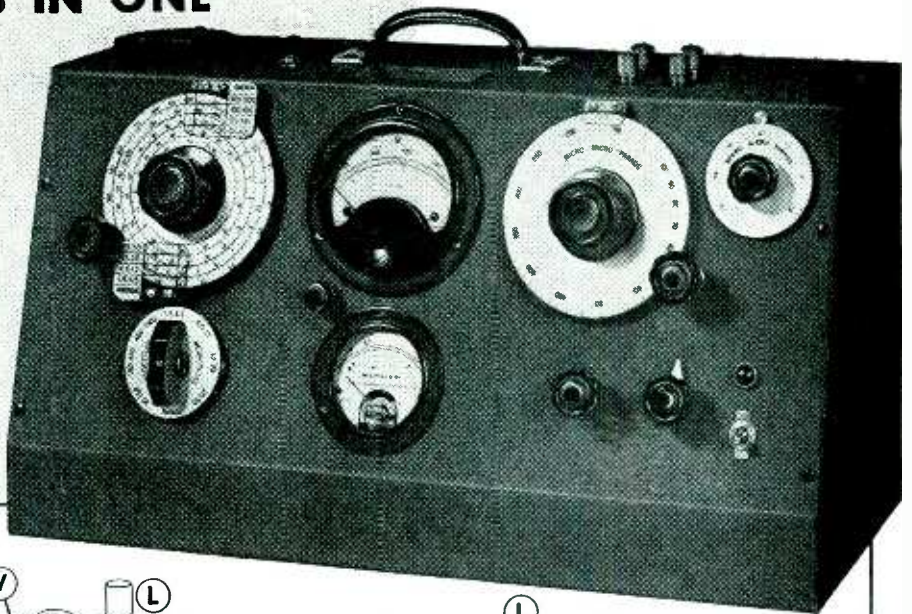

A dependable test and measuring instrument that should be included in your new equipment plans.

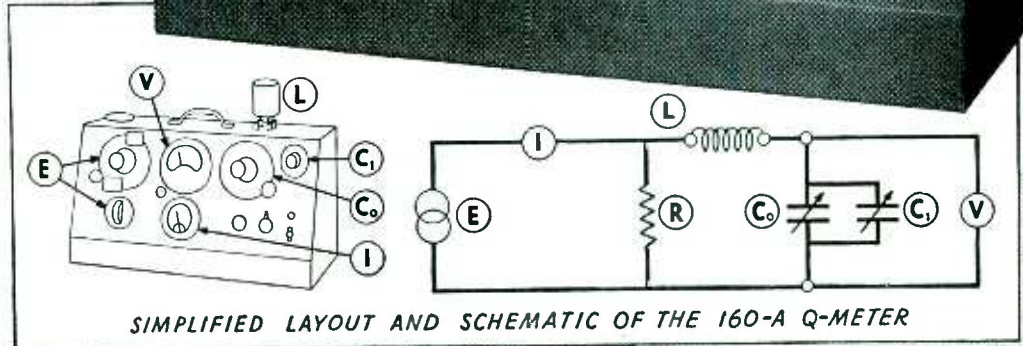

SIMPLIFIED LAYOUT AND SCHEMATIC OF THE 160-A Q-METER

For many years the Q-Meter has been an outstanding contribution to the field of radio frequency measuring equipment. It is an indispensable instrument to engineers, manufacturers, research laboratories and to the whole radio and electronics industry. Because of its simplicity and ease of operation, it replaces many costly pieces of apparatus with which the radio laboratory is customarily equipped. More than one radio engineer has told us that "The Q-Meter is the most valuable instrument that we have in our laboratory".

A FEW USES FOR THE 160-A Q-METER

- Q and inductance measurement of coils.
- Q and capacitance measurement of capacitors.
- Dielectric and power factor measurements of ceramics, plastics and other insulating materials.
- Measurement of circuit losses.
- Interelectrode capacitance measurements.
- Measurement of input impedance of vacuum tubes.
- Measurement of coefficient of coupling of R. F. Transformers.
- Measurement of transmission line characteristics.
- The measurement of frequency with negligible loading on circuit under test (50kc.—75 mc.).

Write for catalog "F" describing our complete line of electronic laboratory measuring equipment.

BOONTON RADIO
Corporation
BOONTON · N · J · U · S · A ·

THE BASIC METHOD OF MEASUREMENT EMPLOYED IN THE 160-A Q-METER

An 8 range R.F. oscillator (E) supplies a heavy current (I) to an extremely low resistance load (R), the value of which is accurately known. The calibrated voltage thus developed across the load resistance (R) is coupled to a series circuit consisting of the inductance under test (L) and a calibrated variable air capacitor (C₀), having a vernier section (C₁). When this series circuit is tuned to resonance by means of the capacitor (C₀ + C₁), the "Q" of the inductance under test is indicated directly by the vacuum tube voltmeter (V). Variations of this basic method of measurement are used to measure inductance, capacitance and resistance.

SPECIFICATIONS

Oscillator Frequency Range: 50 kc. to 75 mc. in 8 ranges.

Oscillator Frequency Accuracy: ± 1%, 50 kc. — 50 mc.

± 3%, 50 mc. — 75 mc.

Q-Measurement Range: Directly calibrated in Q, 20–250; "Multiply-Q-By" Meter (I) calibrated in tenths from x1 to x2, and also at x2.5; extending Q range to 625.

Q-Measurement Accuracy: Approximately 5% for direct reading measurement, for frequencies up to 30 mc. Accuracy less at higher frequencies.

Capacitance Calibration Range: Main capacitor section (C₀) 30–450 mmf accuracy 1% or 1 mmf whichever is greater. Vernier capacitor section (C₁) +3 mmf, zero, -3 mmf, calibrated in 0.1 mmf steps. Accuracy ± 0.1 mmf.



DESIGNERS AND MANUFACTURERS OF THE "Q" METER . . . QX-CHECKER . . . FREQUENCY MODULATED SIGNAL GENERATOR . . . BEAT FREQUENCY GENERATOR . . . AND OTHER DIRECT READING TEST INSTRUMENTS

the other electrodes are held at appropriate direct potentials. As in the single stage unit, the ion current is measured at the plate. The exacting requirements of negative-ion separation require the use of a small magnetic field produced with external coils, but no magnetic field is required if positive ions are being separated.

Because large electromagnets or tubes containing electrodes with elaborate systems of slits are not required in the r-f mass spectrometer, this new instrument should find wide application where its resolution is sufficient. One of the principal limitations upon the resolution possible with ordinary mass spectrometers using magnetic deflection of beams is the spread in energies of the ions at the source. The percentage spread can be reduced by increasing the voltage applied to the ions before they are magnetically resolved, but the extent to which they can be accelerated is limited by the magnetic field strength that can be produced within the tube.

In the r-f mass spectrometer, this difficulty is eliminated so that the voltage applied to the ions can be pushed easily to at least an additional order of magnitude. The frequencies that are required are then increased by an amount equal to the square root of the factor by which the voltage is increased. Increasing the voltage reduces the percentage spread of the measured mass line, which is due to the velocity spread in the ion source, by the same percentage that the accelerating voltage is increased.

The large number of grids (seven) in the double-stage spectrometer would be impractical if it were not that a knitted wire fabric, which has more than 95-percent open area and with which this type of tube can readily be constructed, is now available. The simplicity and low cost of the r-f mass spectrometer should make it attractive in those applications in which its special characteristics make it superior to other kinds of mass spectrometers. Although the full possibilities of the new tube have not yet been explored, preliminary experimentation with it suggests that it will have wide application.

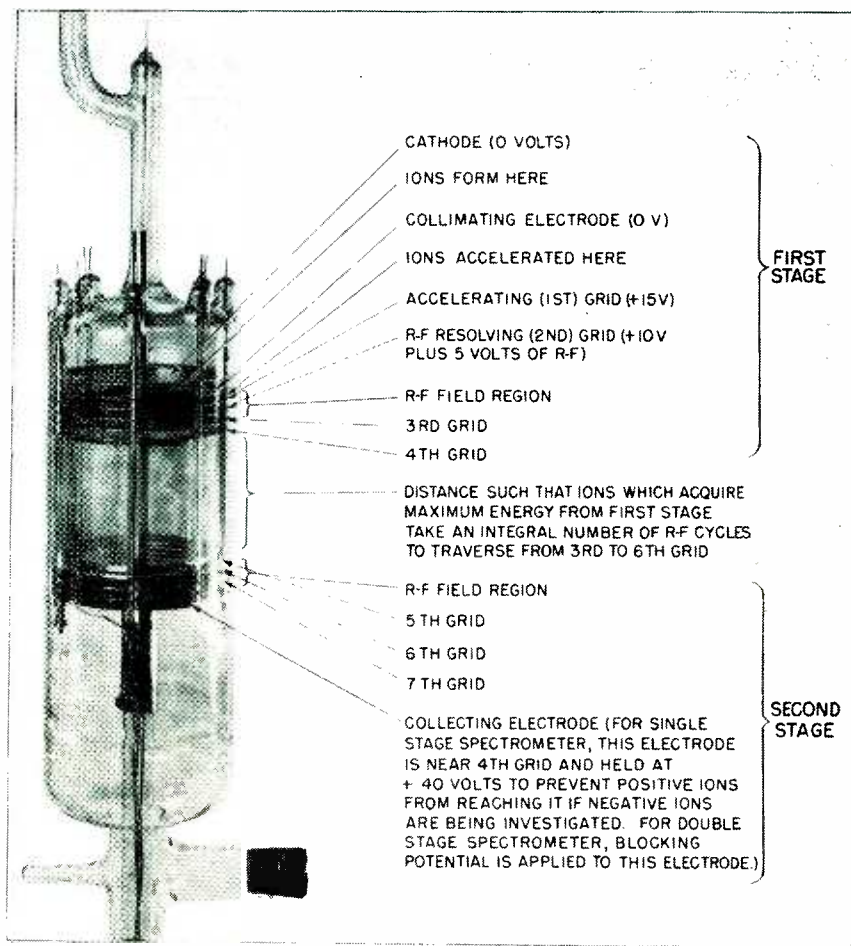

Radio-frequency fields in two-stage mass spectrometer separate ions by passing only those whose initial mass and velocity give them a transit time comparable to r-f period

Noise in Vacuum Phototubes at High Current Levels

BY R. F. MORRISON
National Bureau of Standards
Washington, D. C.

MEASUREMENTS of the output noise from phototubes were made and compared to the theoretical noise due solely to shot effect. The good agreement between measured and computed values indicates that, at cathode currents from as low as 50 microamperes to as high as 1.0 milliampere, shot effect is the only important source of noise.

Sources of Noise

The flow of electrons from cathode to anode of a phototube under steady illumination is not perfectly uniform. Although the average current is constant, there are small fluctuations due to the

random nature of photoelectric emission. These fluctuations produce noise that limits the percent modulation which may be used in optical systems having phototube detectors. Knowledge of the amount of noise generated in phototubes is essential to the design of precision optical equipment. Several investigators have measured shot effect noise at low frequencies, approximately 1,000 cps, with phototube currents of the order of a microampere or less^{1,2}.

The mean relative fluctuation δ in number of emitted electrons can be deduced from the theory of

(continued on p 162)

A MAGNET WIRE

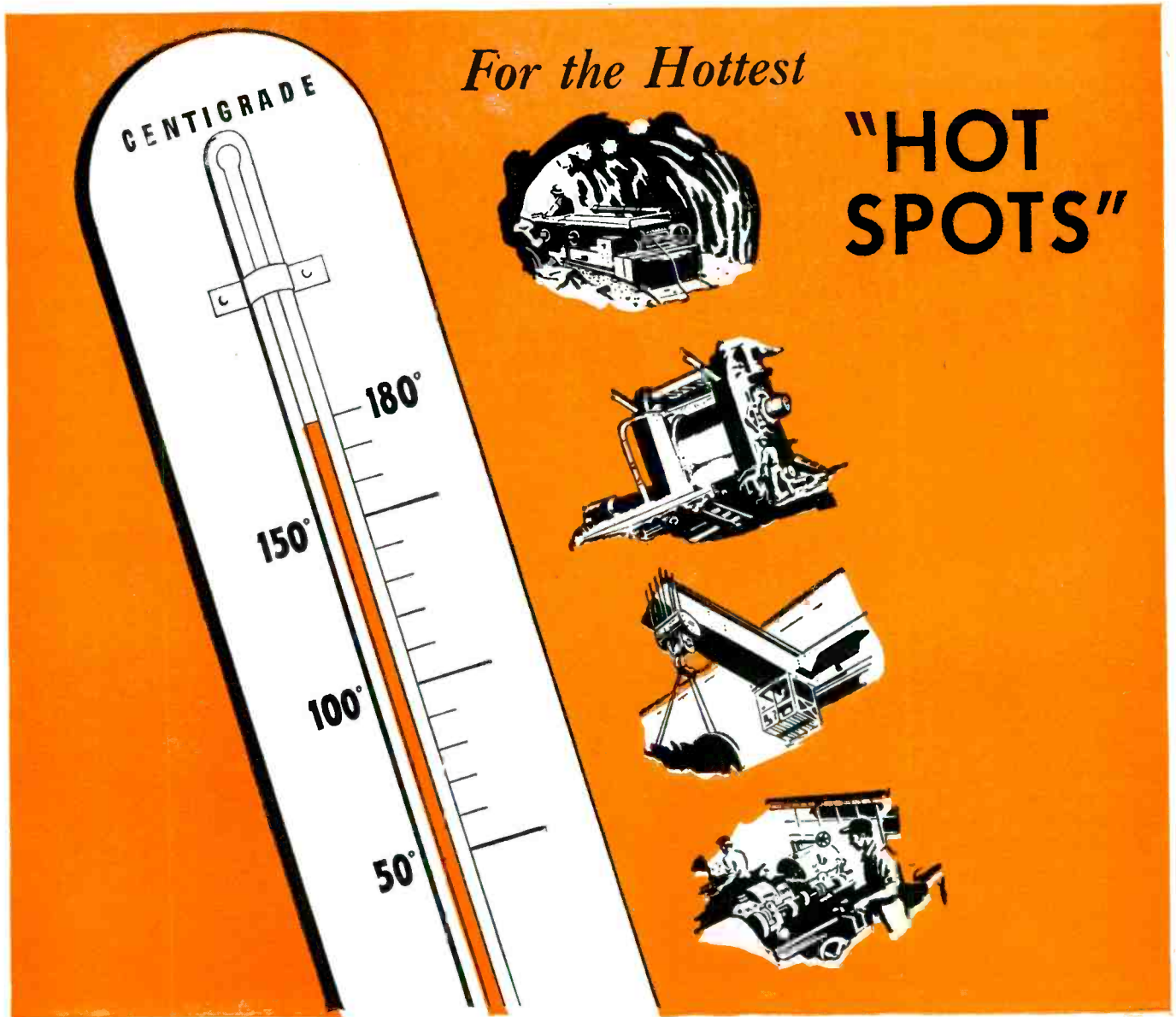

HOW CAN MAGNET WIRE, *even Silotex**, withstand continuous operation at extreme high temperatures?

The answer is in war-developed *silicones*, now brought to the magnet wire field by Anaconda in amazing glass insulated Silotex—bonded with *silicone varnish*. Such insulation qualifies for the new A. I. E. E. high-temperature rating of "Class H"... 180°... a 140° rise

in temperature over an ambient 40° C!

Even at operating temperatures around 180° C, here's what Silotex offers: Greater life expectancy, greater over-load protection, immunity to ambient temperature, greater moisture resistance, reduction in fire hazard. For complete information on the properties of Silotex, write to Anaconda Wire and Cable Company, 20 N. Wacker Drive, Chicago 6, Ill.

48444



Anaconda
SILICONE BONDED

SILOTEX

* *Magnet Wire*

®Reg. U. S. Pat. Off.

NEW PRODUCTS

Edited by A. A. McKENZIE

New equipment, components, tubes, testing apparatus and products closely allied to the electronics field. A review of catalogs, handbooks, technical bulletins and other manufacturers' literature

Subminiature Tubes

SONOTONE CORP., Elmsford, N. Y., announces a new line of T-2 sub-miniature filamentary type tubes. The line includes a pentode voltage amplifier and pentode power-output

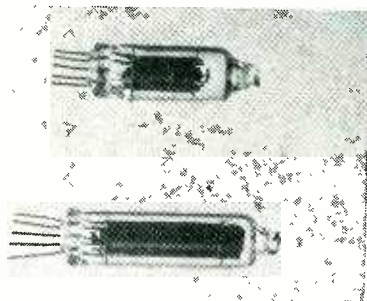

tube. Both types are produced in three filament current ratings: 20, 15, and 10 milliamperes. Normal filament voltage across the voltage amplifier is 0.6 volt; across the power amplifier, 1.2 volt. With battery supplies of about 20 v and a typical hearing-aid circuit, the amplifier has a voltage gain per stage of about 75. The power tube delivers 2 milliwatts with a battery drain of 10 milliwatts.

Beat-Frequency Oscillator

GENERAL RADIO Co., 275 Massachusetts Ave., Cambridge 39, Mass. Type 1304-A beat-frequency oscillator supersedes the older type 913-C. Although it is identical in

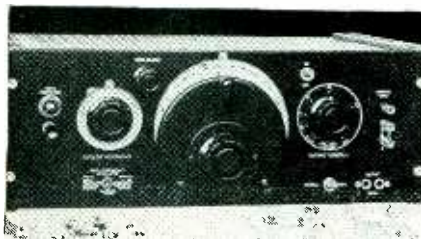

overall size and frequency range the new oscillator has greater accuracy, better stability, and lower distortion. Frequency range is 20 cycles to 20 kc with accuracy of \pm (1 percent + 0.5 cycle) after the dial zero has been set in terms of the a-c line frequency. Output impedance is 600 ohms; normal maximum output is 0.3 watt with total distortion of less than 0.25 percent over most of the range.

Television Equipment

TELEQUIP RADIO Co., 1901 South Washtenaw Ave., Chicago 8, Ill.

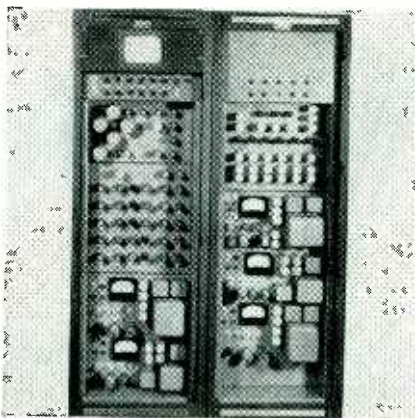

The television picture generator illustrated is representative of a line of equipment for studio rehearsal or broadcast use. The TMG-100A monoscope picture generator and distribution panel are also available.

Subminiature Battery

NATIONAL CARBON Co., 30 East 42nd St., New York 17, N. Y. A new hearing aid A battery with life

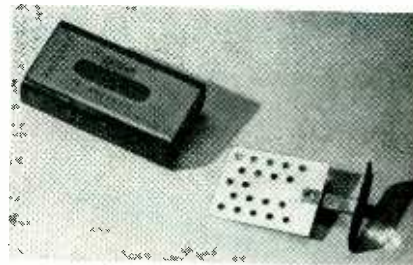

of 80 hours (4.25 ampere-hours under ASA test conditions) is only the size of a dual penlite-type battery. Zinc electrode is in the center and carbon strips on the outside of the plastic case act as depolarizers.

Sensitive D-C Scope

AMERICAN BRITISH TECHNOLOGY, Inc., 57 Park Ave., New York 16, N. Y., distributors for Furzehill Labs. Model 1684K is a new high-



sensitivity version of the Model D scope and has a gain of about 10,000 times. Sensitivity of the d-c amplifiers for both axes is 1 millivolt per inch. Frequency range up to 300 kc.

Step Attenuator

WEINSCHEL ENGINEERING Co., 123 William St., New York 7, N. Y. A new step attenuator can be used in the frequency range from 0 to 1,000 mc, or by heterodyne methods its

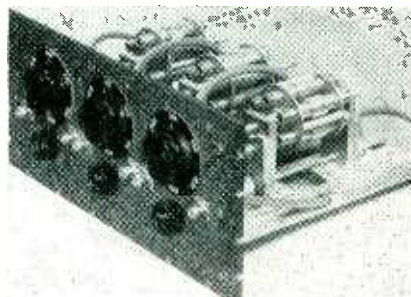

**COMPLETE
TV
EQUIPMENT**

*from camera chain
to transmitter*

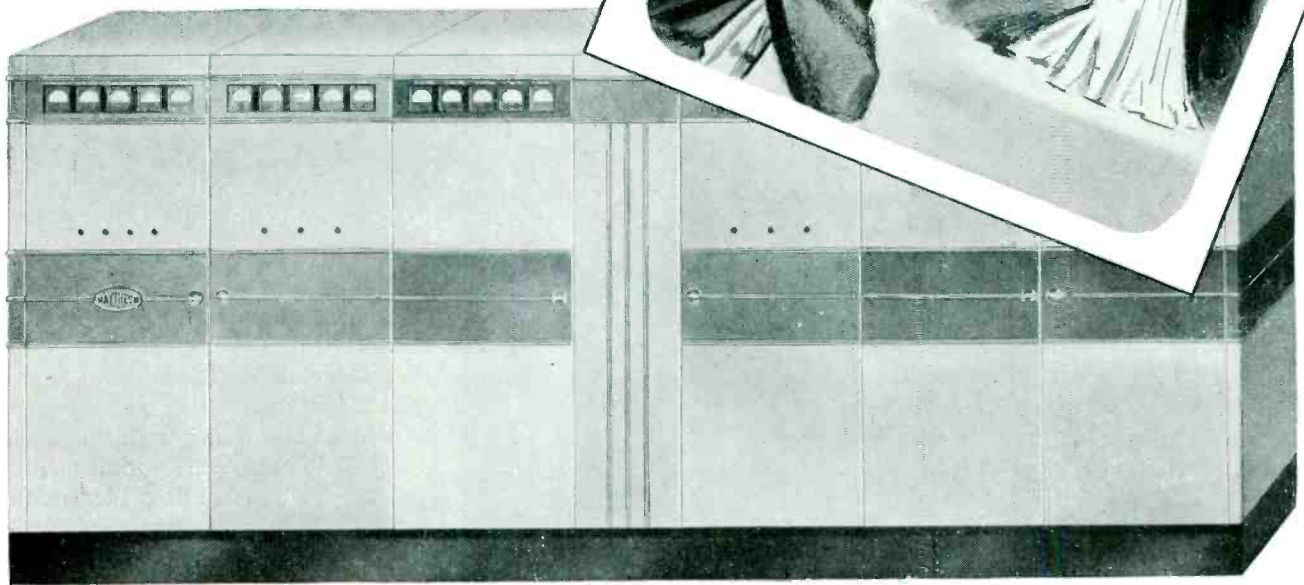

**LOOK TO RAYTHEON
FOR ALL YOUR NEEDS**

RAYTHEON is prepared to furnish complete equipment for television stations. Through this one dependable and reliable source of supply you can obtain any single item or an entire installation ranging from camera chains to antenna and associated equipment... including 50 watt microwave equipment for remote pickup, STL, or point-to-point relay. Raytheon stands ready to provide you with prompt and intelligent service at all times.



Excellence in Electronics



NEW ENGLAND

Albert Keleher, Jr.
Raytheon Manufacturing Co.
Waltham 54, Mass.
WA. 5-5860, Ex. 422

CHATTANOOGA, TENNESSEE

W. B. Taylor
Signal Mountain
8-2487

CHICAGO 6, ILLINOIS

Warren Cozzens
Ben Farmer
222 West Adams Street
Ran. 7457

DALLAS 8, TEXAS

Howard D. Crissey
414 East 10th Street
Yale 2-1904

NEW YORK 17, NEW YORK

Henry J. Geist
60 East 42nd Street
MU. 7-1550

SAN FRANCISCO, California

E. J. Rome
49 California Street
Sutter 1-0475

SEATTLE, WASHINGTON

Adrian VanSanten
135 Harvard North
Minor 3537

WASHINGTON 4, D. C.

Raytheon Manufacturing Co.
739 Munsey Building
Republic 5897

WILMINGTON, CALIFORNIA

J. L. Lovett
404 North Avalon Blvd., Terminal 4-1721

RAYTHEON MANUFACTURING COMPANY

Industrial and Commercial Electronic Equipment,
FM, AM and TV Broadcast Equipment, Tubes and Accessories
WALTHAM 54, MASSACHUSETTS

range can be effectively extended to 3,000 mc. It is useful for impedance measurements, taking antenna characteristics, calibrating voltmeters, and checking receiver gain. Attenuation is 0 to 60 db.

Electronic Counters

TECHNITROL ENGINEERING Co., INC., 3212 Market St., Philadelphia 4, Pa. The basic decade electronic

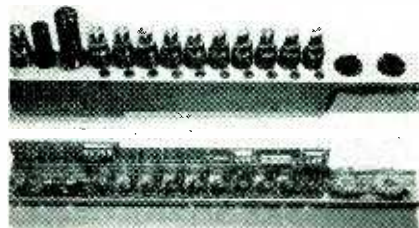

counter illustrated is combined with switching circuits for counting and timing circuits that involve speeds exceeding 150,000 counts per second. Predetermined counting, measurement of elapsed time to less than 7 microseconds, and various other features are included.

Loudspeaker

KLIPSCH AND ASSOCIATES, Hope, Arkansas. The new Style 5 high-fidelity loudspeaker is complete



with cabinet. Each loudspeaker comprises a high-frequency tweeter and new K-3-C woofer with response down to nearly 35 cycles. Equipment is distributed through Brociner Electronics Lab., 1546 Second Ave., New York 28, N. Y.

Tone Arm

WEBSTER ELECTRIC Co., Racine, Wisconsin, has announced the

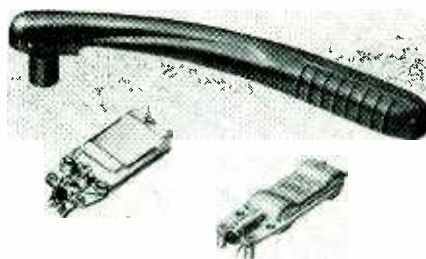

Featheride tone arm and two new crystal cartridges for reproduction of long-playing microgroove records. The unit is balanced to maintain 7-gram tracking pressure. Model F12 cartridge is for long-playing records only, and model F11 plays either microgroove or standard records.

Television Test Device

RADIO CORP. OF AMERICA, Camden, N. J. Type WA-21A video sweep generator, when used with suitable



detector and oscilloscope, facilitates rapid testing of television i-f frequency systems with visual observation of the frequency response characteristic through a range of 100 kc to 10 mc.

Microgroove Cartridge

GENERAL ELECTRIC Co., Syracuse, N. Y. A new variable reluctance

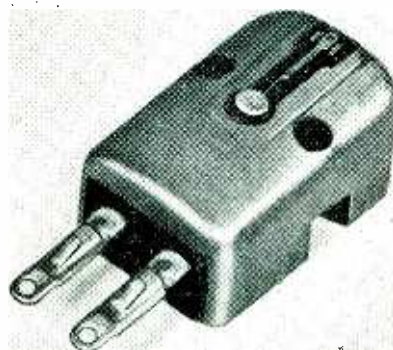

cartridge designed for long-playing microgroove records has a sapphire stylus, 1 mil in diameter. One-third smaller than previous models, its shape makes it adaptable to various tone arms and gives more clearance for record changers.

F-M Radio Link

FEDERAL TELEPHONE AND RADIO CORP., Clifton, N. J. The FTL-11-A is a high-fidelity studio-to-transmitter radio link for f-m broadcasting. It operates in the 940 to 952-mc

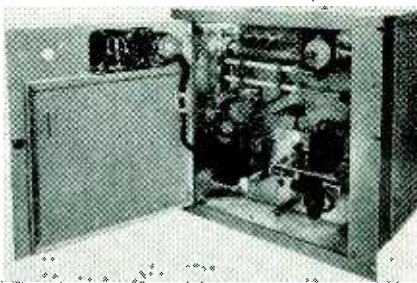

band and permits program transmission up to line-of-sight ranges of approximately 30 miles. Distortion is less than 0.5 percent between 50 and 15,000 cycles, with the noise level 65 db below 100-percent modulation. The transmitter illustrated here has a power output of about 3 watts.

Subminiature 6AK5

RAYTHEON MFG. Co., Newton, Mass. The new subminiature type CK-5702/CK605CX tube is now avail-



able. Aside from a small difference in heater current, the tube is electrically interchangeable with the type 6AK5. Sockets for the new tube are also available.

Tuned-Ribbon Reproducers

AUDAK Co., 500 Fifth Ave., New York 18, N. Y. The LM series of Tuned-Ribbon reproducers was designed for use with long-playing records. They operate with a point

(Continued on p 182)

FOR FINER ALL-WEATHER RECORDING



Now **audiogram*** lacquer provides permanent resistance to humidity

Excessive humidity has long been one of the industry's major problems—both to the manufacturer and to the recordist. Humid conditions in factories have frequently held up production and caused excessive spoilage. Also, discs which have absorbed too much moisture make poor recordings. The noise level increases progressively while recording and the cut gets greyer and greyer.

Air conditioning has been tried by several producers, but this does not prevent moisture absorption during transportation and storage. The real solution lies in the formulation of a lacquer which will provide permanent resistance to humidity. This has now been successfully accomplished by our research laboratory. Here are the facts:

1. THE IMPROVED AUDIODISC FORMULATION has eliminated all production difficulties due to excessive humidity. During the past summer no trouble was encountered, even with humidity as high as 90%.

2. COUNTLESS TESTS in our "weather room" have proved the new AUDIODISCS to be remarkably resistant to moisture absorption. Discs subjected to a temperature of 90° at 80% to 90% humidity for many weeks show no increase in noise level while recording. Ordinary discs, under the same conditions, show a noise level increase of from 15 to 25 db. The most conclusive proof of all, however, has come from the field—for during the past summer, one of the most humid on record, our customers have reported no difficulties in recording or reproduction due to humid conditions.

3. THIS "WEATHER-PROOF" FEATURE has been achieved without any basic change in our lacquer formulation. Recordists will therefore continue to note the outstanding qualities in recording, playback and processing which have made for AUDIODISC leadership.

This improved humidity-resistant lacquer is now used on all AUDIODISCS. It is your assurance of finer, all-weather recording—with the same consistent, uniform quality which has characterized AUDIODISCS for a decade.

*Reg. U. S. Pat. Off.

Audiograms are manufactured in the U.S.A. under exclusive license from PYRAL, S.A.R.L., Paris.

Audio Devices, Inc., 444 Madison Ave., N.Y.C.

EXPORT DEPT: ROCKE INTERNATIONAL, 13 EAST 40TH STREET, NEW YORK 16, N. Y.



they speak for themselves **audiograms**

NEWS OF THE INDUSTRY

Edited by JOHN MARKUS

Radio Parts Show; IRE fellowships announced; midwest television networks; National Electronics Conference program

Television Application Freeze Announced by FCC

RECENT ACTION by the FCC temporarily halted any further authorization of new television stations. Chairman Wayne Coy announced that the freeze would remain in effect long enough for the Commission to decide whether certain changes should be made in engineering standards for the avoidance of interference between television sta-

tions in adjacent cities. This investigation would probably take about six months.

The freeze order applies only to stations for which applications are pending. Stations previously authorized, including the thirty-seven now on the air and the eighty-six now under construction, are not affected.

Coolidge Lab Dedicated

GROWING DEMAND for specialized industrial and medical applications for x-ray led to the foundation of the world's largest x-ray development laboratory, by General Electric X-Ray Corp. at Milwaukee,

Wisconsin. The \$750,000 research center will be known as Coolidge Laboratory, in honor of William D. Coolidge, x-ray pioneer and director emeritus of the GE Research Lab, Schenectady, N. Y. Dedication

ceremonies, attended by 200 radiologists, 1,100 employees, and 200 industrial leaders, physicists and research scientists, were highlighted by the addresses of Charles E. Wilson, president of General Electric, and Dr. William D. Coolidge, the guest of honor.

Since GE's expansion program began a year ago, seven major pieces of equipment have been developed by the Coolidge Laboratory: the Cardioscribe, a new direct-writing electrocardiograph that eliminates developing a film to read the heart's action; a direct-recording x-ray diffraction machine, which opens broad fields for the application of diffraction and facilitates analysis of unknown materials; the Maximar 100, a 100,000-volt machine designed especially for treating skin diseases; the Maxiscope 500, a new type of robot x-ray apparatus equipped for high-voltage radiography to provide better x-rays of heavy body sections; a new type Inductotherm, not yet ready for announcement; a special fluoroscope used by shoe manufacturers to find unwanted nails in shoes; and a new line of x-ray film illuminators using circular fluorescent lamps.

New IRE Section

OVER FORTY PEOPLE attended a recent organizational meeting of the IRE, held in Omaha, Nebraska, and signed a petition asking the national board of directors of IRE to form an Omaha-Lincoln Section. Papers were read, a collection was taken up to help finance the activity, and temporary officers were elected.

The meeting was presided over by George Hixenbaugh, chairman of the Cedar Rapids Section. An address outlining the place of the IRE in the local situation was given by T. A. Hunter, regional director. John A. Green, secretary-treasurer of Region 5, assisted with the organizational activity for the new section.

Rochester Fall Meeting

TENTATIVE PROGRAM of the Rochester Fall Meeting of members of the IRE and RMA Engineering Department, to be held at the Sheraton

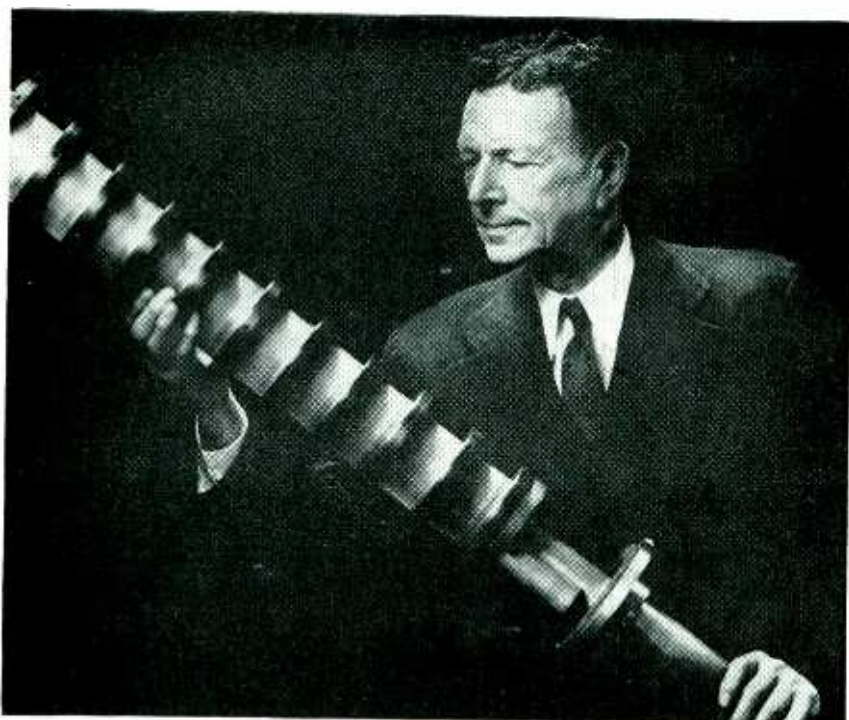

William D. Coolidge, father of modern x-ray tube, examines a million-volt x-ray tube

UHF EQUIPMENT

DEVELOPED • DESIGNED • PRODUCED

1. DEVELOPMENT . . . from concept of idea to working model
2. DESIGN by thoroughly experienced UHF engineers
3. MANUFACTURE . . . using methods especially suited to UHF work

Specialized UHF knowledge, experience and shop practice enable Lavoie Laboratories to handle every phase of electronic production efficiently and economically.

Precision work and low unit cost are based on these factors developed through years of practical specialization in this field.

• • • LAVOIE PRODUCTS: Frequency Meters—Frequency Standards—Receivers—Transmitters—Antennas and Mounts.

Detailed information and estimates of LAVOIE service are available promptly without cost or obligation.



Lavoie Laboratories

RADIO ENGINEERS AND MANUFACTURERS
MORGANVILLE, N. J.

Specialists in the Development and Manufacture of UHF Equipment

Hotel, Rochester, N. Y., November 8, 9 and 10, 1948, is as follows:

Monday, Nov. 8

9:30 A. M.—Technical Session—B. E. Shackelford presiding:
A Television Station Selector Using Die Stamped Inductances, by A. D. Sobel of A. W. Franklin Mfg. Corp.
A discussion of Image Sharpness in Photography and Television, by O. H. Schade of RCA.
Application of Subminiature Tubes, by R. K. McClintock of Sylvania.
2:00 P. M.—Technical Session—D. B. Smith presiding:
The Transitrol, an Experimental AFC Tube, by J. Kurshan of RCA Laboratories.
A New Low-Noise, Low-Microphonic Miniature Tube, by C. R. Knight and A. P. Haase of GE.
4:00 P. M.—Committee Meetings
8:15 P. M.—General Session—E. F. Carter presiding:
What's When in America, by Kenneth W. Jarvis, consulting engineer.
9:15 P. M.—Stag Party, courtesy of American Lava Corp.

Tuesday, Nov. 9

9:00 A. M.—Technical Session—S. L. Bailey, presiding:
Report of RMA Safety Committee, by William Vassar of Emerson.
Developments in Germanium Crystals, by Stuart T. Martin and Harold Heins of Sylvania.
A Television Distribution System for Laboratory Use, by Joseph Fisher of Philco.
2:00 P. M.—Technical Session—D. D. Israel presiding:
A Direct-Coupled Video and AGC System for Television Receivers, by H. R. Shaw of Colonial Radio Corp.
A Pulse-Cross Generator for Television Receiver Production, by R. P. Burr of Hazeltine.
4:00 P. M.—Committee Meetings
6:30 P. M.—Stag Banquet—B. DeForest Bayly, toastmaster

Wednesday, Nov. 10

9:30 A. M.—Technical Session—O. L. Angevine, Jr. presiding:
Lightweight Pickup Design for Microgroove Record Playing, by B. P. Haines, Elmo Voegtlin, C. D. O'Neill and R. S. Cranmer of Philco.
Symposium—What Constitutes High Fidelity, by Harvey P. Fletcher of Bell Telephone Laboratories, John K. Hilliard of Aitec Lansing Corp. and C. J. LeBel, consultant.
High-Quality Audio System for Radio Receivers, by R. S. Anderson and B. E. Atwood of Stromberg-Carlson Co.
2:00 P. M.—Technical Session—K. J. Gardner presiding:
Front Ends of Television Receivers, by J. O. Silvey of GE.
A Picture-And-Sound-Modulated Generator for Television Receiver Production, by W. R. Stone of Hazeltine.
4:00 P. M.—Committee Meetings
8:00 P. M.—Photographic Session—A. L. Schoen presiding.

Audio Engineers Compare Loudspeakers

A RECENT MEETING of the San Francisco Section of Audio Engineering Society featured a listening test of twenty different commercial loudspeakers and a demonstration of a new tweeter-tweeter speaker. Groups of high-fidelity speakers were cross-compared, driven from the output of a pair of push-pull 211's operating essentially as a zero-impedance source. Audio was derived from an Ampex tape recorder.

The session concluded with a description and demonstration of a new h-f speaker developed by Bob Smith and Water Selsted, San Fran-

MEETINGS

- OCT. 25-29: 64th semiannual convention, Society of Motion Picture Engineers, Hotel Statler, Washington, D. C.
- OCT. 27-28: Annual Convention, Society for Non-Destructive Testing, Hotel Adelphia, Philadelphia.
- Nov. 4-6: National Electronics Conference, Edgewater Beach Hotel, Chicago.
- Nov. 8-10: Twentieth Rochester Fall Meeting of members of IRE and RMA Engineering Dept., Sheraton Hotel, Rochester, N. Y.
- Nov. 29-DEC. 4: 18th National Exposition of Power and Mechanical Engineering, Grand Central Palace, New York.
- DEC. 10-11: Southwestern IRE Conference, Baker Hotel, Dallas, Texas.
- JAN. 10-12: Symposium on high-frequency measurements, held by Instruments and Measurements Committee jointly with the IRE and National Bureau of Standards, at Washington, D. C.
- APRIL 11-15: Sixth Western Metal Congress and Exposition, Shrine Auditorium, Los Angeles, Calif.
- MAY 16-20: Radio Parts Industry Trade Show and RMA Silver Anniversary Convention, Hotel Stevens, Chicago.

cisco audio engineers. The new speaker serves the range from 5,000 to 20,000 cps, operating above an ordinary tweeter, and is essentially nondirectional in both horizontal and vertical planes. It features a moving system of only 142 milligrams.

Navy Training by Television

EVALUATION and test of television as a vehicle for mass training of military personnel with a minimum of instructors is now under way at the Navy's Special Devices Center near Port Washington, Long Island. Weekly television lectures on naval science subjects are being telecast

eight miles to classrooms at the Merchant Marine Academy, Kings Point, N. Y., where one-fifth of the third-year class will be taught two subjects by television. Other students will receive standard instruction, and results will be evaluated by the Psychology Department of Fordham University.

Plans call for a tryout of network television training before the end of the year, with lectures going out from Special Devices Center over existing and new coaxial lines and microwave relay facilities to Naval Air Reserve Stations at Squantum, Floyd Bennett, Willow Grove and Anacostia. In all these tests, tele-

(continued on p 212)



Newly-elected officers of the San Francisco Section of Audio Engineering Society are, left to right: Myron Stolaroff, Ampex Electric Corp.; Jack Mullen, Bing Crosby Enterprises; Harold Lindsay and Frank Lennart, Ampex; Don E. Lincoln, Audiophone; I. R. Ganic, Audiophone (chairman); Walter T. Selsted, Pacific Broadcasting; Dick Beck, C. C. Brown and Ross H. Snyder, KJBS-FM

HEINEMANN

MAGNETIC CIRCUIT BREAKERS

are

*fully
electro
magnetic*

Therefore they carry up to full rated current under all conditions.

They are manufactured with instantaneous trip or time delay.

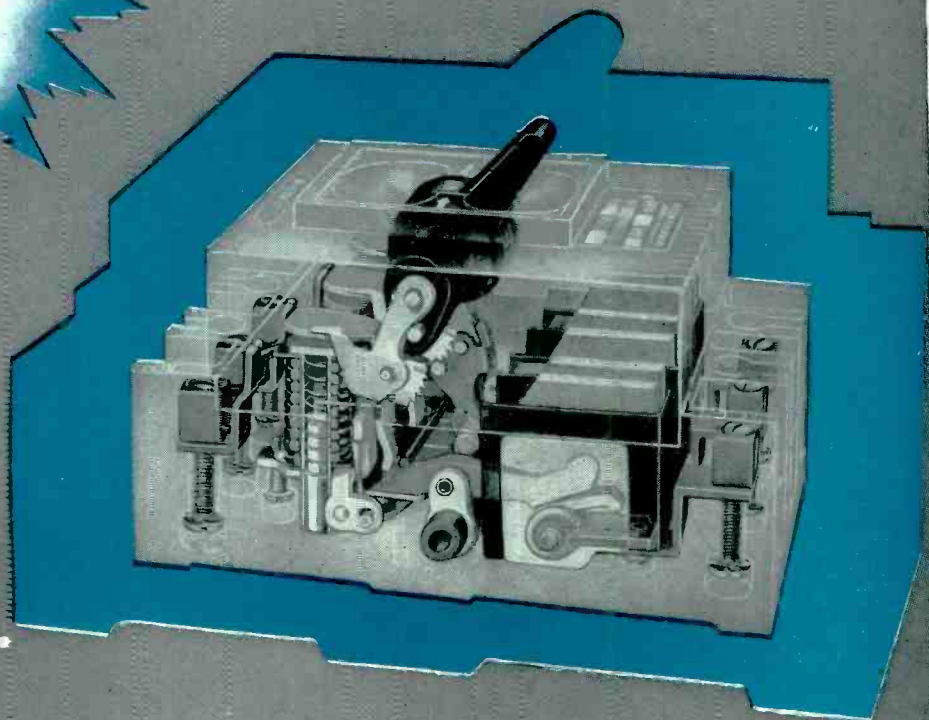

Because they are entirely electro-magnetic in action and do not depend on any thermal unit, HEINEMANN CIRCUIT BREAKERS will not trip before the current reaches the trip point specified. Whatever the surrounding temperature, the breaker will trip only on a load in excess of its rating.



HEINEMANN ELECTRIC COMPANY

97 PLUM ST.

TRENTON, NEW JERSEY

A lot of speaker in a little space



Western Electric 755A

TRY listening to the 755A first... then look at its size! You'll be amazed that so much performance can be packed into so little space.

Covering the frequency range from 70 to 13,000 cycles, the 755A gives brilliant tonal quality, faithful reproduction. Its 8-watt continuous capacity is ample for the general run of applications. And you get all this in a speaker only 8³/₈" in diameter—only 4³/₄ pounds in weight!

Use the 755A in broadcast stations, wired music, program and sound distribution systems, home radios and record players.

You can get 755A's from stock in quantity. Call your nearest Graybar Representative—or write to Graybar Electric Co., 420 Lexington Ave., New York 17, N. Y.

—QUALITY COUNTS—



DISTRIBUTORS: IN THE U. S. A.
—Graybar Electric Company. IN
CANADA AND NEWFOUNDLAND
—Northern Electric Company, Ltd.

TUBES AT WORK (continued from p 122)

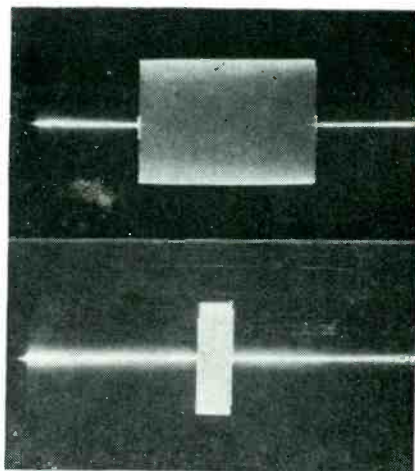

FIG. 4—Long exposure oscillograms showing signal pulse and gated response

parameters may be adjusted independently.

This circuit is sufficiently stable for close comparison of amplitudes, wave shapes and phase angles. Oscillator frequency drift is small enough to permit accurate measurements extending over 15 minutes or more. Operation of the receiver gate can be adjusted within a few microseconds. Figure 4 illustrates the quality of the transmitted wave packet and the gated receiver signal.

This work was supported in part by the Navy Department, Bureau of Ships, under Contract NObs-25391, Task No. 1.

REFERENCES

- (1) E. L. Carstensen, Self-Reciprocity Calibration of Electroacoustic Transducers, *J. Acous. Soc. Am.* 19, p 961, 1947.
- (2) F. Butler, Cathode-Coupled Oscillator, *Wireless Engineer*, 21, p 521, Nov. 1944.
- (3) M.I.T. Radar School Staff, "Principles of Radar", Second Edition, McGraw-Hill Book Company, Inc., New York, 1946.
- (4) M. V. Kiebert and A. F. Inglis, Multivibrator Circuits, *Proc IRE*, 33, p 534, Aug., 1945.
- (5) B. E. Phelps, Dual-Triode Trigger Circuits, *ELECTRONICS* 18, p 110, June, 1945.
- (6) E. R. Shenk, Multivibrator; Applied Theory and Design, *ELECTRONICS* 17, p 136, Jan., Feb., and Mar., 1944.

Electronic Fuse

OCCASIONALLY situations arise in which it may be necessary to fuse a circuit when the current passing through the fuse does not exceed the normal current. A circuit which provides heat control by turning off and on a heating element may provide just such a situation. In case of failure of the control mechanism or of the contactor which opens and closes the

**FOR RF HEATING—
BETTER PERFORMANCE
LONGER LIFE**

ML-5668

(REPLACES TYPE 892 FOR ELECTRONIC HEATING)

AND UNIQUE MACHLETT AUTOMATIC SEAL WATER JACKET*

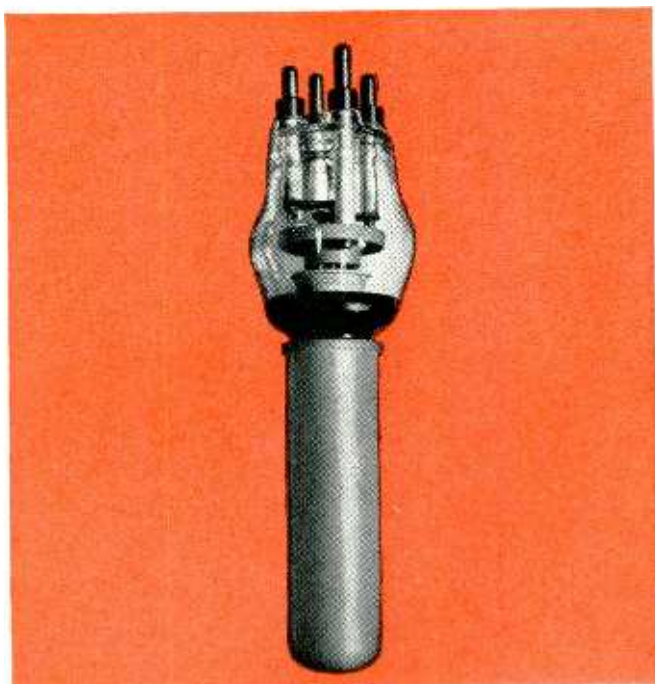

ML-5668—Water-cooled RF Heating Triode. With Machlett Automatic Seal Water Jacket is directly interchangeable with Type 892. Max. Input—28 kw. Max. Plate Dissipation—20 kw. For equivalent anode dissipation requires less than ½ water flow needed by the 892.

*Pat. applied for



MACHLETT AUTOMATIC SEAL WATER JACKET.* No tools needed to open and close this new jacket. No worry about tube breakage or water leakage. Jacket cannot be opened unless water pressure is off, nor closed unless tube is properly seated. Your hand opens and closes a perfectly safe seal with just a single twist.

THE new Machlett ML-5668 is of special and direct interest to every operator of electronic heating equipment using the 892 type of tube. The ML-5668, in combination with the Machlett Automatic Seal Water Jacket, is directly interchangeable with the 892 and its jacket, and, since it is designed specifically for this type of service, will provide greater effectiveness and increased economy on both induction and dielectric heating applications. RF heating requires the very best in tube design, construction, and processing, and the ML-5668, with its extra-heavy and uniquely-processed anode, its mechanically-sturdier grid, cathode and terminal construction, truly meets the need. This tube, and those who use it, benefit fully from Machlett's advanced techniques of design and manufacture.

For better, more consistent performance—for lower operating costs—for longer tube life—replace the 892 with the ML-5668.

* * *

The advantages offered by ML-5668 are also available to manufacturers and users of equipment employing other communication-type tubes, such as the 889A and 880, through the new Machlett Types ML-5604, ML-5619, ML-5666 and ML-5658. These RF heating tubes were designed, built and rated for electronic heating service, without compromise with the needs of other applications. For the complete story of the improved performance and lower costs offered by these tubes, write Machlett Laboratories, Inc., Springdale, Connecticut.



Over 50 Years
of Electron Tube Experience

M A C H L E T T L A B O R A T O R I E S , I N C .
Springdale, Connecticut

Sigma RELAYS

ARE USED IN
Western Electric
POWER LINE
CARRIER TELEPHONE SYSTEM

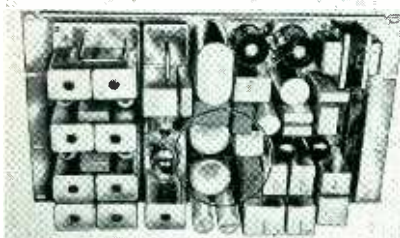
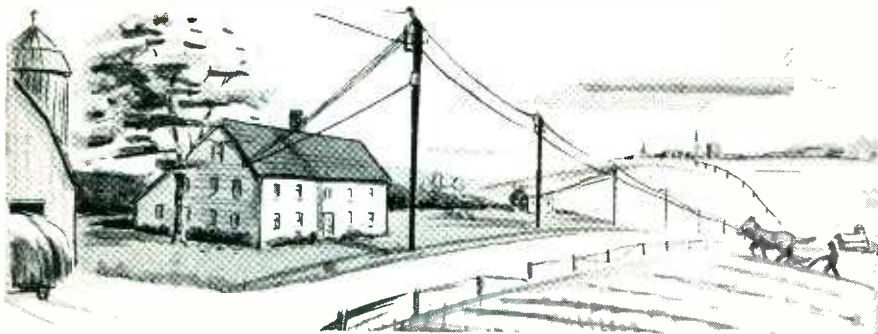

Common Carrier Terminal Chassis

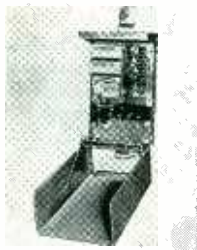

Subscriber Coupling Unit

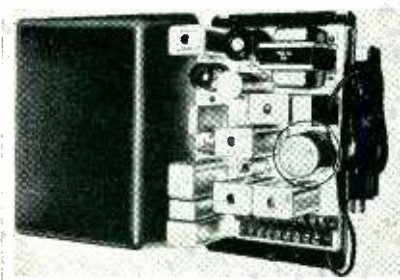

Subscriber Terminal Equipment

The Western Electric M1 Power Line Carrier Telephone System permits telephone service in thousands of farm houses having electric power service but no telephone wire line connections. It will help raise living standards in many rural areas.

Sigma Relays are used for three functions in this equipment, two of which are unusually exacting. By careful cooperative study of each application Sigma was able to work out solutions using highly refined but none the less conventional sensitive relays of standard Sigma design — available at comparatively low cost.

From vending machines to V-Bombs specialized relay design plus facility at solving problems involving circuit, relay and function enable Sigma to render valuable service.

SIGMA RELAY TYPES

A.C. - D.C. - POLAR
SENSITIVE - PRECISION - KEYING
SINGLE OR MULTIPLE CIRCUIT
From 68¢ to \$25.00 each!



Sigma Instruments, Inc.
Sensitive RELAYS

62 CEYLON ST., BOSTON 21, MASS.

TUBES AT WORK

(continued)

circuit, the heating element will continue to raise the temperature above that desired, and may constitute a fire hazard.

An ordinary fuse will not provide protection against this hazard, since the current in the heating element has not changed appreciably from its normal value. Temperature sensitive devices may be too expensive or may not be desirable for other reasons.

In one electric blanket, a feeler wire is placed through the blanket, that responds to temperature change, and this response serves as the basis for a control voltage. The control opens or closes a contactor to maintain the proper heating in the blanket. If the contactor fails to open at the proper time, some means must be provided to open the circuit to prevent excessive overheating.

Both the desired protection and comfort are obtained with a thyatron. The current carried by the tube when it is conducting is limited by the impedance in series with the tube, which need not necessarily affect the operation of the circuit to be fused.

When two cathode connections are provided in a thyatron tube, one side of the voltage supply can be connected to one of the cathode connections, and the other cathode terminal connected to the circuit, thereby making a lead inside the tube actually a part of the supply line to the circuit. The anode of the thyatron is connected to the other side of the supply voltage, the tube normally not conducting current and therefore not affecting the operation of the circuit.

The grid circuit of the thyatron is connected to the control circuit in such a way that as a fault occurs which would cause overheating of the element, the negative grid voltage on the thyatron is reduced to a point where the tube conducts. The tube current will be far in excess of the circuit current and will be sufficient to burn out one of the cathode connections, thereby opening the supply line to the heating element. Like any other fuse, the tube is rendered useless and must be replaced when the circuit fault has been corrected.

The GL-1367, a General Electric

Photomicrographics are only part of the story...

EVERY KNOWN TEST QUALIFIES WILBUR B. DRIVER ALLOYS FOR SUPERIOR INSTRUMENTATION!

Photomicrographic checking of grain size and quality of metals is only one of the exhaustive tests which Wilbur B. Driver resistance alloys are subjected to throughout production. There are many others including ASTM life, tensile strength, yield point, hardness, micrometer and thorough testing for resistance. These constant checks plus industry-old experience, are the reasons you can depend on all Wilbur B. Driver alloys to perform as specified. The alloys listed are so produced, and are especially recommended for instrumentation.

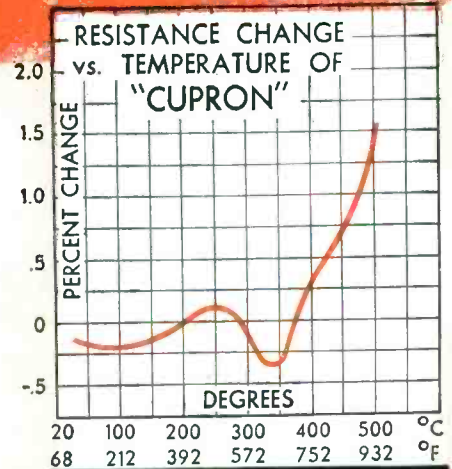

CUPRON:
FOR CONTROLS, RHEOSTATS, ETC. LOW TEMPERATURE COEFFICIENT OVER A WIDE RANGE OF TEMPERATURE.

MANGANIN:
FOR METER AND INSTRUMENT SHUNTS. LOW TEMPERATURE COEFFICIENT. LOW THERMAL EMF AGAINST COPPER.

EVANOHM:
HIGH RESISTANCE AND LOW TEMPERATURE COEFFICIENT REDUCE SIZE AND INCREASE OHMIC STABILITY OF WIRE WOUND RESISTORS.

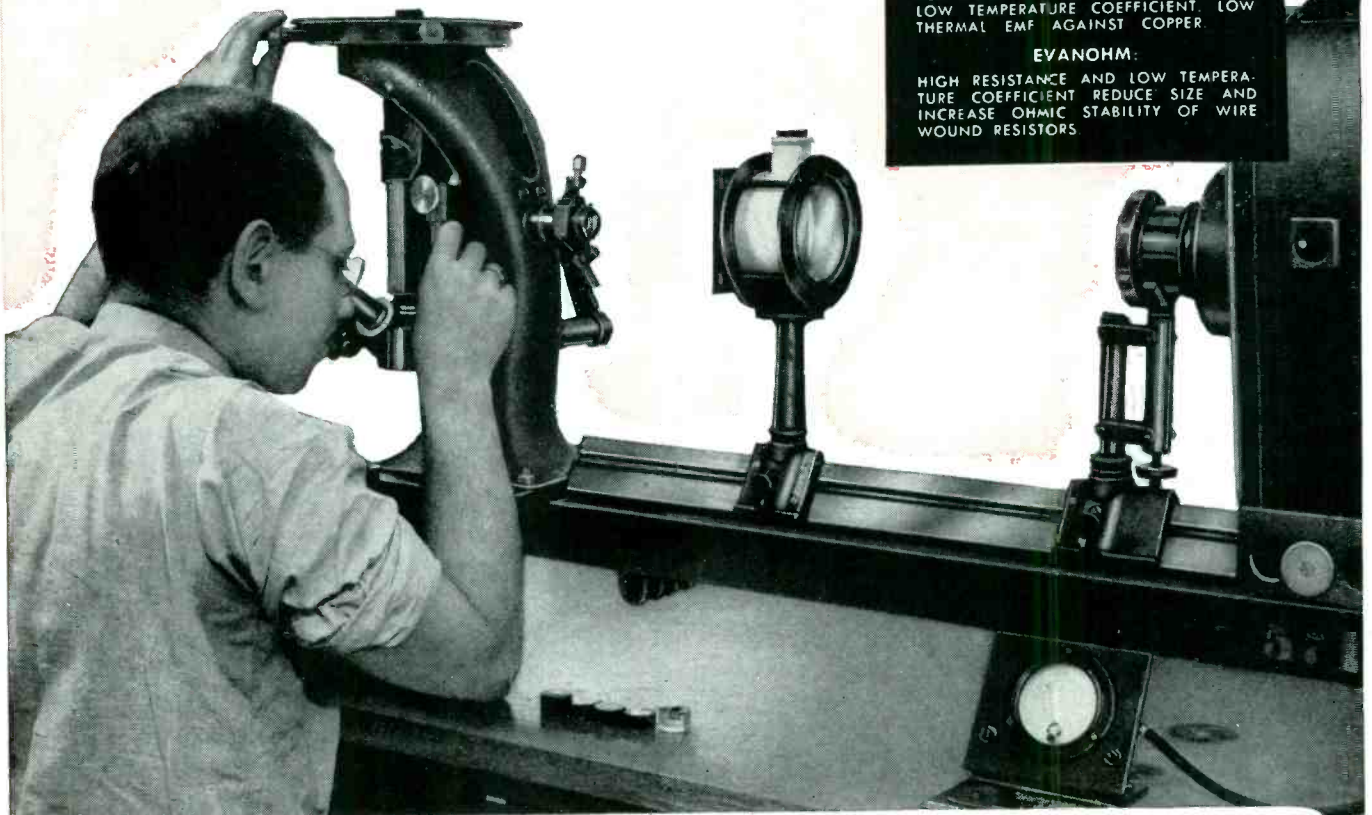

WILBUR B. DRIVER CO.
150 RIVERSIDE AVE., NEWARK 4, NEW JERSEY

LEDEX ROTARY SOLENOID



... solves remote control problems

The many production uses of Ledex Rotary Solenoids vary from actuating bomb releases in military aircraft to controlling hydraulic valves in heavy duty industrial material handling equipment.

Five Ledex Rotary Solenoid models are manufactured. Diameters range from 1 1/8 to 3 3/8 inches. Predetermined rotation up to 95°, either right or left, can be engineered to suit your production requirements. Starting torques for 45° of rotation range from 1/4 to 50 pound-inches.

Precision manufacture to exacting specifications and individual operating tests are your assurance of dependable, long-life service under severe operating conditions.

Magnetic action moves the armature along the solenoid axis. This action is converted into a rotary motion by means of ball bearings on inclined races.

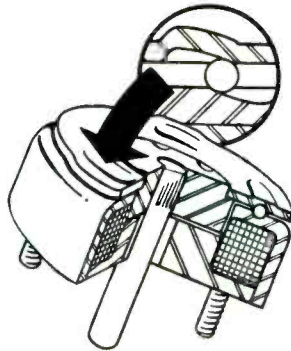

G. H. Leland INC.
DAYTON 2, OHIO

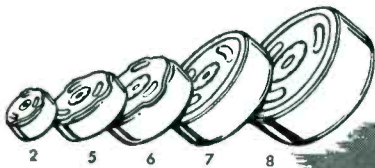

MODEL No.	2	5	6	7	8
Diameter	1 1/8"	1 7/8"	2 1/4"	2 3/4"	3 3/8"
Torque Lb.-Inches	1/4	5	10	25	50
Weight Lbs.	1/8	1/2	1	2 1/4	4 1/4

G. H. LELAND, INC.
118 Webster Street, Dayton 2, Ohio

Send descriptive literature on the Ledex Rotary Solenoid. The Ledex Rotary Solenoid may be applicable to our . . .

Product _____

Name _____
(Please Print)

Company _____

Street Address _____

City _____ State _____

FILL IN
AND MAIL
COUPON FOR
ILLUSTRATED
FOLDER GIVING
COMPLETE
INFORMATION

TUBES AT WORK

(continued)

development, is designed specifically for such use. Two cathode connections are provided so that the series connection can be made in the circuit supply line, and the tube is designed to burn out this connection when the tube is operated directly across a 110-volt source. The cathode connections normally carry about 1.5 ampere.

Improving Performance of Milliwatt Relays

BY GENE HALPERIN
Sands Point, N. Y.

MANY RELAYS of the sensitive polarized type operating on as little as one-half milliwatt have contact characteristics which make operation in aircraft or other mobile applications difficult. The causes for unsatisfactory operation are generally inherent in the physical design or a function of the high sensitivity of the relay.

Several milliwatt relays investigated for use in an airborne temperature control exhibited al-

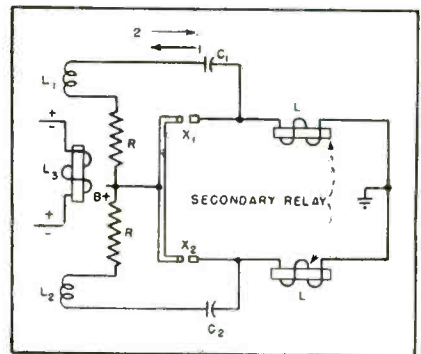

FIG. 1—Operation is improved by addition of coils L_1 and L_2 .

most a linear relationship between input current to the coil and contact-arm motion. Where the input signal is a slowly varying function, such as in a temperature control, this linearity can cause the moving contact to hover a few ten-thousandths of an inch away from the fixed contact.

Under these conditions any small vibration or variation in line voltage can cause a momentary closure of the contacts, but since there is not yet enough input to develop contact pressure, the moving arm when relieved of the disturbing force (vibration or voltage variation)

PLASTIC and METAL

*together, as steady
fast a team as*

DAMON and PYTHIAS

Below . . . A Clarostat
Wire-wound Potentiometer and Rheostat
Product shown thru courtesy of
CLAROSTAT MANUFACTURING CO., INC.

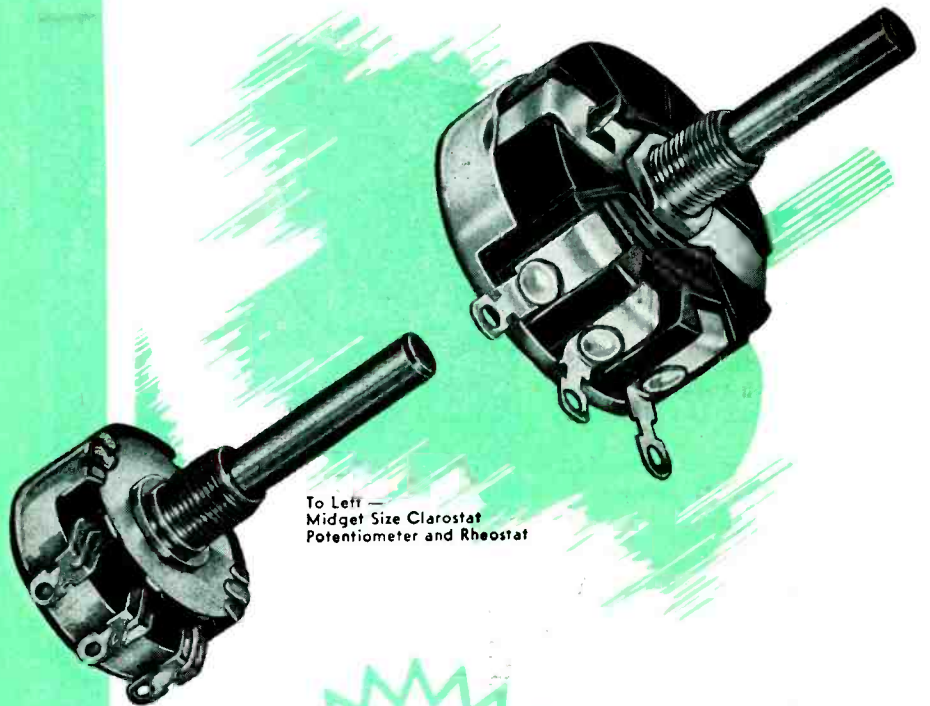

To Left —
Midget Size Clarostat
Potentiometer and Rheostat

CLAROSTAT CONTROLS SOLVE RESISTANCE PROBLEMS

In fact, as Clarostat states it, "Clarostat is interested solely in resistance. This specialization is reflected in the personnel and material engaged in Clarostat production. Every worker, machine, operation represents the end result of over a quarter-century spent in learning how to make quality resistors at mass-production prices."

Consolidated as a plastics production source, holds this company's precision requirements in highest regard . . . for we, too, after many years of service have built our custom-molding reputation upon quality. For your products, too, some plastic may help metal components to behave best — perform best! We'd be glad for the opportunity to discuss the possibilities with you. Inquiries invited!

When Metal Controls are Anchored in Plastic -- They Stay Put!

Plastic maintains a strong — and goodly — influence over Metal . . . especially when designed as base structures for complex circuit assemblies.

Modern mold development encourages product designers to specify in plastic the most involved arrangement of levels, channels, holes, slots and recesses . . . each precision-positioned so that when the metal components are assembled, thereto, they fit like a glove!

NOTE PHOTOS HEREWITH

They indicate what proven molding techniques can accomplish in small space. Both bases shown actual size. Featured reference to letters "A" identify specially recessed channels for permanently positioning and accurately anchoring multiples of metal terminals . . . Final assemblies are pictured at top of page.

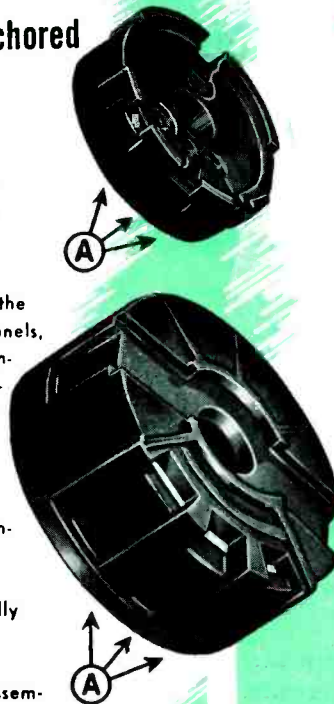

Consolidated

MOLDED PRODUCTS Corporation
309 CHERRY STREET,
SCRANTON 2, PA.

Your Blue Print in Plastic



PRODUCT DEVELOPMENT • MOLD DESIGN • MOLD CONSTRUCTION • PLUNGER MOLDING • TRANSFER MOLDING • INJECTION MOLDING • COMPRESSION MOLDING
Branches: NEW YORK, 1790 Broadway • CHICAGO, 549 W. Randolph St. • DETROIT, 550 Maccabees Bldg. • CLEVELAND, 4614 Prospect Av. • BRIDGEPORT, 211 State Street.

MEASUREMENTS CORPORATION

TELEVISION STANDARD SIGNAL GENERATOR

MODEL 90

SPECIFICATIONS:

● **CARRIER FREQUENCY**

RANGE: Continuously variable from 20 to 250 megacycles, in eight ranges.

ACCURACY: Crystal frequency standard permits setting to .01%. Dial scale may be set to 0.1%.

STABILITY: Warm-up drift less than .05%.

LEAKAGE: Less than 10 microvolts.

● **MODULATION**

Continuously variable from zero to 100%.

ENVELOPE: Sinusoidal, or composite television. Bandwidth to 3 db is 4 Mc. Rise time from 10% to 90% modulation 0.15 microsecond. Overshoot less than 5%. Slope less than 5% on 60 cycle square wave.

INPUT IMPEDANCE: 75 ohms \pm 10% (RMA Standard).

INPUT LEVEL: 1.5 volts peak to peak minimum level for 100% modulation. Black negative polarity.

MODULATION PERCENTAGE: Zero to 110%; plate modulation.

● **OUTPUT**

LEVEL: Continuously variable from 0.3 microvolt to 0.1 volt balanced to ground (measured at 100% modulation level).

IMPEDANCE: (a) 107 ohms line to line (balanced).

(b) 53.5 ohms line to ground (unbalanced).

(c) Suitable pads may be employed to alter these impedances.

● **DIMENSIONS**

OVERALL: Height—58 $\frac{3}{4}$ " ; Width—28 $\frac{1}{4}$ " ; Depth—25 $\frac{1}{2}$ ".

WEIGHT: Model 90—302 pounds.

External Voltage Regulator 92 pounds.

POWER SUPPLY: 117 volts, 60 cycles.

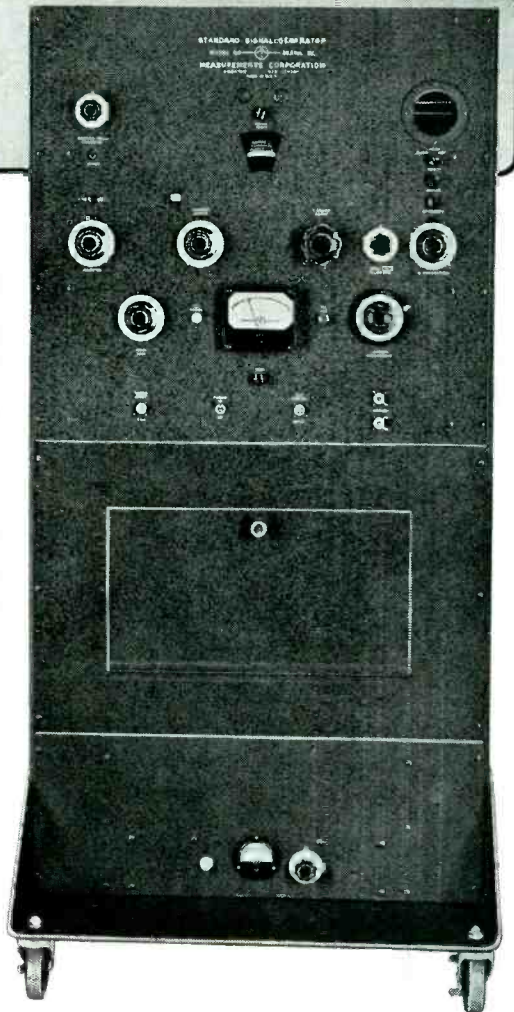

THE FIRST COMMERCIAL WIDE-BAND, WIDE-RANGE SIGNAL GENERATOR EVER TO BE DEVELOPED

The Model 90 employs a master oscillator, buffer amplifier and modulated power amplifier. The push-pull buffer eliminates incidental frequency modulation.

Features: A self-contained crystal calibrator and individually calibrated dial scales permit frequency settings to a high degree of accuracy. A built-in video modulator with manual or automatic dc inserter, designed to operate from a standard RMA composite signal. Continuous monitoring is provided by built-in oscilloscope.

This signal generator meets the most exacting standards required for high definition television use.

ADDITIONAL DATA ON REQUEST

TUBES AT WORK

(continued)

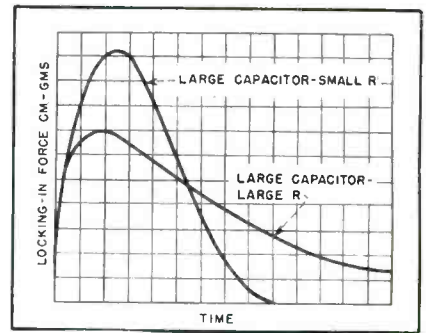

FIG. 2—Locking force as a function of RC

leaves the fixed contact drawing a small arc in the process. This arc maintains itself until the input is sufficiently high to develop contact pressure or until the arc causes welding of the contacts.

These arcs are of small, almost microscopic size and the welds would not be serious in a power relay. However, in sensitive relays, the arc generally passes enough current to cause chattering of the secondary relays with attendant intermittent operation of the control or indicating mechanism. In addition the welds cause shifts of the drop-out point. Some improvement may be effected by R-C suppressors used across the milliwatt relay contacts, but severe vibration will still cause unstable contact operation.

Figure 1 shows modifications made to a milliwatt relay, to make it more satisfactory for applications involving slowly changing quantities and severe vibration. The main winding of the sensitive relay is shown at L_2 connected to any source of d-c of reversible polarity, such as a resistance bridge.

Closing of Contacts

The movable armature carrying the two contacts X_1 and X_2 is connected to a source of voltage which operates the secondary relays when X_1 or X_2 make contact with their respective fixed surfaces. Coils L_1 and L_2 have been added to the relay and are located at the bottom of the coil form, underneath the main winding L_3 . The turns ratio of auxiliary to main winding was chosen as 1 to 10, but can be made greater or less in accordance with the individual requirements of the application.

While contacts X_1 are open, capacitor C_1 is across the d-c line

- MANUFACTURERS OF**
- Standard Signal Generators
 - Pulse Generators
 - FM Signal Generators
 - Square Wave Generators
 - Vacuum Tube Voltmeters
 - UHF Radio Noise & Field Strength Meters
 - Capacity Bridges
 - Megohm Meters
 - Phase Sequence Indicators
 - Television and FM Test Equipment

MEASUREMENTS CORPORATION
 BOONTON NEW JERSEY

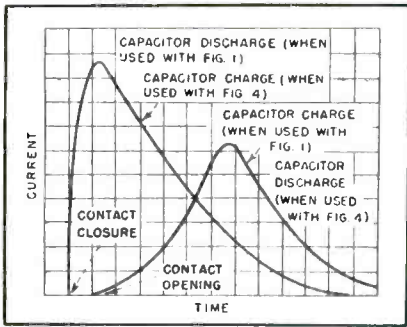

FIG. 3—Difference in charge and discharge action caused by secondary relay

through resistor R , auxiliary winding L_1 and the coil of the secondary relay L . It therefore assumes the potential of the voltage source. The first momentary contact between the surfaces of X_1 (even of a transient nature) allows the capacitor to initiate a discharge through the auxiliary winding L_1 , resistor R and the closed contacts. The discharge has a current flow in the direction of arrow 1 and a magnitude fixed by the capacitance of C_1 , the emf of the voltage source, resistance R and the d-c resistance of the auxiliary winding. If winding L_1 is phased so that current in the direction shown by arrow 1 generates ampere-turns additive to those of the main winding, a transient locking impulse is achieved. The armature is immediately subjected to an additional mechanical force due to the increased ampere-turns and locks in tightly to its fixed contact.

The magnitude of the locking impulse and its duration are determined by the magnetic circuit and the nature of the typical exponential discharge of the R-C combination. By suitable selection of the three variables the transient mechanical force on the armature can be adjusted through a wide range.

Figure 2 shows various methods of operation based on variations of R and C and the resultant variations in transient locking force. It also shows that, for any fixed number of turns in each auxiliary winding, it is possible to get a large locking impulse for a short time or a lesser locking impulse for a long time.

The choice of variable will be dictated by the specific application but the chosen parameters should allow the exponential locking impulse to

The advertisement features a large, detailed illustration of a cylindrical resistor tube with mounting tabs at each end, set against a blue background with white motion lines. In the upper left corner, there is a small black-and-white cartoon illustration of a character with a large head and a small body, holding a parasol and looking down at a coiled wire. Below the resistor tube, the text reads:

MOISTURE costs you money

Ward Leonard Resistors stand up under prolonged exposure to high humidity

Hermetic sealing with crazeless vitreous enamel, made from Ward Leonard's own special VITROHM, enables the Ward Leonard resistor to stay on the job. They are even unaffected by thermal shock.

Ward Leonard resistors are "Result-Engineered". By modifying a basic design, Ward Leonard can give you the results of a special . . . for the cost of a standard.

Write for Resistor Catalog, Ward Leonard Electric Co., 31 South Street, Mount Vernon, N. Y. Offices in principal cities of U. S. and Canada.

WHERE BASIC DESIGNS IN ELECTRIC CONTROLS ARE RESULT-ENGINEEED FOR YOU



WARD LEONARD ELECTRIC COMPANY

RESISTORS • RHEOSTATS • RELAYS • CONTROL DEVICES

The Life of Your Product Hangs by a Thread!

Yes, your product's length of life in consumer service is determined to a large extent by the precision and strength of threads—the threads of screws, bolts, nuts and allied threaded fastenings used in its assembly.

The old adage "a chain is as strong as its weakest link" applies perfectly to the assembly of your product. Obviously, it can be only as strong, precise, efficient and enduring as its fastenings.

HOLTITE Engineered Fastenings are precision-made to resist the loosening effects of vibration. Scientific processing and heat-treating of laboratory-selected materials assure strength far beyond ordinary demands. Under vigilant, skillful supervision these qualities of strength and precision are combined to produce fastenings that effect economies in application and permanence in performance.

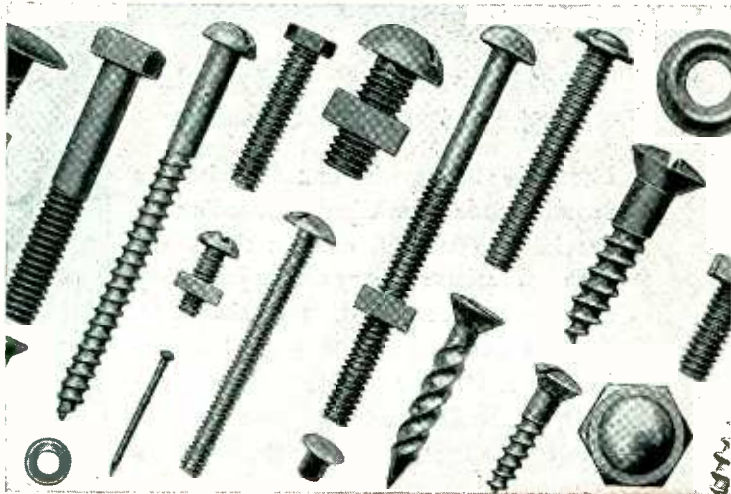

The HOLTITE line comprises a complete range of dependable fastenings in all standard styles, sizes, finishes and heat treatments. Furnished with HOLTITE-Phillips Recessed Heads or slotted heads. SPECIALS made to order exact to your specifications, blue prints or samples.

CONTINENTAL
SCREW CO. New Bedford, Mass., U.S.A.

fall to at least 10 percent of its initial value before it is time for the contacts to open. In other words, the shortest period of contact closure to be expected in any particular application will determine the maximum decay time of the transient impulse. This limitation is obviously necessary in order that the drop-out characteristics of the relay be unaffected by the presence of the additional transient ampere-turns.

Opening of Contacts

If the maximum decay time is made shorter than the smallest period of contact closure, the capacitor will always be in a substantially discharged condition by the time contacts X_1 break the circuit. Capacitor C_1 , resistor R and winding L_1 will again be subjected to the supply voltage and a charging current will flow in the direction of arrow 2. Without mechanical switching, a reversal of current flow has been achieved in auxiliary winding L_1 and a negative or kick-out impulse will be applied to the armature.

The capacitor discharges exponentially on closure of X_1 but does not charge in the same manner because of the presence in the charging circuit of the highly inductive secondary relay coil. This action is illustrated in Fig. 3 where the discharge current rises almost as a step function (limited in rate of rise only by small inductances in the capacitor, wiring and coil L_1) and then falls exponentially to zero, while the charging current rises much more slowly to a maximum and then tapers off to zero.

Time Delay

A by-product of the circuit operation as described above is a finite amount of time delay in the opening of secondary relay L due to the charging current of capacitor C_1 which passes through the secondary relay coil L in the same direction as its normal closing current. This small delay in the opening of the secondary contacts is of considerable advantage in achieving stability in certain applications. Unfortunately, it is not always possible to achieve the desired amount of time delay when parameters are

NEW ELECTROLYTICS
fully dependable
TO 450 VOLTS AT 85°C



ILLUSTRATIONS
 ACTUAL SIZE

for TELEVISION'S exacting applications

Designed for dependable operation up to 450 volts at 85°C. these new Sprague electrolytics are a good match for television's severest capacitor assignments. An extremely high stability characteristic is assured, even after extended shelf life, thanks to a special Sprague processing technique. Greatly increased manufacturing facilities are now available.

Your inquiries concerning these new units are invited.

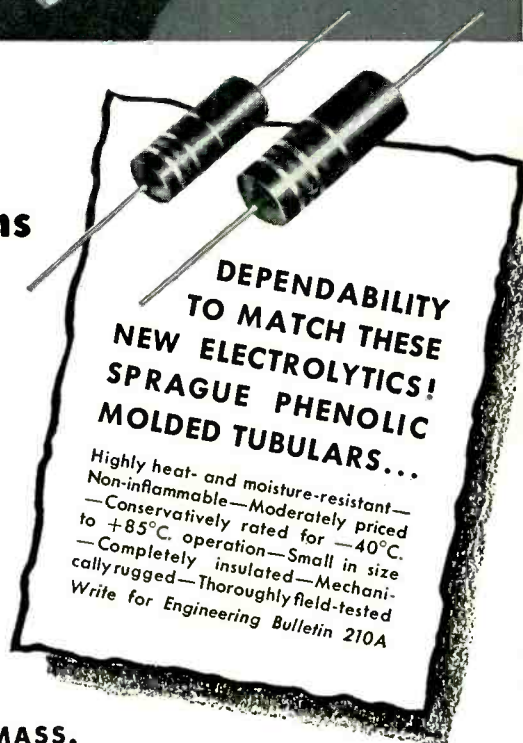

**DEPENDABILITY
 TO MATCH THESE
 NEW ELECTROLYTICS!
 SPRAGUE PHENOLIC
 MOLDED TUBULARS...**

Highly heat- and moisture-resistant—
 Non-inflammable—Moderately priced—
 —Conservatively rated for —40°C.
 to +85°C. operation—Small in size
 —Completely insulated—Mechani-
 cally rugged—Thoroughly field-tested
 Write for Engineering Bulletin 210A

SPRAGUE ELECTRIC COMPANY · NORTH ADAMS, MASS.

SPRAGUE

Capacitors

* Koolohm Resistors

PIONEERS OF

ELECTRIC AND ELECTRONIC PROGRESS

*T. M. Reg. U. S. Pat. Off.

NEW!
 Remarkable
 HEAT RESISTANT
 MATERIAL

GRADE G-7-830

SILICONE FIBERGLAS
 LAMINATE

PHENOLITE
 Laminated PLASTIC

Possesses these Exceptional Properties

Tensile Strength	19,000 lbs./sq.in.
Flexural Strength	44,000 lbs./sq.in.
Compressive Strength	46,000 lbs./sq.in.
Water Absorption (1/16" thk.-24 hrs.)	0.15%
Power Factor, 10 ⁶ cycles—Dry	0.0012
Power Factor, 10 ⁶ cycles—(after 24 hrs. water immersion)	0.0086
Dielectric Constant, 10 ⁶ cycles	3.90
Dielectric Loss Factor, 10 ⁶ cycles0048
Insulation Resistance	71,600 megohms
Dielectric Strength	485 volts/mil
Arc Resistance (ASTM method)	228 seconds



GRADE G-7-830 Phenolite combines high heat, flame and arc resistance. It is recommended for exacting low loss electrical applications and for insulation in transformers, motors, electric toasters and other applications subjected to elevated temperatures.

For full details call or write

NATIONAL VULCANIZED FIBRE CO.

WILMINGTON 99, DELAWARE
 Offices in the Principal Cities

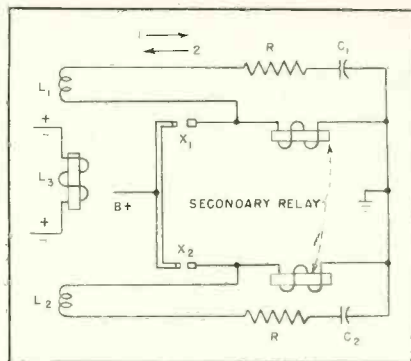

FIG. 4—Alternate circuit in which the charge and discharge actions are reversed from that of Fig. 1

chosen on the basis of locking and kick-out forces, but where such delay is beneficial and necessary, a compromise between locking force, duration and secondary time delay can usually be achieved.

The combination of R and C_1 constitutes a spark suppressor to reduce the arc across the contacts X_1 and X_2 , in addition to its other functions.

Alternative Circuit

Figure 4 illustrates an arrangement which can be used in extreme cases of inadequate relay operation. It enables auxiliary winding L_1 to utilize to full advantage the discharge of C_1 without any attenuating effects from the opposite side of the circuit. The auxiliary winding circuits are connected across the secondary relay coils. The action of the transient network is now reversed from that shown in Fig. 1, since C_1 is discharged during the time that contacts X_1 are open and charges when they are closed, due to the line voltage which appears across the secondary relay coil.

The system operates as follows: When contacts X_1 close, the line voltage appears across the secondary relay coil. The rise of relay current lags due to inductance in the coil, but the voltage appears as a step-function. This causes a charging current to flow through winding L_1 , capacitor C_1 and resistor R in the direction shown by arrow 1. The fact that the rise of current lags in the relay coil does not delay the charging of C_1 since the capacitor draws its charging power from the line. As the capacitor reaches line voltage, current 1 is reduced to zero and remains



Columbus equipment reaches fires faster sped by 2-way *Motorola* Radio and Sylvania Lock-In Tubes

Those first few minutes are *vital* in fighting a fire!

That's why the Columbus (Ohio) Fire Department counts on Motorola 2-way FM to maintain constant touch between the dispatcher's office and 24 radio-equipped vehicles. Equipment returning to the firehouse can be instantly diverted en route—dispatched to the scene of a new alarm.

And where fires are potentially big enough to call for *additional* equipment to bring them under control, a radio message from the scene to the dispatcher's office has the extra vehicles under way within seconds!

For requirements like this, Motorola counts on Sylvania Lock-In Tubes to help maintain uninterrupted, efficient performance of its mobile units. These tubes stay firmly in place through jolting and jarring. They have few welded joints, no soldered ones. No warping or weaving of elements. Low loss, low leakage. See Sylvania Distributors, or write Radio Tube Division, Emporium, Pa.



Dispatcher's office is in constant communication with vehicles at all times, directing them to the scene, checking on progress in bringing fire under control.

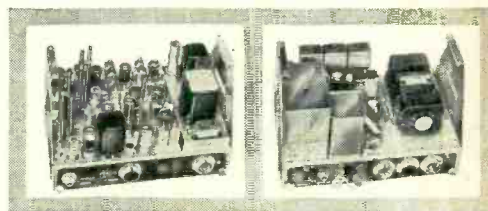

Mobile FM transmitting and receiving units built by Motorola, Inc., Chicago, and used in 24 vehicles of the Columbus Fire Department.

Superior mechanical and electrical features of Sylvania Electric's famous Lock-In Tube make it ideal for equipment on the road, in the air, on the rails—for marine radar, FM and television.



SYLVANIA ELECTRIC

RADIO TUBES; CATHODE RAY TUBES; ELECTRONIC DEVICES; FLUORESCENT LAMPS, FIXTURES, WIRING DEVICES; LIGHT BULBS; PHOTOLAMPS

ELECTRONICS — November, 1948

147

Whether MICROPHONE or SPECIAL AMPLIFIER

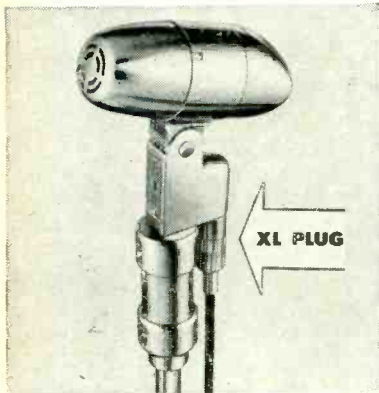

Photo Courtesy Electro-Voice, Inc.

Model No. 645 Broadcast Microphone made by Electro-Voice, Inc., Buchanan, Mich. used an XL Plug as standard disconnect equipment. This is only one of the several Electro-Voice microphones "XL"-equipped.



Photo Courtesy Brown Geophysical

Special amplifier used in oilfield geophysical exploration and survey by Brown Geophysical Co. of Houston, Texas uses K connectors for the circuits on this Amplifier equipment.

Plug-in with CANNON PLUGS

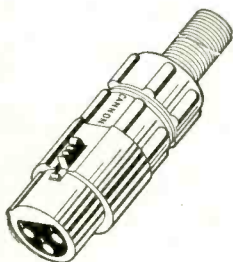

TYPE "XL" Series is two plugs and several receptacle types, with two insert variations of 3 and 4 contacts, 10 and 15-amp. Latchlock type connection.



TYPE "K" Series is made in several shell types, including the "RK", and approximately 190 insert arrangements among the 8 shell sizes for a wide variety of wire sizes, including coaxials.



For a survey of Cannon Plugs, write for the C-47 Condensed General Catalog, covering the 13 major type series and electrical specialties. . . Details on Type "K" are found in the K-945 Bulletin. Address Department K-120.

CANNON ELECTRIC



SINCE 1915

Development Company

3209 HUMBOLDT ST., LOS ANGELES 31, CALIF.

IN CANADA & BRITISH EMPIRE:
CANNON ELECTRIC COMPANY, LTD.
TORONTO 13, ONTARIO

● WORLD EXPORT (excepting British Empire):
FRAZAR & HANSEN, 301 CLAY STREET
SAN FRANCISCO 11, CALIFORNIA

TUBES AT WORK

(continued)

zero until contacts X_1 open. The voltage across the relay coil decreases as its field collapses and the capacitor discharges with current flow 2.

The discharge current is in the same direction as the normal flow of relay current and can be made large enough to provide some delay in the drop-out time of the secondary relay where this is desirable. This arrangement is particularly advantageous in keeping the two halves of the circuit electrically isolated from each other. The charge and discharge of C_1 on contact closure and on contact opening is shown in Fig. 3.

Camera Shutter Timer

BY HUBERT SEAR

Mount Airy Road
Croton-on-Hudson, N. Y.

MOST of the existing camera shutter timing devices make use of the moving-film or the ballistic galvanometer principle. In the development of the instrument described here, however, these ideas were avoided because of their relative expense, the time element with the former, and the difficulty in construction of the latter.

This instrument requires no critical set-up procedure. A light is placed behind the camera lens and the length of the flash transmitted when the shutter is snapped is measured. A photo-cell transforms this flash into an electric impulse which develops a voltage across the resistor R_1 as shown in the accompanying circuit diagram. This voltage is high enough to fire the neon bulb, which acts as a switch to the circuit R_2, R_3 , developing a voltage across R_3 . One half of the 6SN7 is thus biased to a predetermined value making it conduct a constant known current.

When the light on the photocell is extinguished by the closing of the camera shutter, the firing voltage for the neon bulb is removed and it goes out. This interrupts the current in the bias resistor R_1 , and the triode section is returned to a non-conducting condition. This arrangement eliminates the necessity of a light source of regulated intensity.

Once the neon light switch is

NEW



CAPACITANCE BRIDGE



with a range of TEN BILLION to ONE

Higher Accuracy • Greater Sensitivity • More Operating Conveniences

For Measuring Electrolytic Condensers • Testing Dissipation Factor of Transformer Bushings and Insulators • Measuring Dissipation Factor and Dielectric Constant of Solid and Liquid Dielectric Materials • General Electrical Machinery Insulation Testing • Product Control and Uniformity Production Checks on Materials Sensitive to Variable Electrical Properties

This new Type 1611-A Capacitance Test Bridge has many circuit and operating conveniences which make it highly adaptable to all sorts of capacitance and dissipation-factor measurements. Its enormous range of 1 micromicrofarad to 11,000 microfarads is achieved with the unusually good accuracy of $\pm(1\% + 1 \text{ micromicrofarad})$ over the whole range. For dissipation factor measurements the range is 0 to 60% at 60 cycles, with an accuracy of $\pm(2\%$ of dial reading + 0.05% dissipation factor).

The bridge detector is composed of a single stage amplifier and an electron-ray visual null indicator. The detector

is designed to be very sensitive when the bridge is at or near balance, but relatively insensitive when off balance.

A new zero-compensating circuit has been developed to provide marked improvement over previous bridges of this general type when making measurements below 1000 micromicrofarads.

For measurements on electrolytic condensers, a polarizing voltage, up to 500 volts, may be applied, from a grounded power supply if desired. Terminal capacitances of the power supply do not affect the accuracy of the bridge.

The bridge and its accuracy are unaffected by temperature and humidity variations over normal room conditions (65 deg. F. and 0 to 90% RH).

The ac-voltage applied to the capacitance under test varies from approximately 125 volts at 100 micromicrofarads to less than 3 volts at 10,000 microfarads.

This bridge combines all of the principal operating features of our popular Type 740-B and Type 740-BG bridges but improves the performance of each in most of their important characteristics.

TYPE 1611-A Capacitance Test Bridge... \$375.00
WRITE FOR COMPLETE INFORMATION

GENERAL RADIO COMPANY

90 West St., New York 6

920 S. Michigan Ave., Chicago 5

950 N. Highland Ave., Los Angeles 38

**Cambridge 39,
Massachusetts**

Out in Front!

KESTER "RESIN-FIVE" CORE SOLDER

containing a **NEW FLUX**
that is more active, stable and
efficient than any rosin flux—yet
NON-CORROSIVE • NON-CONDUCTIVE

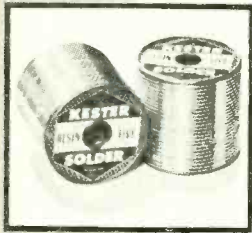

ACTIVITY "Resin-Five" will solder zinc, brass, nickel silver, nickel-plate, copper and ferrous alloys.

STABILITY Under the most extreme soldering temperatures the Flux still does the soldering job.

MOBILITY The unusual activity and stability of "Resin-Five" give it complete mobility.



KESTER "RESIN-FIVE"

The most important development in Cored Solder within the last ten years. "Resin-Five" has virtually no odor even at extreme temperatures. Available in 5 core sizes; varying percentages of flux content. Diameters ranging from .010" to .250". All practical alloys.

A COMPLETE TECHNICAL SERVICE

Any soldering problems? Consult our Technical Department. No obligation to you.

**KESTER
SOLDER COMPANY**

**KESTER
SOLDER**

4204 Wrightwood Ave., Chicago 39, Ill.

Factories Also At

Newark, New Jersey • Bramford, Canada

TUBES AT WORK

(continued)

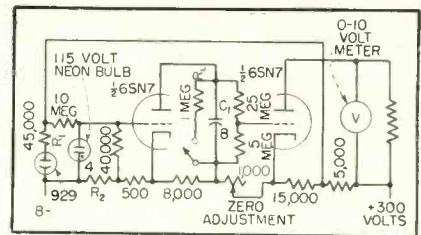

Schematic diagram for electronic shutter timer. The 0-10 voltmeter shows shutter time directly in seconds

closed, a constant bias is applied to the triode regardless of the size of the photocell current. Therefore the magnitude of the plate current is constant for as long as it is permitted to flow by the light flash. The voltage drop across the plate resistor charges capacitor C_1 . This charging proceeds slowly because of the long time constant of this R-C circuit. In usual operation the capacitor is never completely charged. When the plate current is extinguished, the capacitor slowly discharges through the plate resistor causing a voltage to appear across it, proportional to the charge. Since the charge depends on the duration of the charging pulse, the voltage across the capacitor is proportional to the duration of that pulse, or the duration of shutter opening. This discharge voltage is taken from part of the plate resistor and applied to the grid of the second half of the 6SN7 used as a d-c amplifier. A voltmeter in this plate circuit indicates shutter speed directly in seconds.

The grid voltage for this last stage is not taken across the whole plate resistor since such a high resistance in the grid circuit would cause appreciable drifting due to the grid current. If adjusted correctly with the values shown, sufficient voltage may be obtained across part of this resistor without appreciable grid current effect. Grid current in the first stage prevents the use of this R-C circuit in its grid. Three selenium rectifiers are used in a voltage tripler circuit to furnish the high voltage (about 300 volts) which is necessary for proper biasing of the d-c amplifier. An ordinary gooseneck desk lamp has been used satisfactorily with the unit described.

Because of tube variables and other changes common with d-c

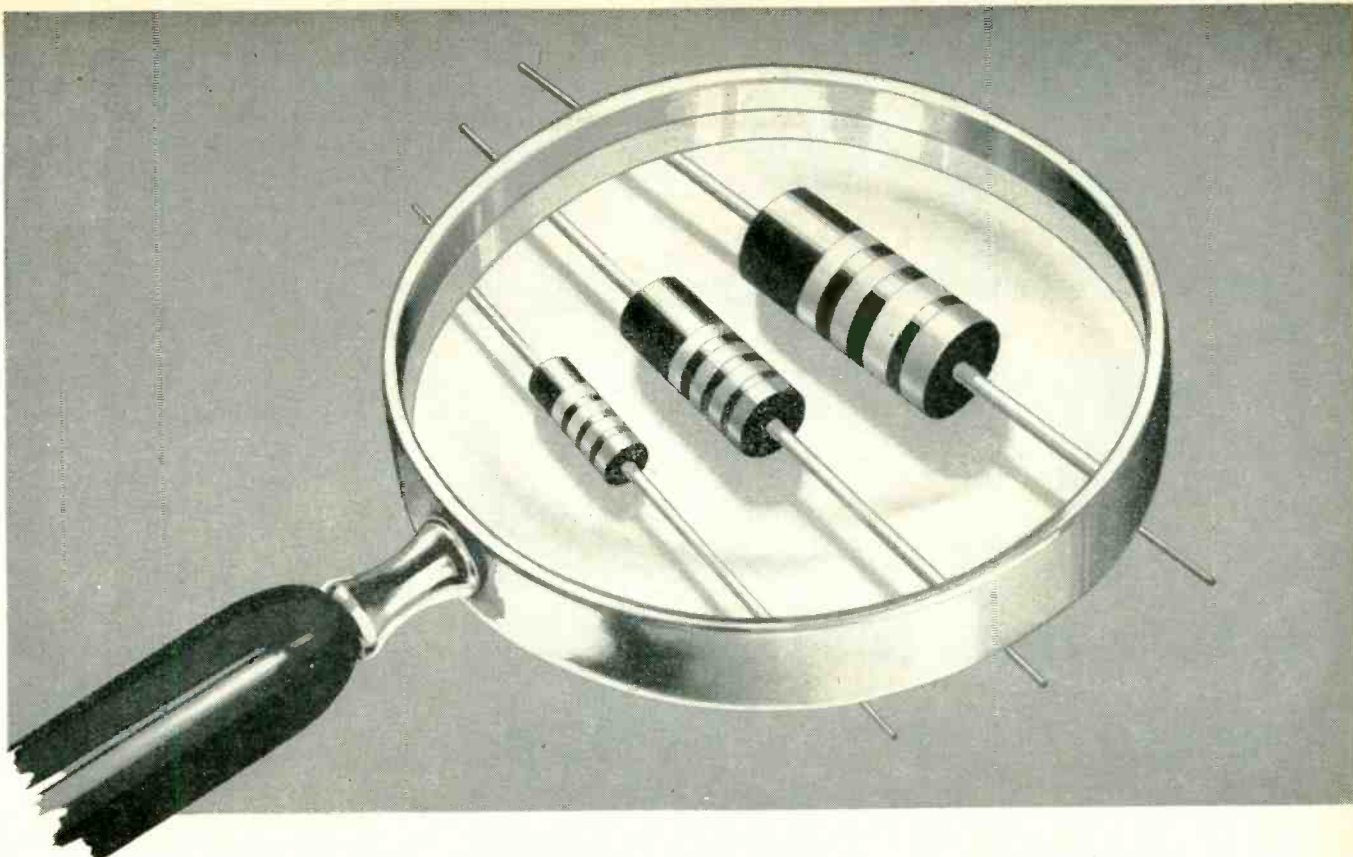

BRADLEYUNITS

½ WATT • 1 WATT • 2 WATT
Small in Size • Big in Wattage

Bradleyunits are so small for their ratings that we can't picture their exceptional capacity . . . without magnifying them. So here they are . . . available in all standard R.M.A. values, as follows:

- ½-watt rating—10.0 ohms to 22 megohms
- 1-watt rating— 2.7 ohms to 22 megohms
- 2-watt rating—10.0 ohms to 22 megohms

Bradleyunits will operate at full rating for 1000 hours at 70°C ambient temperature with a resistance change of less than 5%. They require no wax impregnation to pass salt-water immersion tests and have high mechanical strength and permanent characteristics. Let us send you a complete Allen-Bradley resistor chart.

Allen-Bradley Co., 110 W. Greenfield Ave., Milwaukee 4, Wis.

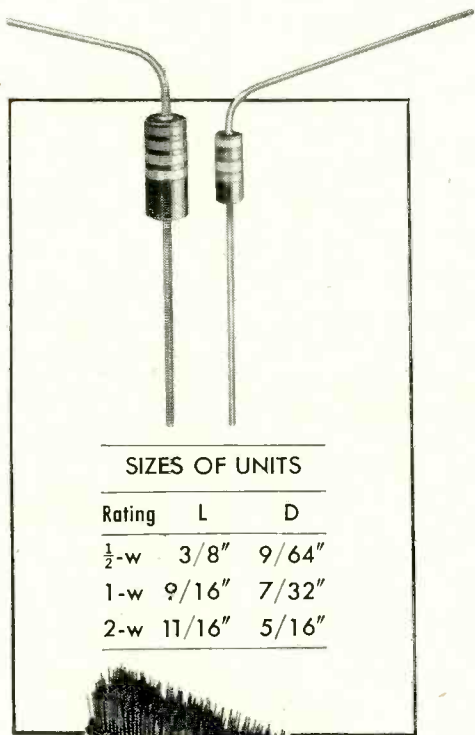

SIZES OF UNITS

Rating	L	D
½-w	3/8"	9/64"
1-w	9/16"	7/32"
2-w	11/16"	5/16"

Packed in convenient
honeycomb cartons
for quicker assembly.

ALLEN-BRADLEY
FIXED & ADJUSTABLE RADIO RESISTORS

Sold exclusively to manufacturers

QUALITY

of radio and electronic equipment

amplifiers, the zero point must be reset about once a day. A low resistance R_L is also included to be switched in parallel with the high resistance of the R-C circuit so that the meter needle may be returned to zero more quickly than the natural discharge would allow. A type 929 photocell is used in preference to the higher output gas types because the speed of response is better.

Although the accuracy of the device is good enough for shop work, the difficulties inherent in d-c devices using vacuum tubes make it inadvisable for more exacting applications. Furthermore, due to the dependance on an R-C combination, the range is limited. Shorter time constants would cause the meter to move too fast to be read. The combination shown may be used from about 1/10 to 1/350 second.

A more versatile device now under consideration has an extended range and is an a-c instrument and therefore not subject to the inaccuracy of a d-c amplifier and hence is more suitable for the laboratory. It is, however, less suitable for a repair shop because it is also more expensive. An r-f oscillator suitably isolated and crystal stabilized, feeds its output to a scaling circuit through a gating tube. The impulses are gated by the photocell voltage. The number of impulses passed is a function of the time the light is passing the opened shutter. They are counted and scaled down by the scaler and may be indicated in any suitable manner. The range of speeds measurable is limited on one hand by the frequency of the oscillator, and on the other by the capacity of the scaler. Both may be extended almost indefinitely with circuits now available.

Telecontrolled Clocks

CLOCKS connected directly to the 60-cycle line are self-regulated electronically without special clock wiring in a development by International Business Machines Corporation. Each clock is checked individually and automatically once an hour for uniformity with the system time. Should any of the clocks be out of step, owing to a current interruption, they will be corrected

**for POWER, SIGNAL and
CONTROL CIRCUITS
in AIRCRAFT and
ELECTRONIC EQUIPMENT**

AMPHENOL "A N" CONNECTORS

Ruggedness for AIRCRAFT SECURITY . . .

Stronger shells, stronger insulation, lowest resistance contacts with wiring solder pockets aligned for quick, convenient connections. Built to quality standards beyond the already rigid specifications for AN Connectors. Amphenol pioneered in the engineering of this rugged and efficient line of connectors for use in military aircraft. To be sure of top performance, specify Amphenol AN Connectors and Fittings.

Write for the new AN Catalog A-1. It's abundant with the latest connector information and contains timesaving listings and indexes for the engineer and buyer. Mail your request on company letterhead to Department 13-B.



AMERICAN PHENOLIC CORPORATION
1830 SOUTH 54TH AVENUE, CHICAGO 50, ILLINOIS
COAXIAL CABLES AND CONNECTORS • INDUSTRIAL CONNECTORS, FITTINGS AND
CONDUIT • ANTENNAS • RADIO COMPONENTS • PLASTIC FOR ELECTRONICS



ENGINEERING GIVES YOU

-better readability-

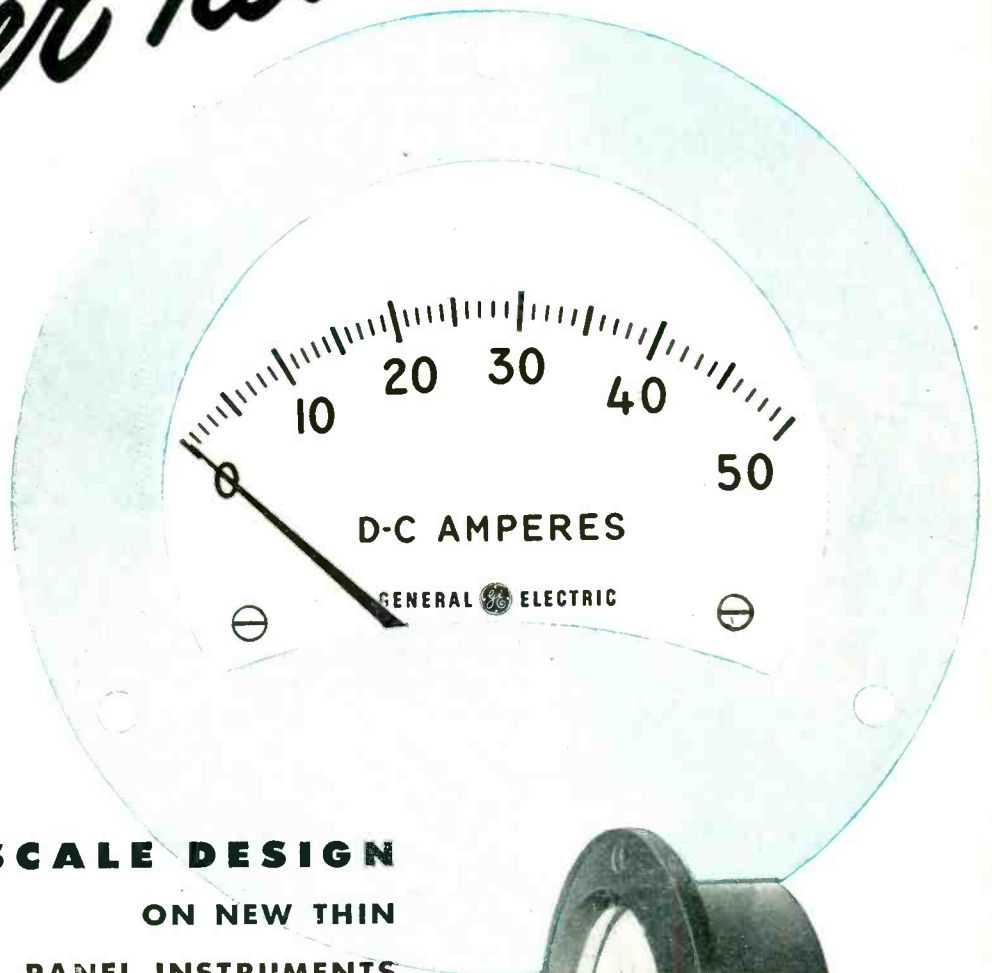

**IMPROVED SCALE DESIGN
ON NEW THIN
PANEL INSTRUMENTS**

The new General Electric thin panel instruments have been designed especially for easy reading. Arc lines have been eliminated to make scale divisions stand out by themselves. New lance-type pointer gives precise indications. Restyled figures are bigger, and shaped for maximum legibility. A mask covers distracting mechanism at base of pointer. And, notice the scale as a whole. All extraneous printing has been removed. You can be sure of quicker, more accurate readings with these new Type DO-71 instruments, as proved by tests before large audiences.

Greater sturdiness, more reliable operation, and longer life are assured by the internal-pivot construction, temperature compensation, and other features described more fully in Bulletin GEA-5102. Write for your copy today. Apparatus Department, General Electric Company, Schenectady 5, N. Y.

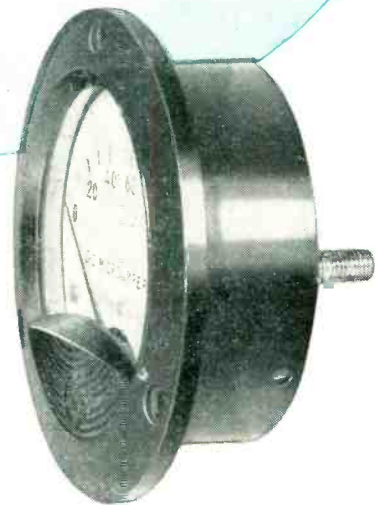

Also available as a-c ammeter, a-c wattmeter, d-c voltmeter, d-c ammeter, temperature indicator, power-factor meter, synchroscope, and frequency meter.

GENERAL  ELECTRIC

602-126

*Write type BH6
into your design
specifications!*



**BLILEY TYPE BH6
APPROVED FOR
PRODUCTION**

**TECHNIQUALITY
CRYSTALS**

Engineered to the "MUST" requirements of current military and commercial communications

When you write Bliley Type BH6 into your specifications you meet all requirements, military or commercial . . . and you have simplified your design considerations by the elimination of unnecessary multiplier stages. Type BH6 is available up to 100 MC. Write us for oscillator circuit recommendations based on your particular requirements.

**Bliley
CRYSTALS**

BLILEY ELECTRIC COMPANY
UNION STATION BLDG., ERIE, PA.

TUBES AT WORK

(continued)

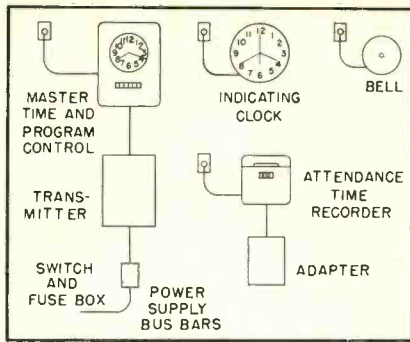

Electronic system for synchronizing clocks, signal units, time stamps and recorders

once an hour up to 59 minutes slow and 55 seconds fast.

The new system would be a convenience to industrial concerns, schools, and hospitals.

In the new system, a master time control is installed and operated from the same alternating current to which the indicating clocks are connected. This control is the director of the entire system and keeps all units in agreement with it. Every hour electronic tube action in a transmitter at the control sends a supervisory impulse out over the power lines. A simple electronic receiver in each indicating clock accepts the impulse. If the clock is slower or faster than the master time control, it corrects itself once each hour automatically. If the clock is in agreement to the second to the master control, it continues to function as an independent clock. Thus, without special wiring, all clocks in a building show the same time.

This IBM system also permits automatic signaling, sounding of bells, horns, buzzers, gongs, or chimes, through the program unit of the master control, without special signal wiring. These signals are also fed to the line to actuate the electronic receivers when an impulse is released to them. Three different schedules of signals may be sounded without special wiring. Self-regulating minute impulse units, attendance time recorders, job cost recorders and time stamps, are operated by the system through use of an adapter. This adapter is connected to the line to receive the hourly corrective impulse sent out by the transmitter. After verifying its own agreement with the time of the master time control, the

It's
GOOD BUSINESS TO SAY:
*"Ship
Railway Express!"*



RAILWAY EXPRESS offers you a complete transportation package. Around its nation-wide facilities is built a convenient, economical shipping service including door-to-door pick-up and delivery in all principal cities and towns at no extra cost. It is designed to meet every one of your business or personal shipping requirements.

Your shipments are carried swiftly over America's railroads and scheduled airlines—providing an all-inclusive service for a single charge. Consistent improvement in equipment and methods is your assurance of a continued, dependable, coordinated shipping service to you, your community and the nation.



THE NATION'S *Complete* SHIPPING SERVICE



NATION-WIDE RAIL-AIR SERVICE

HOW Resistance-Voltage Characteristics are altered by Resistor Design

Here are negative resistance-voltage curves plotted for two GLOBAR type BNR RESISTORS. Both resistors are voltage sensitive. However, the two curves coincide at one point only, namely, 30 volts. But, of more importance, observe how the difference in resistor design drastically alters its characteristics. Note the effect a change in the shape of the resistor has on the slope of its resistance-voltage curve. Fundamentally, this change in characteristics is accomplished by altering the specific resistance of the resistor.

Graphically presented here, this variance in characteristics—caused by resistor design points up an important factor in specifying and ordering GLOBAR resistors to meet exact needs of specific applications. It is a good reason why GLOBAR resistors are not carried in stock, but are quickly made to your requirements.

To save time and trouble in producing for you voltage sensitive resistors that

will do the job for which they are intended, we ask only that you furnish a few simple facts. Briefly tabulated, this necessary information is:

- 1 Type of apparatus in which the resistors are to be used.
- 2 Method of mounting and space limitations.
- 3 Normal operating voltage and peak voltage if available.
- 4 Resistance and inductance of the circuit if available.

- 5 Ohmic resistance of the resistor and allowable plus and minus tolerance.
- 6 Maximum voltage applied continuously or intermittently.
- 7 Duration of load and elapse of time between its application.

For your engineering tests, we can furnish samples in a hurry. For any information that may be helpful in working out your resistor problems, write Dept. V-108, The Carborundum Company, GLOBAR Division, Niagara Falls, N. Y.

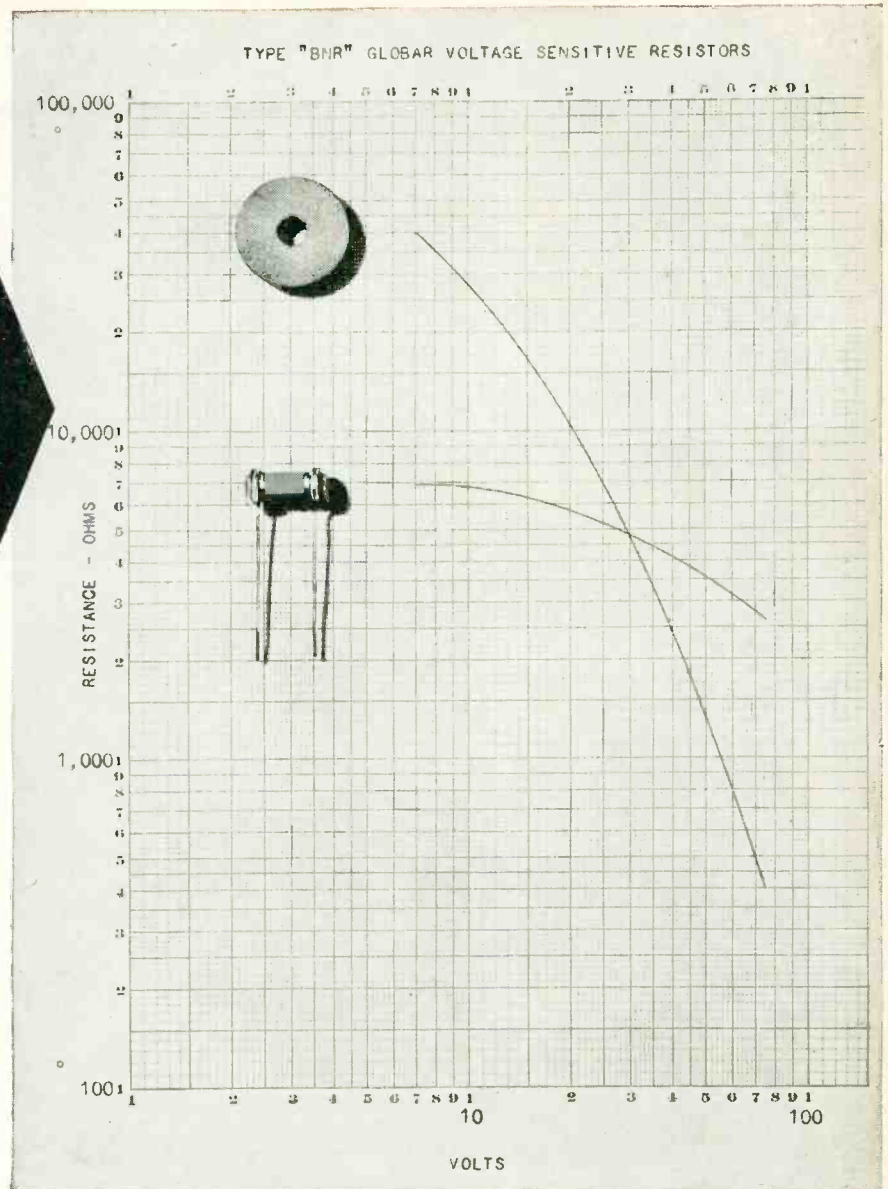

GLOBAR Ceramic Resistors

BY CARBORUNDUM

TRADE MARK

"Carborundum" and "Globar" are registered trademarks which indicate manufacture by The Carborundum Company

1 BILLION to ONE!

SPECIFICATIONS

BALLANTINE MODEL 300 ELECTRONIC VOLTMETER

RANGE: .001 to 100 Volts, r.m.s. (.00001 to 10,000 Volts, with accessories)

ACCURACY: $\pm 2\%$ at any point on the scale.

FREQUENCY: 10 cycles to 150,000 cycles.

STABILITY: Permanent calibration—unaffected by variation in line voltage, tubes, etc.

METER: Logarithmic Voltage scale and uniform decibel scale.

AC OPERATION: Will operate on 105-125 Volts, 50-60 cycles. (Battery operated models also available)



MODEL 300 ELECTRONIC VOLTMETER

since 1935
the only VOLTMETER
featuring a simplified
LOGARITHMIC SCALE

The Model 300 Voltmeter is a valuable tool for measurements in communication and "weak current" engineering. Its unusual sensitivity, accuracy and stability make it ideal for work in the audio, carrier, and super-sonic ranges. Logarithmic meter indication assures uniform accuracy of reading over the whole scale while permitting range switching in decade steps. There is but one scale to read for all ranges. Output jack and output control are provided so that the voltmeter can be used as a high-gain stable amplifier.

Accessories include Model 220 Decade Amplifier, which supplies standardized gains of 10x and 100x, and the Model 402 Multipliers which supply additional ranges of 1,000 and 10,000 Volts.

Descriptive Bulletin No. 12 Available



MODEL 220 DECADE AMPLIFIER



MODEL 402 MULTIPLIER

BALLANTINE LABORATORIES, INC.
BOONTON, NEW JERSEY, U. S. A.

TUBES AT WORK

(continued)

adapter then proceeds to verify the agreement of the minute impulse units with itself and to correct any variations from accurate time which might have occurred in them during the preceding hour.

Sound Flashlight for the Blind

BY VICTOR TWERSKY

*Technical Adviser, Guidance Device Project
Biology Department
City College of New York
New York*

VARIOUS obstacle-detecting devices to aid the blind in foot travel are being studied by research laboratories. A group of students from the City College of New York have developed a relatively simple "sound flashlight" which has proved successful in aiding sightless persons to detect and avoid objects in walking which might otherwise be discovered by collision.

Similar in size and shape to a large flashlight, the unit is carried by the blind person with a scanning motion. Sound waves projected from the unit in a narrow beam are reflected by solid objects, and the reflected sound warns the user of the object's presence.

The heart of the unit is a single-tube oscillator powered by hearing-aid batteries. The circuit is shown in the accompanying schematic diagram. A headphone unit was chosen for the transducer, and its inductance in conjunction with the 0.002- μ f capacitor form a resonant circuit for the desired frequency range between 8 kc and 15 kc.

The choice of this range of frequencies was guided by the consideration of reflection and interference from ambient noises which might be encountered out of doors. It was found advisable to make the frequency adjustable to allow

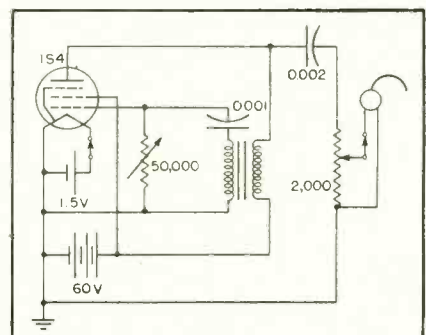

Complete circuit of the obstacle-detecting oscillator

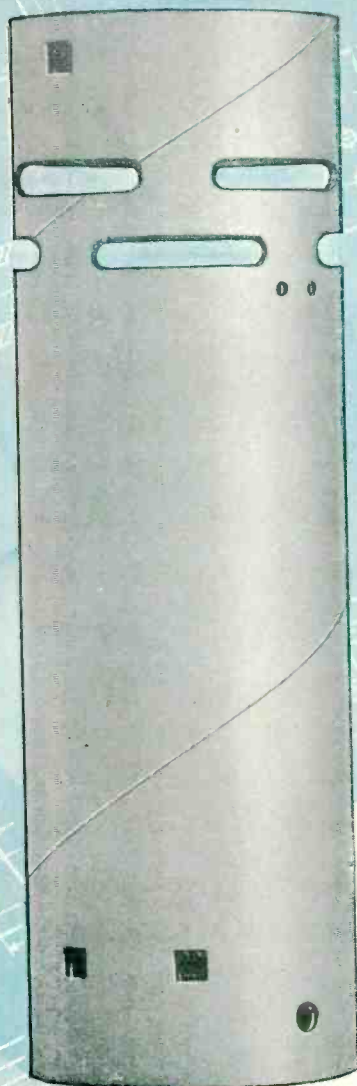

...punching dies available
in endless *Variety* for
COSMALITE*
COIL FORMS

Manufacturers of radio and television receivers
KNOW the outstanding advantages of COSMA-
LITE in both performance and price.

There is a further saving in time and costs through
the use of our extensive number of dies available
to purchasers of Cosmalite Coil Forms.

* Trade Mark Registered

Tell us your needs. Quite prob-
ably we can be of value to
you in your planning and
production. Your inquiry will
receive personal and experi-
enced attention.

The **CLEVELAND CONTAINER Co.**

6201 BARBERTON AVE. CLEVELAND 2, OHIO

- All-Fibre Cans • Combination Metal and Paper Cans
- Spirally Wound Tubes and Cores for all Purposes
- Plastic and Combination Paper and Plastic Items

PRODUCTION PLANTS also at Plymouth, Wisc., Ogdensburg, N.Y., Chicago, Ill., Detroit, Mich., Jamesburg, N.J.
PLASTICS DIVISION at Plymouth, Wisc. • ABRASIVE DIVISION at Cleveland, Ohio
SALES OFFICES: Room 5632, Grand Central Term. Bldg., New York 17, N.Y., also 647 Main St., Hartford, Conn.
CANADIAN PLANT: The Cleveland Container Canada, Ltd., Prescott, Ontario



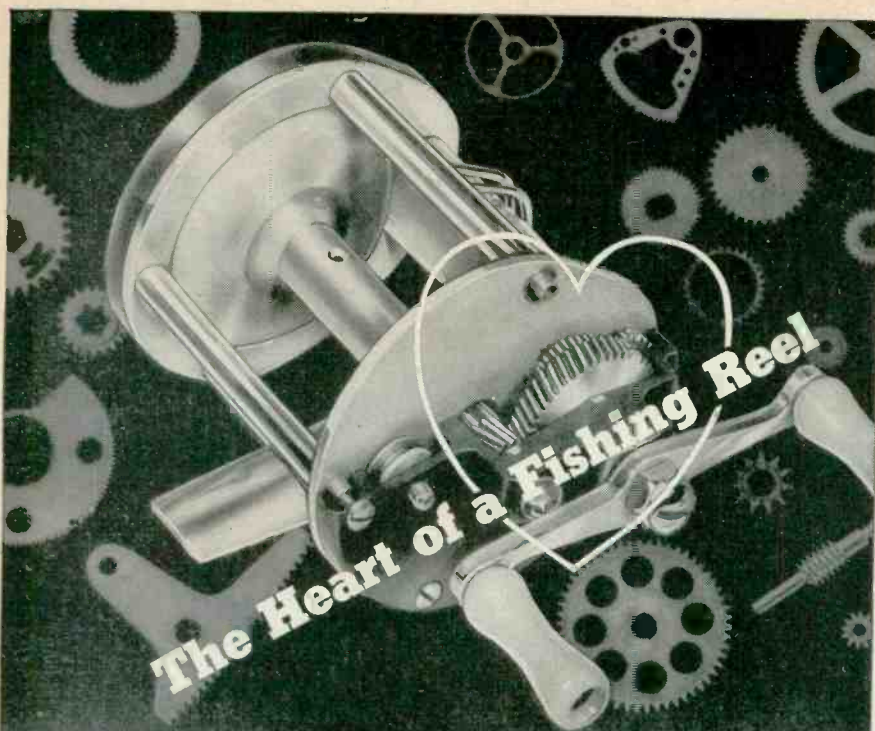

Fishing reel gears must operate smoothly at a speed of 3000 revolutions per minute or more, when a cast is executed. These gears must also withstand the strain of hauling in a fighting fish of unpredictable size and strength, thus rendering a dual purpose: speed and velvety smoothness in one direction—strength and durability in the other.

Instruments and machines have individual gear problems. For over a quarter of a century, Quaker City Gear Works has solved thousands of them and produced millions of gears of every description up to 60" in diameter for manufacturers in many diversified industries.

Aircraft controls, dental drills, electric clocks, gauges, indicators, heat controls, machine tools, radar, radios, washing machines and motion picture projectors are but a few of the many conveniences of modern progress which depend upon the heartbeat of Quaker City Gears. Your gear problem is our business, our large productive capacity is at your service.

YOUR INQUIRIES WILL RECEIVE PROMPT ATTENTION

The heart of the Outdoorsman Customatic reel illustrated above is but one of many gear trains developed by our engineers and produced in our fully equipped plant.

Quaker City Gear Works

INCORPORATED

1910 N. Front Street, Philadelphia 22, Pa.



In appearance, the sound flashlight resembles the conventional type

changes for different conditions and for relief of ear fatigue. Experimenters noticed that sound at frequencies below 10 kc attracted considerable undesired attention from bystanders.

Beam widths between 12 and 30 degrees (depending on frequency) are possible with the reflector which is 4 inches in axial length and 4 inches in diameter at the mouth. The reflector is made of spun aluminum covered with papier maché.

The headphone transducer is mounted at the focal point of the reflector. It is insulated from the metallic reflector by a layer of sponge rubber and held in place by rubber cement and papier maché. A male plug is embedded in the rear of the horn for connection of the extension cord from the oscillator which is carried in a pocket.

To reduce the intensity of the sound reaching the user caused by leakage around the rim, baffles of cotton and sponge rubber are used with only slight reduction in the intensity of the main lobe.

Although the sound flashlight was designed primarily as an obstacle detector, skilled operators

SPECIFY THIS TUBE

for h-f heating equipment to do these jobs—

Seal, stitch, and join plastics and various other substances

Braze—quick-solder—set glues by heat conduction

Surface-harden or anneal small metal parts

Defrost and cook foods electronically

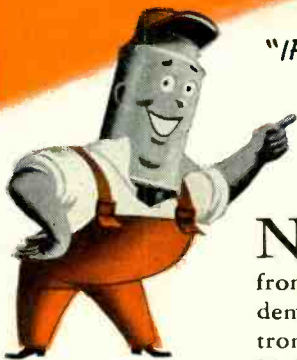

"IF YOU MANUFACTURE SMALL ELECTRONIC HEATERS, YOU'LL FIND TYPE GL-592 THE RIGHT OSCILLATOR OF LATEST DESIGN—POWERFUL, COMPACT, ECONOMICAL, LONG-LIVED!"

NATURALLY you want to profit from the zooming demand for electronic heaters for high-speed repetitive work. And knowing it's the oscillator tube that makes or mars performance, you intend to be extra-careful about tube high frequency—ample capacity in watts—reliability that users can bank on—availability you can bank on!

These qualities are packaged in Type GL-592. The tube already is in service, helping to speed plant output. Stocks are on hand to meet your requirements, and sockets, grid connectors, finned anode connectors, all are available. *Specify and install...* there'll be no lag between the two!

That high frequency ceiling (150 mc at full ratings) means Type GL-592 will handle easily the up-to-70-mc requirements of bench dielectric heaters, not to

mention lower-frequency induction work: The tube carries substantial plate ratings, and if still more power is desired, a pair or two pairs may be employed without prohibitive increase in cost or size of the equipment. Conversion efficiencies above 70 percent are routine for the GL-592 in properly designed circuits. Cooling calls for merely an 8-inch household-type fan, or a small and inexpensive pressure blower.

The tube is sturdy—cathode, grid, and anode are solidly mounted and braced. All leads are short. Fernico metal-to-glass seals mean (1) no cemented caps or bases with the dielectric losses these entail, (2) no soft-soldered leads or terminals to come loose.

Get further facts about this modern, efficient, tough triode—including the favorable price—from your nearby G-E electronics office! Or wire or write *Electronics Department, General Electric Company, Schenectady 5, New York.*



GL-592 Power Triode

Ratings, Class C Power Amplifier and Oscillator

Filament voltage	10 v
current	5 amp
Max ratings:	CCS ICAS
d-c plate voltage	3,500 v 3,500 v
d-c grid voltage	—500 v —500 v
d-c plate current	250 ma 350 ma
d-c grid current	50 ma 100 ma
plate input	670 w 1,000 w
plate dissipation	200 w 300 w
Type of cooling	forced-air
Frequency at max ratings	150 mc

The G-E line of power triodes for electronic heating is complete, covering every need and application. Tube types range in max plate voltage from 2,000 v to 20,000 v—max current, from 250 ma to 10 amp—max dissipation, from 125 w to 100 kw. Prices and details on any or all types will be supplied at your request.

GENERAL ELECTRIC

161-G30-8850 7

FIRST AND GREATEST NAME IN ELECTRONICS



MOSINEE

"More than Paper"

In the field of electronics and the electrical goods industry, MOSINEE stands for paper-base processing materials with scientifically controlled chemical and physical properties, high quality standards and dependable uniformity... with good dielectric strength, high tensile or tear strength; proper softness or stiffness; creped with controlled stretch or flexibility; specified pH for maximum-minimum acidity or alkalinity; accurate caliper, density, liquid repellency or absorbency... or other technical characteristics vital to your quality standards and production requirements.

MOSINEE PAPER MILLS COMPANY • MOSINEE, WIS.

"Essential Paper Manufacturers"

TUBES AT WORK

(continued)

have been able to detect slight depressions by directing the beam so that it makes an angle of about 60 degrees with the ground. The device is most successful, however, in detecting such obstructions as trees, lamp posts, parked vehicles, hedges, flights of stairs leading up, and open doorways.

Preliminary tests showed that detection was possible at distances up to and greater than 30 feet, depending on the number of obstacles present, the prevailing acoustical conditions and the user's experience and proficiency.

RADAR-EQUIPPED LINER BERTHS IN FOG

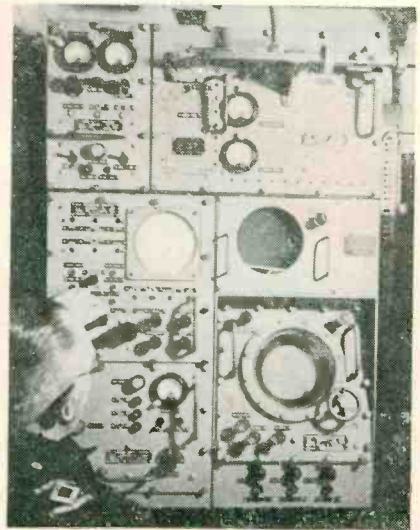

Radar installation in iron hutch atop navigation bridge of 20,000-ton Canadian Pacific line's "Empress of Canada" with plan position indicator screen just above operator's head. Repeater tube is located on navigation bridge for use by captain and pilot, who keep in contact with the trained radar operator by telephone when interpretation of complex patterns is required.

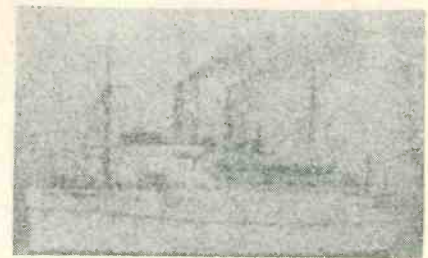

View of "Empress of Canada" running into fog in the Mersey. This ship recently came into Liverpool harbor in total fog and reached her berth entirely by radar. The landing stage could be seen by the crew only after they had gone half-way down the gangplank. The ship is fitted with British Admiralty type 268 radar.



We've got our eye on **your** assembly line

... to help you
speed production

When we build cabinets, housings or enclosures for you, we plan and work with the objective of saving you time, labor and extra operations on your production line.

Karp-constructed units are handsome and streamlined, but their beauty is more than skin deep. The extra value our work affords is a degree of quality, accuracy and precision that will speed up your assembling operations.

You will find all units completely uniform in every detail, all measurements exact, all holes the right size

and cleanly drilled, all openings precisely spaced, all welding skillfully done with finest equipment.

As a result, in your assembling, all functional parts, instruments and controls will fit correctly and easily into place. Installation operations will be smooth and speedy. You will encounter no delays for any completion details. This saving of time and labor will cut your costs. Your completed assemblies will have added market value, too. In short, Karp custom craftsmanship will prove less expensive in the long run.

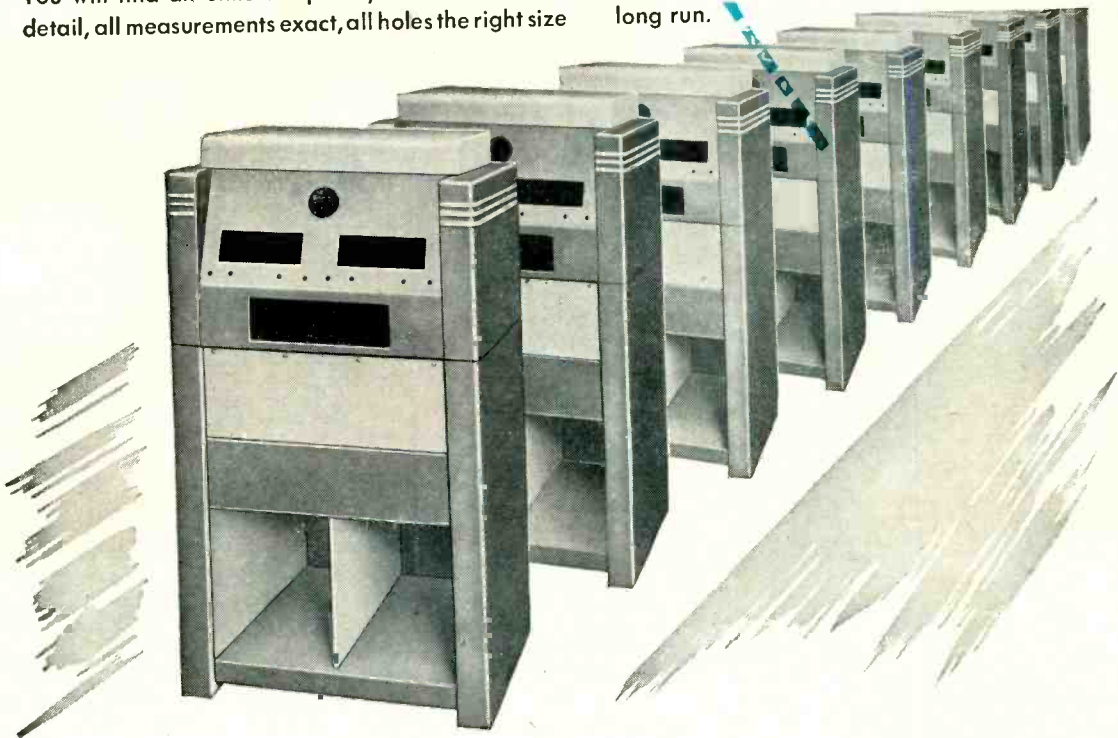

KARP METAL PRODUCTS CO., INC.

215-63rd STREET, BROOKLYN 32, NEW YORK

Custom Craftsmen in Sheet Metal



*as Quickly
as Simply*

.. as putting the cap on your fountain pen .. you change Cartridges in Astatic's FL-33 PICKUP to 78 RPM RECORDS

No tools needed ..
No changing of needle pressure
.. Nothing else to do!



UNPARALLELED quality of reproduction of Columbia Microgroove Records is not the only advantage of Astatic's FL-33 Pickup. This new achievement of Astatic precision manufacture offers superior utility and convenience as well. Produced to Columbia's own specifications, its LP-33 Crystal Cartridge is easily, instantly replaceable with the new LP-78 Cartridge for playing conventional 78 RPM Records. No tools are needed, no adjusting of needle pressure, there is nothing else to be done. Identical in appearance, the cartridges are designed for insertion in the FL Arm on the same slip-in principle with which the modern fountain pen secures itself in its cap. The LP-78 Cartridge has a permanent sapphire needle with .003-inch tip radius, as compared with the .001-inch tip of the LP-33. Check the accompanying detailed features. Write for further information.

**FEATURES
OF
ASTATIC'S
FL-33
PICKUP**

1. Five-Gram Needle Pressure.
2. Permanent Sapphire Needle with .001" Tip Radius.
3. Approximately One-Half Volt Output.
4. Frequency Range 30 to 10,000 c. p. s.
5. Novel Design at Base Eliminates Tone Arm Resonances and Assures Perfect Tracking.
6. LP-33 Cartridge for Microgroove instantly replaceable in FL Arm with LP-78 Cartridge having .003" radius needle for playing 78 RPM Records. Both simply slip into position, no tools needed, NO CHANGING OF NEEDLE PRESSURE.

FL FILTER—For best performance with high quality speakers. Controls high frequency response.

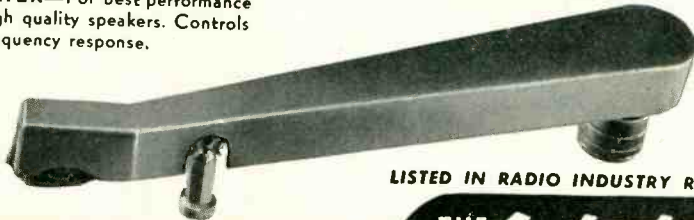

LISTED IN RADIO INDUSTRY RED BOOK



Astatic Crystal Devices Manufactured Under Brush Development Co. Patents

THE ELECTRON ART
(continued from p 126)

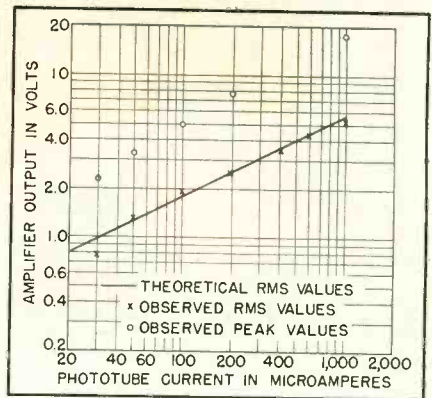

Agreement of observed and theoretical rms noise voltages indicates that, over the measured range, shot effect is the only important contribution to the noise output of vacuum phototubes

statistics, which gives $\delta = N_o^{-1/2}$ where N_o is the average number of electrons emitted in the interval T seconds. The mean fluctuation Δ is equal to the product of the mean relative fluctuation and the average number of electrons emitted during the interval, or $\Delta = N_o^{1/2}$. This result implies that the random variation in phototube current (noise) is proportional to the square root of the phototube current, if every electron that is emitted by the cathode reaches the anode.

When a phototube provides the input signal to an amplifier, the output of the amplifier consists of the shot noise from the phototube and the thermal noise from the input resistance of the amplifier, assuming that subsequent stages in the amplifier contribute relatively negligible noise. If the characteristics of the amplifier are known, the noise contribution of the phototube can be calculated from the measured noise output.

Effect of Amplifier

The mean-square voltage across the output terminals of an amplifier is given by³

$$V_N^2 = 2ei \int_0^\infty Z^2 G^2 df$$

in which V_N is the rms noise voltage, e the charge on an electron (1.59×10^{-19} coulomb), i the phototube current in amperes, Z the phototube coupling impedance in ohms, G the voltage gain of the amplifier, and f is frequency in cycles per second. Inasmuch as G is a function of frequency, this

STUPAKOFF

KOVAR-GLASS TERMINALS

Give Permanent....

Hermetic.... Pressure-tight Seals

Stupakoff hermetic seals are the answer where products must have permanently vacuum- and pressure-tight insulated electrical lead-ins. They seal against atmosphere, dirt, dust, fungus, and other foreign substances that normally cause failures.

Available from stock or specially made to suit your needs, Stupakoff metal-glass seals can be supplied

with single or multiple, hollow or solid electrodes.

The metal Kovar is available in sheets, rod, wire, tubing and special shapes for manufacturers having glass working facilities.

We will gladly send literature, recommendations and prices on your hermetic seal requirements. Write today.

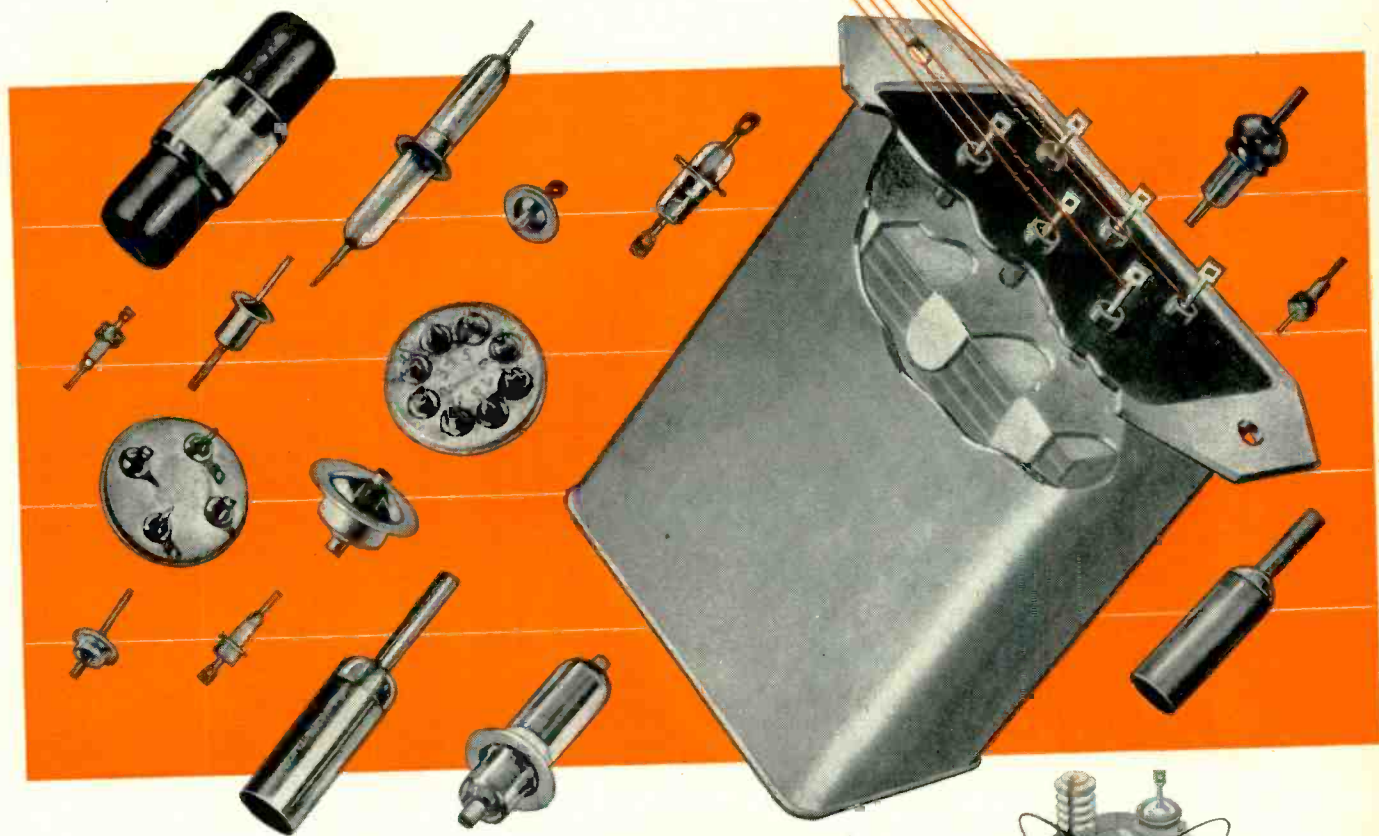

Write for literature.

STUPAKOFF

CERAMIC AND MANUFACTURING CO.

LATROBE, PENNSYLVANIA
Cable Address: Stupakoff, Latrobe, Pa.

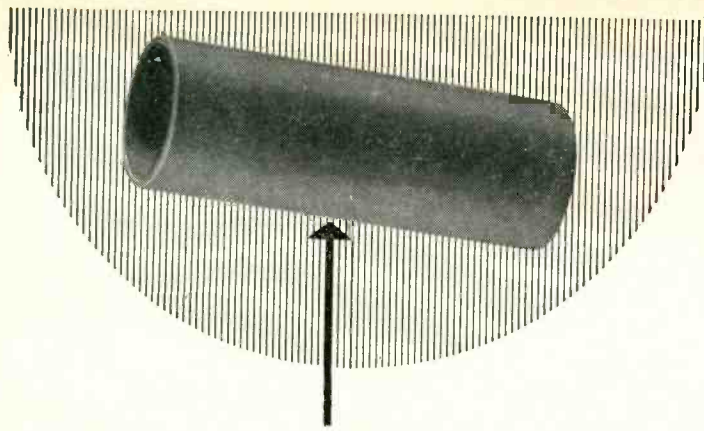

WANT TO MAKE SOMETHING OF IT?

Pictured above is a tube of Taylor Laminated Phenol Fibre, just as it comes from our production line.

Pictured below is a coil form . . . quickly fabricated from this same tube. Note the precision of the punching and threading.

Sheets, rods, and tubes of Taylor Laminated Plastics possess so many properties, physical and electrical, of interest to industry . . . and adapt themselves to such a variety of fabrication processes . . . that their usefulness grows and grows and grows.

If you want a dependable source of supply for Phenol Fibre, Vulcanized Fibre, or special laminates . . . or if you're interested in having completed parts or sub-assemblies delivered on schedule at your plant . . . get in touch with Taylor. Send a sketch or blueprint, if you will, and we'll tell you exactly what we can do for you. Expect plenty; you won't be disappointed.

TAYLOR FIBRE COMPANY

LAMINATED PLASTICS: PHENOL FIBRE • VULCANIZED FIBRE • Sheets, Rods, Tubes, and Fabricated Parts
NORRISTOWN, PENNA.

Pacific Coast Plant: LA VERNE, CAL.

Offices in Principal Cities

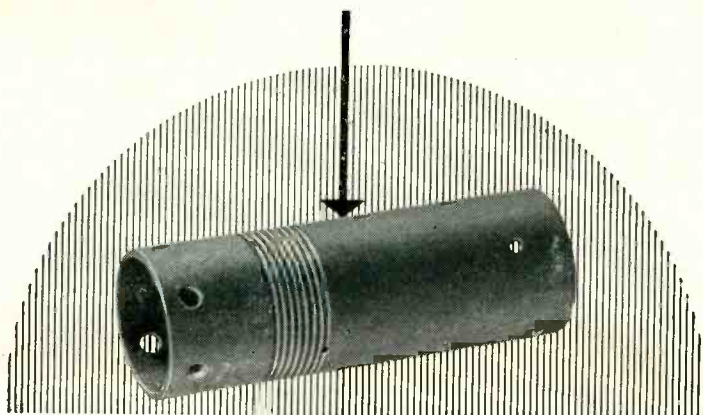

equation indicates that the noise output is proportional to the square root of the amplifier bandwidth. The noise due to the amplifier can

Effective Noise Bandwidth of Tuned Amplifiers

Number of stages	Bandwidth factor
1	1.57
2	1.22
3	1.15
4	1.13
5	1.11
6	1.10
infinity	1.06

Effective noise bandwidth of an amplifier consisting of cascaded, independent, identical, single-tuned pentode stages is the product of the overall half-power bandwidth of the amplifier and the above bandwidth factor for the appropriate number of stages

therefore be reduced by making the pass band of the amplifier as narrow as other design considerations permit.

Usually in computing the noise contribution of an amplifier, the bandpass characteristic, including the skirts out to -6 db of the midband transmission, is measured and the frequency-gain area corresponding to a rectangular bandpass obtained to simplify the calculation. A rigorous approach⁴ shows that the noise bandwidth equals the overall half-power bandwidth of the amplifier times a factor which is a function of the number of stages, as given in the table. This bandwidth factor accounts for the skirt shape and indicates that increasing the number of identical stages, up to about three stages, produces an appreciable reduction in equivalent noise bandwidth for circuits of fixed selectivity. On these considerations an amplifier consisting of three tuned stages with a cathode follower output was built. A peak gain of approximately 9×10^4 at 395 kc was obtained.

Experimental Method

The input circuit to the amplifier consisted of the phototube and its load resistor in parallel with the amplifier input impedance. The coupling impedance Z was measured to be 21,000 ohms to within 5

YOUR PRODUCT, TOO

CAN BE RADIO NOISE-PROOFED WITH C-D

Quietones
Reg. U.S. Pat. Off.

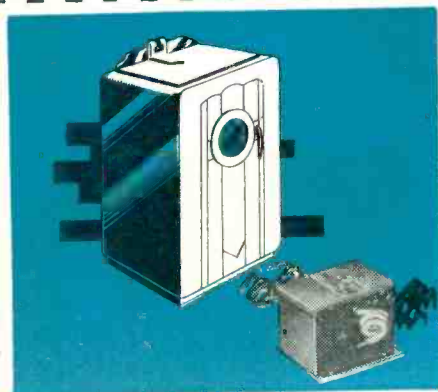
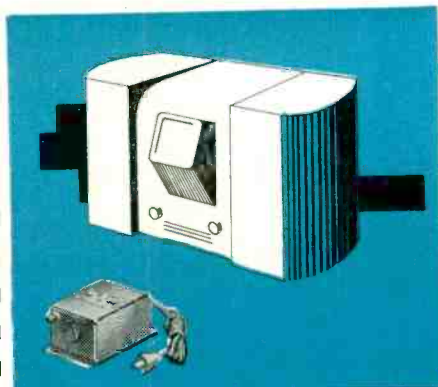
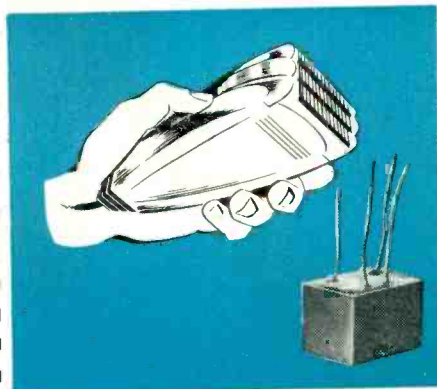
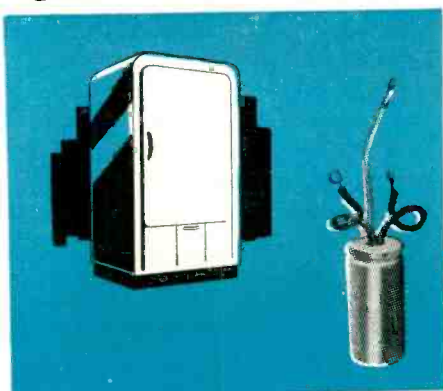

When we say Radio Noise-Proofed—we mean Radio Noise-Proofed. It's no trick at all to build a filter with high attenuation at 150 kc or 100 mc . . . but to build one which filters at 150 kc and 100 mc—as well as all points in between—is a horse of a different color. We know because we've done it. It is only one of hundreds of available types of C-D Quietones designed for all standard requirements.

Among these stock types there may be one which will bring the interference level of your product down to the level of a rabbit's bark. If not, we invite you to make full use of our Radio noise-proofing laboratory and our engineers for the development of a unit designed for your specific needs.

Your inquiries are cordially invited. Address: Cornell-Dubilier Electric Corporation, Dept. K-11, South Plainfield, N. J. Other large plants in New Bedford, Worcester and Brookline, Mass., and Providence, R. I.

Make Your Product More Saleable
With C-D Quietone Radio Noise
Filters and Spark Suppressors

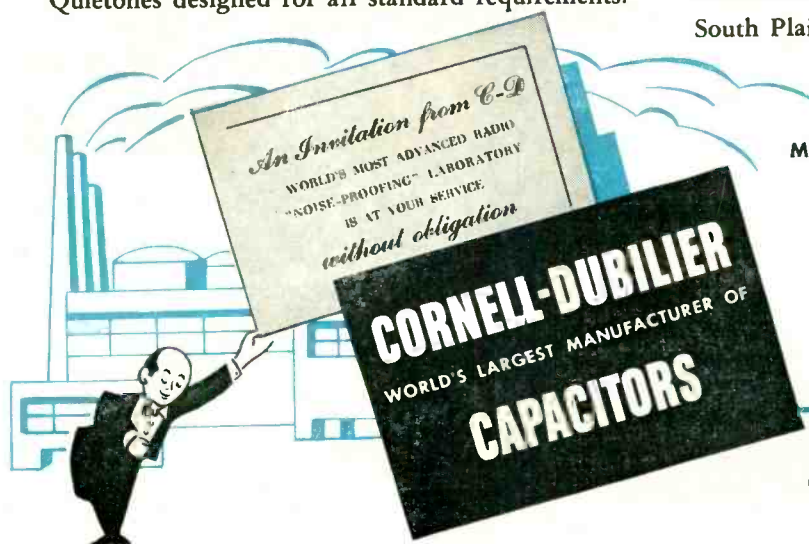

MICA • DYKANOL • PAPER • ELECTROLYTIC



What does a RELAY relay?

An Electrical Relay, whatever its style or type, responds to a changing condition in one electrical circuit to cause a change in another electrical circuit.

Wherever electrical energy is used as a controlling agent, SIGNAL ENGINEERING Relays can be applied in a wide variety of uses.

Perhaps you have an electronic circuit where a change in voltage or current requires the switching of several other circuits. The SENSITIVE MULTIPLE CONTACT PLUG-TYPE RELAY, illustrated at right, is designed to meet just such a condition and offers up to 6 pole, double throw, with a 20 point plug. A.C. or D.C. Ask for Bulletin 50-6.

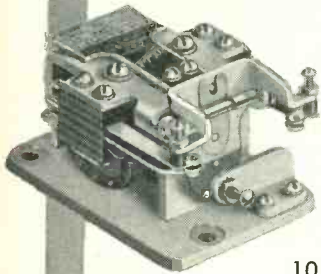
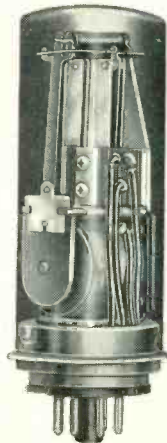

OR

A keying circuit or pulsing circuit where rapid response and low current drain are required characteristics. The SERIES 10 AND SERIES 20 RELAYS are fast, sensitive, shockproof and are adaptable to many contact arrangements. Bulletin KR1-6.

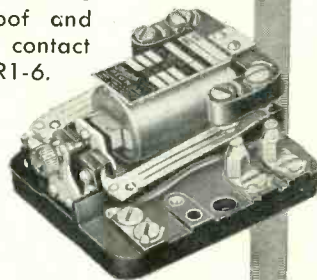

OR

The need for a small, rugged, POWER RELAY, double pole, double throw, without pigtailed, for operation of bells, horns, lamps, small motors, etc. Write for Catalog 6-6.

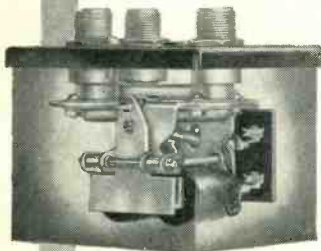

OR

An application requiring a high frequency COAXIAL CABLE RELAY, with correctly designed, low loss circuit, available with A.C. or D.C. actuating coils. Bulletin CR1-6.

SIGNAL ENGINEERING and MANUFACTURING COMPANY

154 WEST 14th ST. NEW YORK 11, N. Y.

THE ELECTRON ART

(continued)

percent; this impedance can be considered constant over bandwidth.

The phototube used in these measurements was a GE 1P24. Several tubes were tested and little difference between them was found.

The output voltage from the amplifier was measured by two methods: a vacuum thermocouple with a 3,000-ohm resistor in series indicated the rms value of the output, while a vacuum-tube voltmeter was used to measure peak voltage. (The vtvm was a peak reading instrument calibrated in rms value of a sine wave, which is 0.707 of the peak. Therefore the actual meter readings were multiplied by 1.414 to obtain peak values.) The thermocouple output is fed to a galvanometer. The combination was calibrated at 395 kc and checked at 300 and 500 kc, at which frequencies the calibration was little changed from the center-frequency value.

Theoretical values of the noise output of the amplifier were obtained from the foregoing equation using the measured value of Z . The expression

$$\int_0^{\infty} G^2 df$$

was evaluated by numerical integration of the measured response of the amplifier, with squared ordinates. Substituting the numerical values in the equation for noise gave $V_N^2 = 3.0 \times 10^4 i$ square volts, where i is the phototube current.

Theoretical and observed values for V_N are shown in the graph. Observed values were corrected for residual amplifier noise by means of the relationship

$$V_N = (V_o^2 - V_R^2)^{1/2}$$

where V_o is the measured amplifier output voltage with noise signal from the phototube applied and V_R is the residual noise with no applied signal. The residual noise amounted to about 0.3 rms volt. The close agreement between theoretical and observed values indicates that other sources of noise contribute very little to the noise output.

Observed peak values are also plotted on the graph. The peak voltage is about three times the rms value. This represents considerable departure from sinusoidal waveshape for which the peak value is 1.414 times the rms value. (Something about the impulse waveform



Exclusive Manufacturers of Communications Network Components

TOROIDAL COIL FILTERS AND TOROIDAL COILS DESIGNED FOR CRITICAL APPLICATIONS

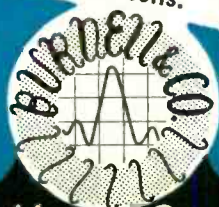
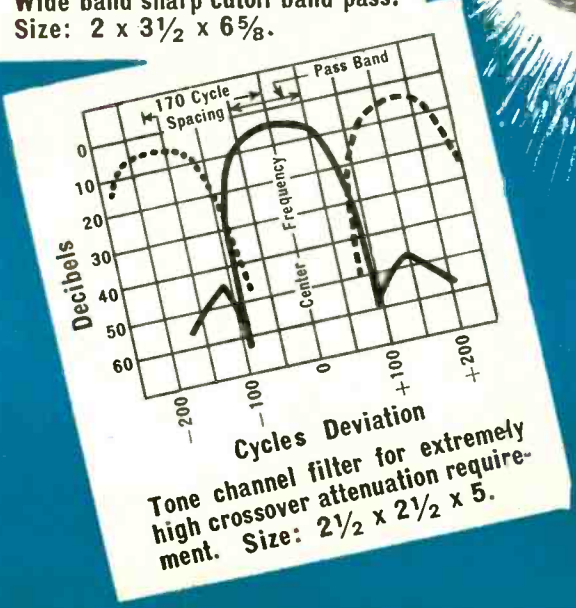
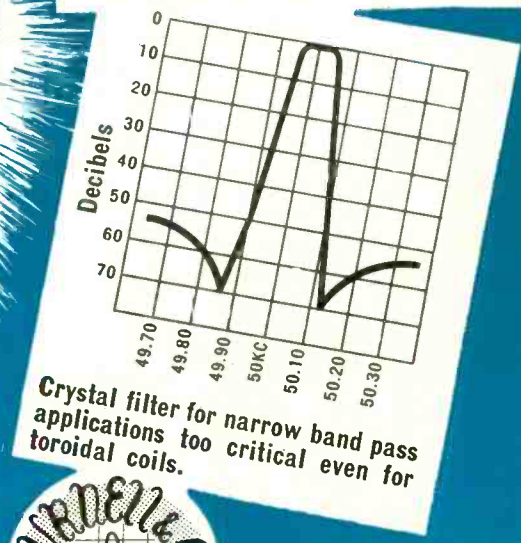
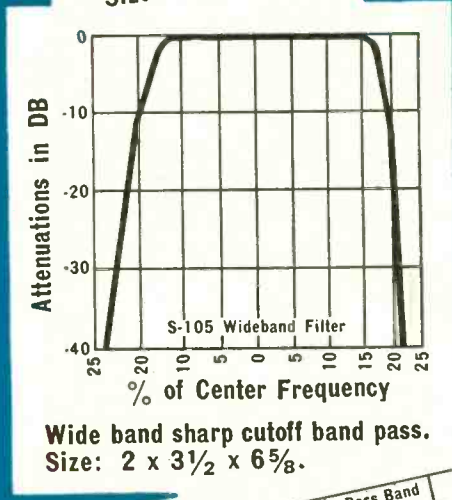
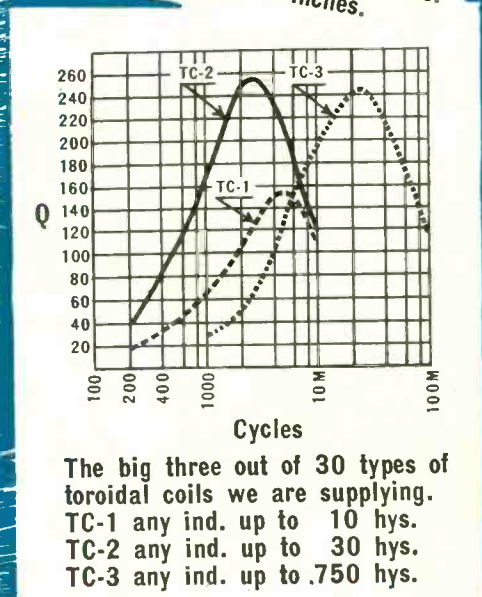
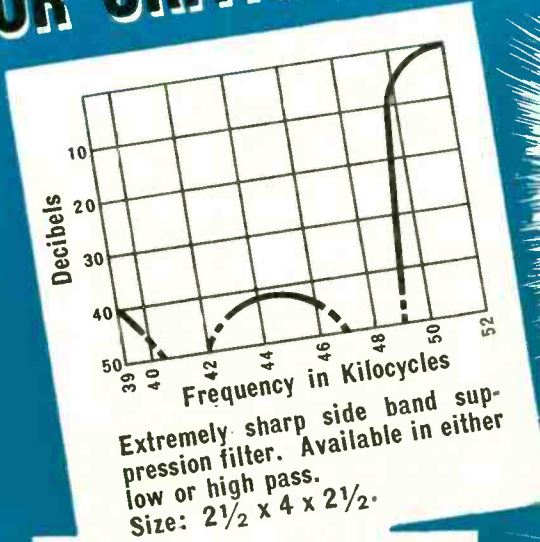
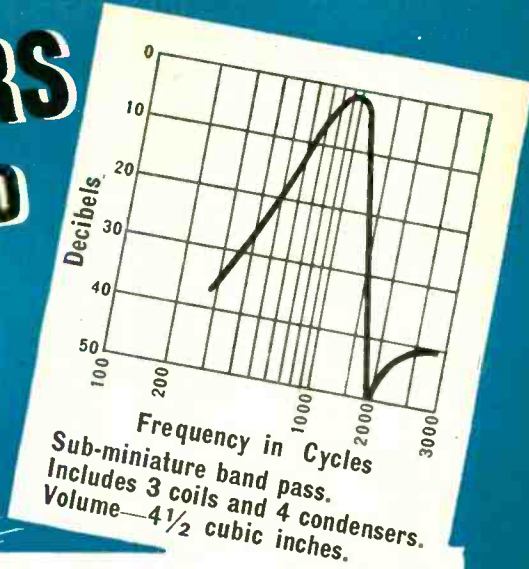

Burnell & Company
YONKERS 2, NEW YORK
CABLE ADDRESS "BURNELL"

ALL INQUIRIES WILL BE PROMPTLY HANDLED . . . WRITE FOR TECHNICAL INFORMATION

FOR THE NEW TELEMETERING BAND

Bendix Pacific MODEL TXV-2A TRANSMITTER

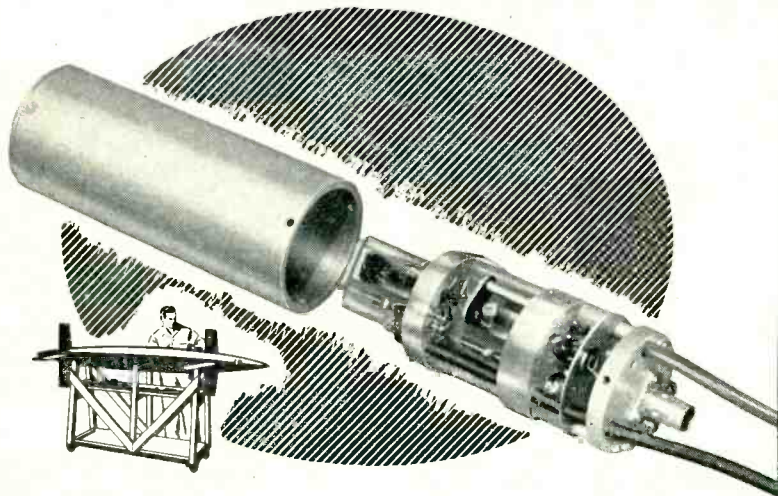

The Bendix Model TXV-2A Transmitter is a VHF direct FM transmitter developed to supplement a complete line of telemetering components designed for use in the FM/FM subminiature telemetering system.

Complete telemetering facilities are available at Bendix Pacific including not only the manufacture and supply of components, but also installation and application engineering, field operations, data reduction and engineering consultation.

SPECIFICATIONS

Frequency range: 209 mc to 227 mc
 Modulation: to ± 125 kc
 Power required: 135 volts at 40 ma and 6 volts at 0.45 amp.
 Nominal output: 0.5 watt into 51.5 ohms
 Weight: .875 pounds
 Case Dimensions: 2 inches in diameter— $5\frac{1}{8}$ inches long
 (excluding connectors)

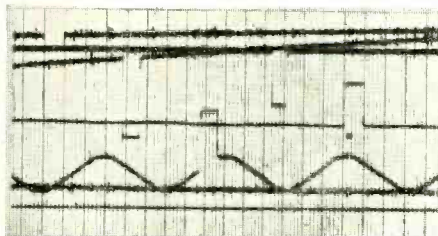

DATA REDUCTION

Additional information on the TXV-2A Transmitter or other telemetering components or services is available upon request from qualified companies.



Pacific Division
 Bendix Aviation Corporation
 NORTH HOLLYWOOD, CALIF.

East Coast Offices: 475 Fifth Ave., New York 17, N.Y.

of the noise could be inferred from this factor of three, but would have little significance without further measurements.)

Conclusions

From these observations it is concluded that the noise output from vacuum phototubes is almost entirely due to shot effect for currents up to at least one milliamper, and can be calculated simply and accurately. The fact that the peak to rms ratio is higher for the noise signal than for a sinewave is important in applications where the response to peak voltage is being used.

REFERENCES

- (1) A. L. Hughes and L. A. DuBridge, "Photoelectric Phenomena," p 34, McGraw-Hill Book Co., 1932.
- (2) B. A. Kingsbury, The Shot Effect in Photoelectric Currents, *Physical Review*, 38, p 1458, 1931.
- (3) J. B. Johnson and F. B. Llewellyn, Limits to Amplification, *Electrical Engineering*, 53, p 1449, 1934.
- (4) Henry Wallman, Stagger-Tuned I-F Amplifiers, *MIT Rad. Lab. Report No. 524*. (The factors for 1, 2, 3, and 4 stages were independently determined by I. Rotkin and P. R. Karr of NBS and reported by them at the October 1947 meeting of URSI in Washington.)

Detecting Displacement

SENSITIVE variable-resistance helical spring transducers are being studied by W. A. Wildhack and his associates at the National Bureau of Standards. The device consists of a gold-coated nickel-alloy wire spring that is wound with high initial tension and so that its elastic constant varies slightly along its length (by varying the winding tension, angle of feed or spring radius). Thus, when the spring is slowly loaded, the turns pull apart one by one rather than simultaneously. When the spring is entirely closed, it has a low electrical resistance from end to end because of the low contact resistance of the gold plating; as it is loaded, the resistance continuously increases. The percentage change in resistance can be hundreds of times greater than the percentage change in length. Displacements of 0.0001 inch can be measured without electrical amplification by this highly sensitive and versatile method that is applicable to strain gages, pres-

ALSiMAG

TRADE MARK REGISTERED U.S. PATENT OFFICE

a superior, low cost
alternate for many
commonly used materials



Example: A manufacturer replaced a machined part which cost him 33 cents each with an improved ALSiMag component which cost 14 cents each. ALSiMag engineers cooperated in redesigning this component for maximum usefulness to the customer and minimum production cost—That same engineering cooperation is available to you on request.

● Engineers are often surprised to find that metal, plastic or wood parts can be replaced with ALSiMag components at a saving in cost. At the same time they usually gain highly desirable advantages in product performance. It is natural that a product with the many superior advantages of ALSiMag would be expected to be expensive. The basic materials in ALSiMag are costly.

Automatic and efficient manufacture permits quantity production of ALSiMag parts at low prices. Thus, ALSiMag prices are frequently lower than prices of similar parts in cheaper materials which are more expensive to fabricate.

ALSiMag technical ceramic components are custom made for the individual requirement. ALSiMag is the trade name of a large number of ceramic compositions. The physical characteristics of the various compositions are clearly and accurately listed in the ALSiMag Property Chart, sent free on request.

Our engineers will be glad to submit suggestions on design and give you information on cost if you will submit details of your requirements.

47TH YEAR OF CERAMIC LEADERSHIP

AMERICAN LAVA CORPORATION

CHATTANOOGA 5, TENNESSEE

SALES OFFICES: ST. LOUIS, MO., 1123 Washington Ave., Tel: Garfield 4959 • NEWARK, N. J., 671 Broad St., Tel: Mitchell 2-8159 • CAMBRIDGE, Mass., 38-B Brattle St., Tel: Kirkland 4498 • CHICAGO, 9 S. Clinton St., Tel: Central 1721 • LOS ANGELES, 324 N. San Pedro St., Tel: Mutual 9079 • PHILADELPHIA, 1649 N. Broad St.

WHY...

COLLINS RADIO COMPANY
chose STANDARD'S Crystal-Type 20
for their "new vhf navigation receiver"

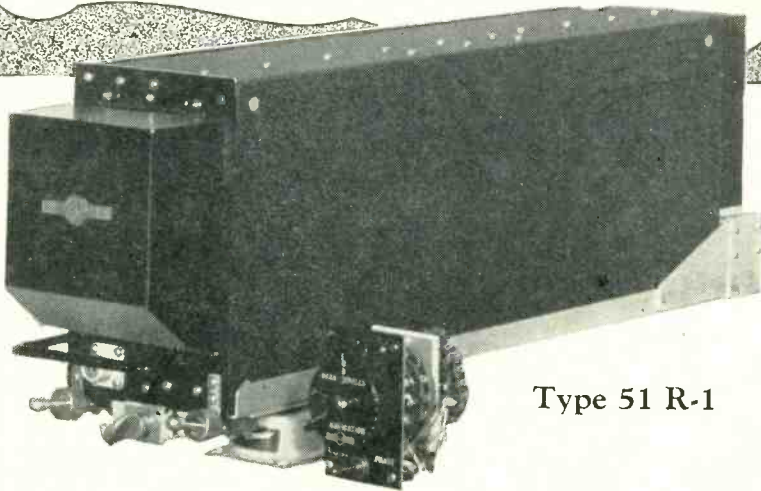

Type 51 R-1

PROBLEM

To build a receiver intended for airline and military service in the vhf navigation and communication bands. Compactness and elimination of extra weight dictated use of a crystal that is light in weight, hermetically sealed and highly stable.

SOLUTION

STANDARD'S Crystal-Type 20



REASONS

(as stated by Collins Engineering Department)

- (1) Standard's Type 20 meets $\pm .005\%$ stability requirement over -55°C to $+90^{\circ}\text{C}$ range and is hermetically sealed in dry nitrogen.
- (2) Low price for required performance.
- (3) Best volume and shape factor.
- (4) Standard's Type 20 proved consistently superior in stability and activity.

Let us send you our FREE catalog showing the STANDARD line of frequency control units. For special problems, our engineering department is at your service. There's no obligation involved.

(We manufacture quality super-sonic and ultra-sonic crystals.)

STANDARD PIEZO COMPANY

Office and Development Laboratories

CARLISLE - PENNSYLVANIA

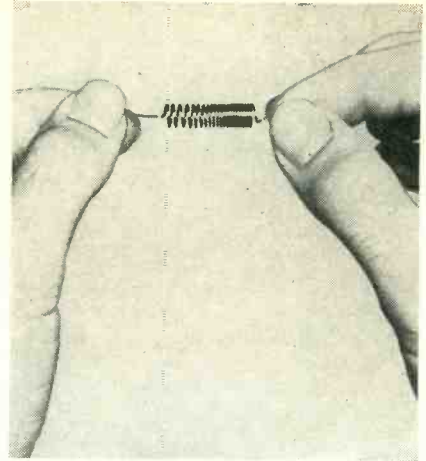

Basis of sensitive mechano-electrical transducer is progressive separation of turns under increasing tension. Unloaded resistance is that of a solid cylinder because of low contact resistance between gold plating on coils and high average initial tension of the spring

sure elements, accelerometers, weighing devices, temperature controllers, and other measurements involving changes in dimensions. The preferable construction for a transducer using such springs is a four-arm bridge in which a displacement elongates one pair and shortens the other pair of springs. Measurements with this circuit are reproducible to one percent.

Reducing Hum in Pentodes

By IMRE ZAKARIAS

*Picofarad Elektromos Meroberendezesek
Budapest, Hungary*

USING SCREEN-GRID TUBES for amplifying low-level signals of the order of ten microvolts having frequency components in the band from 0.5 to 200 cycles per second, as in equipment for electrocardiography and electroencephalography, is troublesome because of the residual hum from the alternating current used in the heaters, despite screening, filtering, and grounding of the cathode. Tests show that this heater hum varies with tube type and between individual tubes of the same type. To find means for counteracting this source of hum, measurements were made which showed the effectiveness of the several alternatives.

Sources and Measurement of Hum

If there is a potential difference between cathode and heater, as in

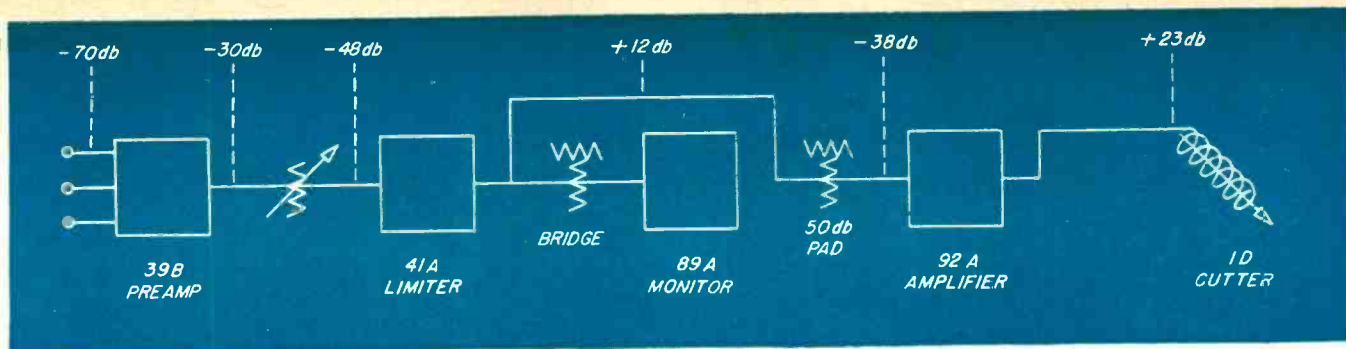

You're sure

WHEN IT'S 100% PRESTO

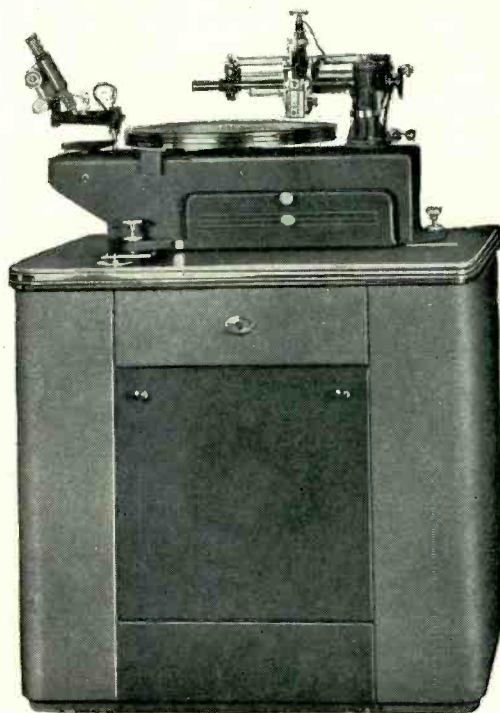

Pictured here is an all-Presto single channel recording system. Above is the block diagram, worked out for this equipment by Presto engineers.

WHEN YOU NEED recording or transcription equipment you can't go wrong if you make the complete system 100% Presto.

For Presto is the world's foremost manufacturer of recording and transcription equipment and discs. And Presto's experience with countless installations, including all the big ones, will aid you in achieving greater efficiency and trouble-free operation.

The recorder is the 8DG with direct gear drive. The amplifiers are the 39-B three channel preamp, the 41-A limiter, the 92-A 60 watt recording amplifier, and the 89-A monitor.

Multiple channel installations consist of as many duplications of the basic channel as are needed with the addition of switch or patching facilities. When you think of recording, think of PRESTO.

PRESTO

RECORDING CORPORATION

Paramus, New Jersey

Mailing Address: P.O. Box 500, Hackensack, N. J.

In Canada: WALTER P. DOWNS, Ltd., Dominion Sq. Bldg., Montreal

WORLD'S LARGEST MANUFACTURER OF INSTANTANEOUS SOUND RECORDING EQUIPMENT AND DISCS

NEW SHURE "900MG"



Gives Maximum Reproduction of Micro-Groove Record Fidelity

The Shure "900MG" Pickup is an ideal instrument for tracking on the new micro-groove records. It tracks at 6 grams . . . uses a special offset osmium-tipped needle with a point radius of only .001" . . . and has an output of 1 volt! The Shure lever system has been adapted in the development of this new pickup—providing a high needle compliance. Listen to it—you will be thrilled with the results!

Model "900MG"

Code: RUZUZ

Shure Patents Issued and Pending. Licensed under the Patents of the Brush Development Co.



SHURE BROTHERS, Inc.

Microphones and Acoustic Devices

225 W. HURON ST., CHICAGO 10, ILL. • CABLE ADDRESS: SHUREMICRO

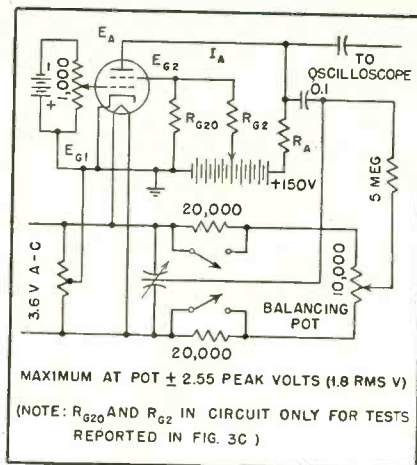

FIG. 1—Experimental circuit for measuring hum produced by heater current

self-biased circuits and in which case the cathode is not grounded, a portion of the hum can arise from leakage currents between heater and cathode. But usually the hum results from the fluctuations of the current distribution between screen grid and plate caused by the deflection effect of the alternating magnetic field of the heater current. Tests in which the tube was heated by direct current and an auxiliary alternating potential of six volts was applied between heater and cathode, with the cathode grounded, showed no hum. Also, the hum disappeared when the screen was connected directly to the plate, with a-c heating. Furthermore, the hum was found to be up to 40 fold greater in a variable-mu tube such as an AF 3 (comparable to a 58) compared to a sharp cutoff tube such as the AF 7 (like a 57). It was also observed that the hum varies with the operating point so that varying the control or screen bias can cause the hum to pass through zero, and that an unbypassed screen biasing resistor tends to increase hum whereas an unbypassed cathode resistor tends to decrease it.

In making these measurements of power line hum, the compensating method was used. A voltage, derived from the heater circuit by means of a wired potentiometer, for controlling magnitude, and a differential capacitor, for adjusting phase, was impressed on the plate of the tube under test. The normal operating voltages for the tube were obtained from batteries; Fig. 1

YOU GET QUALITY PLUS ENGINEERING SERVICE WITH G-E PERMANENT MAGNETS

The three G-E permanent magnets shown below produce an automatic braking effect in the new Bristol Electromatic Reel manufactured by the Horton Manufacturing Co., Bristol, Conn.

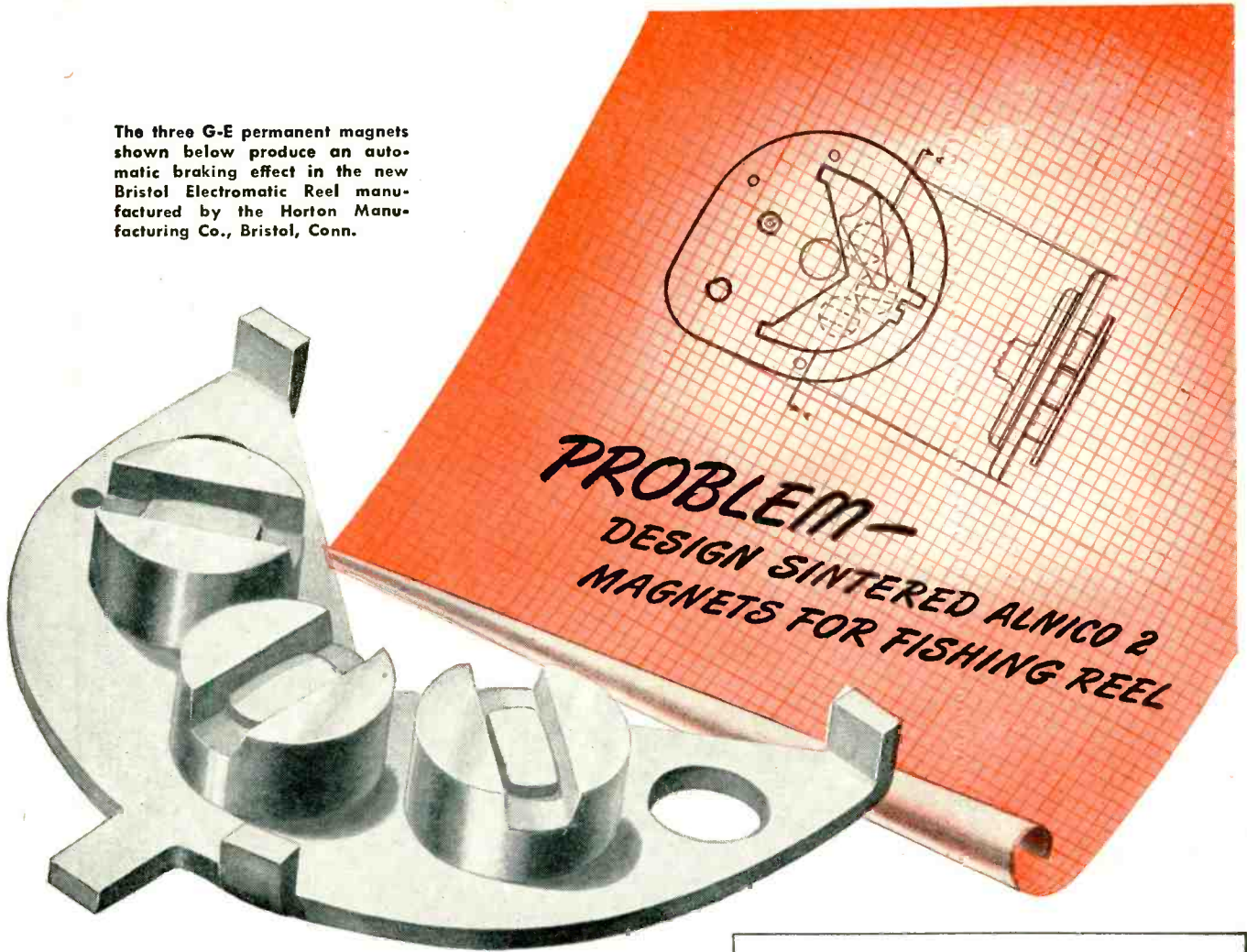

The magnets that brake your reel

Now it's G-E permanent magnets for greater accuracy in casting. The permanent magnets shown above develop a non-friction braking action directly in proportion to the speed of the plug. Maximum braking is applied at the start of the cast and, as the spool is slowing down, the braking effect decreases automatically.

G-E permanent magnets are continually finding wide application in many fields. The magnetic reel is but one example of the adaptation of an industrial magnet engineering principle to an entirely different field.

Perhaps there's a use for G-E permanent magnets in your product. Or, you may wish to improve your present magnet design for greater efficiency. Our engineers will be glad to work with you to improve your product. For details and your free copy of CDM-1, G-E PERMANENT MAGNETS, write Metallurgy Division, Section CM-11, Chemical Department, General Electric Company, Pittsfield, Mass.



**PERMANENT
MAGNETS**

GENERAL  ELECTRIC

CD48-V4

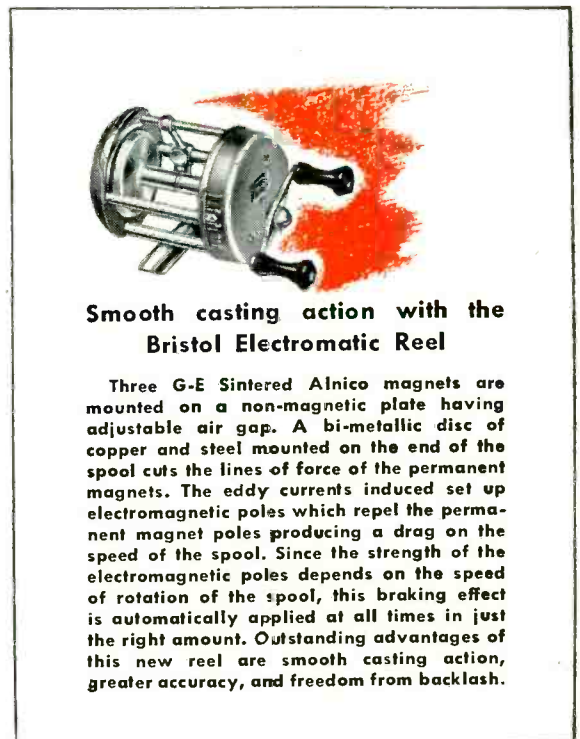

Smooth casting action with the Bristol Electromatic Reel

Three G-E Sintered Alnico magnets are mounted on a non-magnetic plate having adjustable air gap. A bi-metallic disc of copper and steel mounted on the end of the spool cuts the lines of force of the permanent magnets. The eddy currents induced set up electromagnetic poles which repel the permanent magnet poles producing a drag on the speed of the spool. Since the strength of the electromagnetic poles depends on the speed of rotation of the spool, this braking effect is automatically applied at all times in just the right amount. Outstanding advantages of this new reel are smooth casting action, greater accuracy, and freedom from backlash.

Professional
TAPE RECORDING
with FM QUALITY
and EASY PORTABILITY

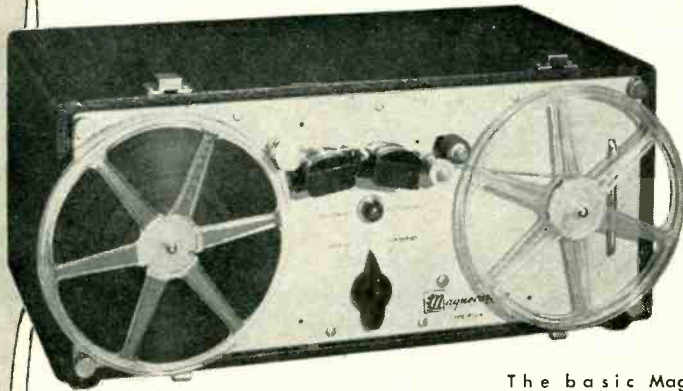

The basic Magnecorder recorder mechanism (PT6-A)

The New 3 Element
MAGNECORDER

The Magnecorder meets the highest broadcast standards, and it costs you less. You buy and combine only the units you need:

Magnecorder (PT6-A) — Basic recorder mechanism.

Portable Mixer-Amplifier (PT6-P) — Recording and reproducing portable field amplifier. Can be used as high-quality remote amplifier. Mixes three low-level microphones.

Rack Mount Amplifier (PT6-R) — Recording and reproducing amplifier for studio rack mounting. With PT6-A makes complete studio recorder-reproducer.

It's Portable! It's Flexible!

Weight — PT6-A, 23 pounds; PT6-P, 29 pounds.

Wow and Flutter — .2%

Frequency Response — 40 to 15,000 cycles; + or - 2 db.

Tape Speed — 15 inches or 7½ inches per second (Interchangeable).

Motor — Synchronous 1/50 HP.

Single Control

Rewind — 45 seconds.

Reels — Standard 7-inch 8MM film reels.

Current failure never throws tape. Instantly interchangeable from portable to rack mounting.

Write today for detailed specifications

Magnecord
 INCORPORATED

360 N. Michigan Ave.

Dept. E

Chicago 1

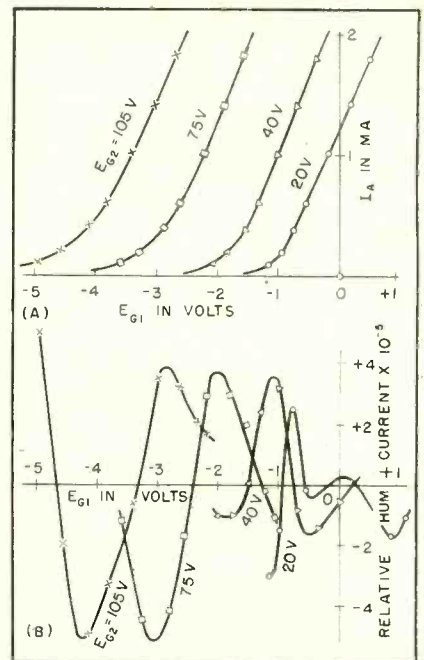

FIG. 2—Characteristics (A) and relative hum current in plate circuit (B) of a sharp cutoff pentode

shows the circuit. Balance in the plate circuit was indicated by a cathode-ray oscilloscope.

Experimental Method and Results

So that absolute values could be obtained, the deflection sensitivity of the oscilloscope and the volts per scale division of the balancing potentiometer were determined. Knowing these factors, the hum can be expressed in terms of alternating current in the plate circuit, or as the ratio of hum current to steady plate current. Shorting the two 0.02-meg resistors in series with the balancing potentiometer increased the compensating voltage by a factor of five. Although the differential capacitor was found necessary to eliminate minor phase shifts, it was observed that, in general, the hum was in phase with the heater voltage.

The results are presented in the form of curves. Figure 2A is the measured characteristic of the AF 7 tube used in the tests. Figure 2B shows the ratio of hum to steady plate current as a function of control grid voltage for four values of screen-grid voltage. Figure 3A shows the same measurements plotted as a function of plate current. In interpreting the effects shown in these last two families of curves,

Product faults found in minutes with MB vibration exciters!

Model C1

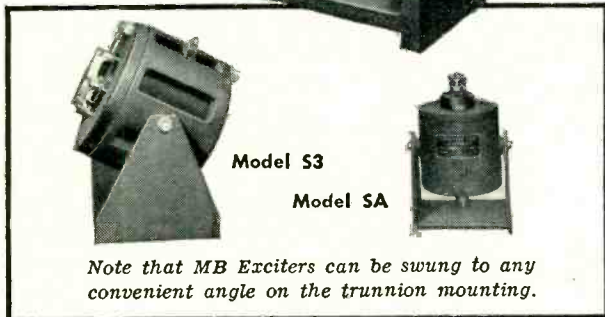

Note that MB Exciters can be swung to any convenient angle on the trunnion mounting.

SOME TIME AGO, a large automotive manufacturer was attempting to learn whether gas tanks could be strengthened.

They first used a mechanical shaker on a test tank in an attempt to discover possible trouble—but days went by without signs of failure. However, when an MB Exciter was attached, the tank was vibrated to destruction in a matter of *minutes!* A repeat test produced a similar failure. Based on the *visual evidence, which eliminated the need for any dynamic computations*, the tank was redesigned, and it was made not only *stronger*, but materially *lighter*—cutting costs as well as saving steel.

In another case, where one manufacturer's headlight bulbs were failing in great numbers, an MB Exciter fixed the blame at once—on the filament supporting arm, which was resonating at a frequency within the operating range of the car.

These cases illustrate a technique of testing that you'll find increasingly valuable as experience shows you new applications for this product improver. MB vibration exciters are now being used by many of the country's largest companies—for fatigue testing, for location of noise sources, for determining the vibratory response of products—and *the corrective measures.*

Would you like to know more about how to use this shaker in your own work? An MB engineer will be glad to give you the benefits of our specialized vibration experience.

If your product has any vibration at all—
this MB VIBRATION PICKUP will detect it!

There's no practical lower limit on the amplitude of vibration you can detect with the MB Vibration Pickup—it's that sensitive! And there's no engine it can't be used on—it's that durable under high-powered pulsations!

It is a velocity-type pickup, electri-

cally damped, with a range of 5 to 1000 c.p.s. and usable in any position. When the pickup's electrical output is fed to standard voltage measuring equipment, it can be used to check products for operating smoothness and for quality-control.



WRITE FOR FREE BULLETINS

Ask for bulletin "Vibration Testing Technique" which describes how MB Exciters are used. And Bulletin 124A will give you more details on Pickup. Write Dep't. D5.

THE

MB

MANUFACTURING COMPANY, INC.

1060 State Street
New Haven 11, Conn.

VIBRATION ISOLATOR UNITS - VIBRATION TEST EQUIPMENT



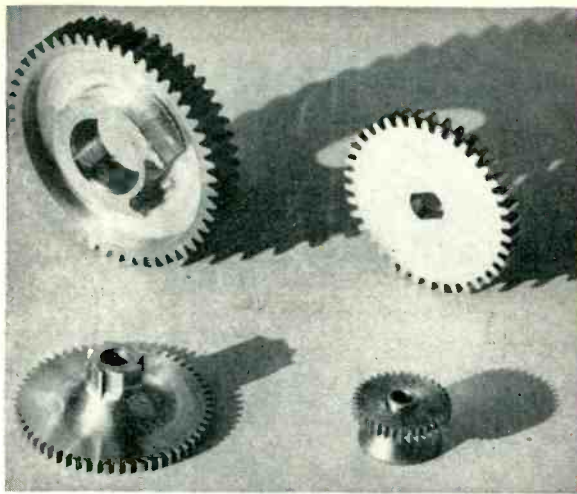

GEARS WITH SHAPES

Special Shapes and Features? . . . Tolerances within .0005" . . . Let our experience in supplying precision small and medium sized gears with such features solve these production problems for you . . . Ask for quotation on your job specifications. Circular on Request.

MEMBER OF



Beaver Gear Works Inc.

1021 PARMELE STREET, ROCKFORD, ILLINOIS

- SPUR
- WORM
- SPLINE
- HELICAL
- SPROCKET
- STRAIGHT BEVEL
- GROUND THREADS

MODEL 204A REGULATED POWER SUPPLY

0-500 VOLTS D.C. AT
300 MA. WITH POSITIVE
OR NEGATIVE GROUND

The Model 204A Regulated Power Supply will provide from 0-500 volts of well regulated and well filtered D.C. The output voltage is continuously variable without switching and either positive or negative side may be grounded.



ELECTRONIC MEASUREMENTS COMPANY
RED BANK • NEW JERSEY

SPECIFICATIONS:

OUTPUT VOLTAGE

High Voltage: 0-500 Volts D.C. continuously variable (Without switching).
Current: 300 Ma.
Low A.C. Voltage: 6.3 Volts A.C. at 6 amps. center-tapped, unregulated

REGULATION

Within 1% for voltage between 30-500 volts, from no load to full load.
Within 1% for line voltage variations from 105 to 125 volts at full load current for any voltage between 30-500 volts and within 2% at 10 volts.

HUM VOLTAGE

Within 10 Millivolts at any voltage or load within ratings.

LINE INPUT

105-125 Volts A.C. 50-60 cycles.

OUTPUT TERMINATIONS

High and low voltage outputs available from front and rear of unit. Positive or negative terminal of high voltage output may be grounded as desired.

Detailed specifications will be forwarded upon request without obligation.

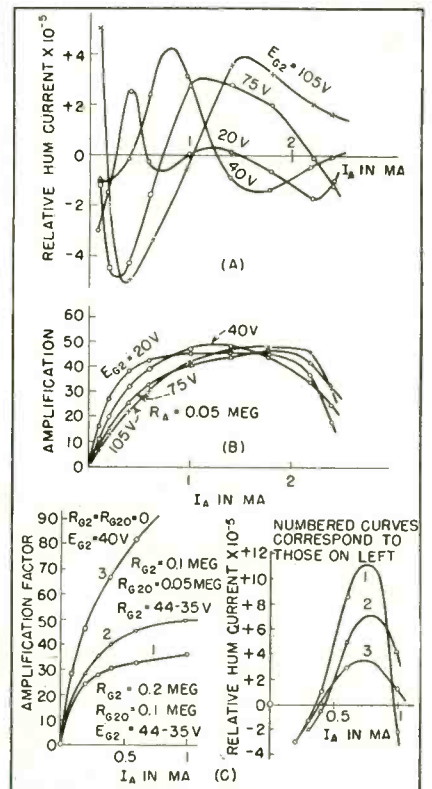

FIG. 3—Results obtained for sharp cutoff tube AF 7 (comparable to a 57)

it is necessary to take into consideration the change in gain produced by the change in grid bias (or plate current). This change is shown as a function of plate current, for use with Fig. 3A, in Fig. 3B. The effect of resistance in the screen circuit is shown by the two sets of curves in Fig. 3C; those to the left show change in gain, those to the right show relative hum, both as functions of plate current.

Comparing Fig. 2A and 2B it can be found that the equivalent hum amplification factor of the screen grid is 34 compared to 27 for the anode current amplification factor. This greater amplification factor for the hum is also evident from Fig. 3A. Figure 3C shows that, as the unbypassed screen resistance is increased, the hum increases and the gain decreases. The screen-grid voltage varies somewhat with plate current therefore the curves are not fully comparable. At plate currents below 0.4 ma the amplification factor is small so that the screen degeneration is negligible and the curves are therefore identical.

Figure 4 shows measurements on an AF 3; Fig. 4A shows the hum, Fig. 4B shows the gain. From Fig.

Where cables can't go



TIME SHARING MULTIPLEX *can*

Natural hazards are no longer obstacles to the telephone engineer. Standard Time-sharing Multiplex can provide a thoroughly reliable trunk system which is easy to install and maintain in the most difficult terrain.

Each equipment deals with up to 24 channels, handling any kind of A.F. traffic in the 300-3400 c/s range, including teleprinter and automatic telephone signals. Time-sharing Multiplex ensures low crosstalk and noise levels, and fading does not affect speech levels.

A UHF carrier is used, and the normal line-of-sight range can be extended by automatic repeaters.

Complete terminal equipment occupies a double cabinet 7' wide x 2'4" deep x 6'6" high, and aeriels may be up to 100' from the main equipment.

Write for Bulletin No. 511 which gives further facts and figures.

Standard Telephones and Cables Limited Radio Division

OAKLEIGH ROAD, NEW SOUTHGATE, LONDON, N.11, ENGLAND
R.D.6.

Engineered to the Highest FM and AM Broadcast Standards



Model 650
(Output -46 db)

NEW!

High Fidelity Dynamic

BROADCAST
Microphones

FEATURES LIKE THESE
WIN TOP RATING

by Station and Network Engineers!

Flat out to 15 kcal! Extremely high output! Impedance selector! Dual-type shock-mount! Remarkably rugged! Individually calibrated!

Developed in cooperation with station and network engineers, the new "650" and "645" meet exacting requirements of modern high fidelity FM and AM broadcast service. Proved in studio and remote use. Polar pattern is non-directional at low frequencies, becoming directional at high frequencies. Recessed switch gives instant selection of 50 or 250 ohms impedance. Exclusive Acoustalloy diaphragm withstands toughest use. Many other important features assure the ultimate in broadcast quality. Satin chromium finish. Fully guaranteed.

Model 650. Output level -46 db. List \$150.00
Model 645. Output level -50 db. List \$100.00

Broadcast Engineers: Put the "650" or "645" to the test in your station. Know the thrill of using the newest and finest. Write for full details.

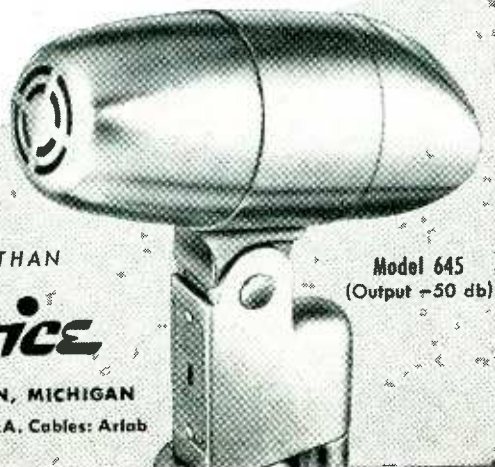

Model 645
(Output -50 db)

NO FINER CHOICE THAN

Electro-Voice

ELECTRO-VOICE, INC., BUCHANAN, MICHIGAN

Export: 13 East 40th St., New York 16, U.S.A. Cables: Arlab

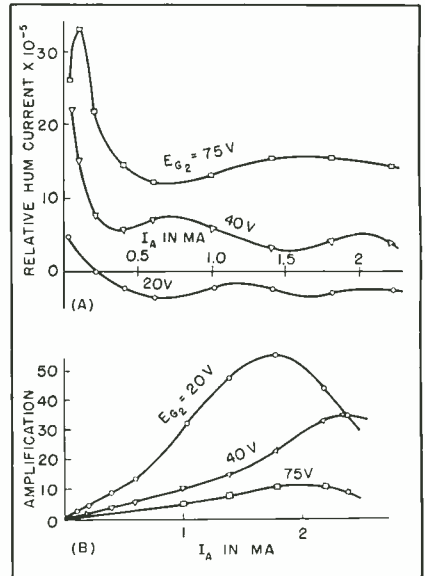

FIG. 4—Curves show change in hum and gain of variable-mu tube like a 58

4A one can infer that at some screen voltage between 20 and 40 volts there should be a hum curve having several zeros. From these measurements, as summarized in the introduction and as elaborated in these curves, it can be seen that the operating condition of a tube affects the relative hum current appearing in the plate circuit. Under special favorable conditions this hum current can be made to vary about zero magnitude.

In conclusion, I express my thanks to Mr. Nandor Szabo, chief of the Company Erdely and Szabo, for making the instruments, and to Mr. Henry Tabori for his help in the tests, which were completed in September 1944.

SURVEY OF NEW TECHNIQUES

STEREOSCOPIC SCREENS for motion picture or television projection before large audiences have been experimentally developed by E. G. Beard of the Philips Company in Sydney, Australia. In its simplest form the screen consists of a polished metal sheet engraved with over-lapping sets of concentric circular grooves of semicircular cross-section. The grooves act as concave mirrors that reflect the two images projected onto the screen to the observers at the correct angles. The

DO YOU CUT DISCS' OR DOLLARS'



Two years ago Soundcraft introduced the 'Broadcaster', a premium quality instantaneous recording disc. The "super" blank record costs more to make, is worth more to the broadcast engineer.

Representing but a small portion of the cost of a recorded program or record release, the blank disc is yet the heart of any recording project. No platter can be more expensive than one that loses a program or originates doubtful pressings. Soundcraft knew that key engineers appreciated these facts.

Soundcraft's judgment in offering the high-reliability 'Broadcasters' (master-selected discs in standard sizes) and the wax-like 'Maestros' (oversize discs for processing) has been vindicated by widespread acceptance on the part of makers of the best off-the-line recordings, transcriptions, and phonograph records.

For real economy don't cut your disc budget, cut the best disc!

Clip the coupon today for the story of how Soundcraft discs are made, the list of Soundcraft distributors, and your sample 'Broadcaster'.

*For real economy don't cut your disc budget,
cut the best disc!*

REEVES Soundcraft CORP.
10 EAST 52nd STREET • NEW YORK 22, N. Y.
Export Address
REEVINTER, N. Y.

To: REEVES SOUNDCRAFT CORP.
10 E. 52nd St., N. Y. 22, N. Y.
Please send story, distributor list, and free
sample 'Broadcaster' to

Name.....
Company.....
Address.....

The 'Broadcaster' The 'Playback' The 'Audition' The 'Maestro'

ALBANY: Fort Orange
Radio Distributing Co.
BALTIMORE: Radio Electric Service Co.
BOSTON: The Radio Shack Corp.
BUFFALO: Radio Equipment Corp.
CHICAGO: Walker-Jimieson Inc.
CINCINNATI: United Radio Inc.
CLEVELAND: Radio & Electronic
Parts Corp.
DETROIT: Radio Specialties Co.
HOUSTON: Geophysical Supply Co.
INDIANAPOLIS: Phillip E. Graham Co.
LOS ANGELES: Leo J. Meyberg Co.
MILWAUKEE: Radio Parts Co. Inc.
NASHVILLE: Electra Distributing Co.
NEWARK: Aaron Lippman & Co.
Parr Electric Co.
NEW ORLEANS: Radio Parts, Inc.
NEW YORK: E. B. Latham & Co.
NORFOLK: Radio Supply Co.
PHILADELPHIA: Rumsey Electric Co.
PITTSBURGH: Cameradio Co.
ST. LOUIS: Van Sickle Radio Co.
SAN FRANCISCO: Leo J. Meyberg Co.



ELECTRONS INCORPORATED
127 SUSSEX AVENUE
NEWARK, N. J.

In stock near you

RECTIFIERS

GRID CONTROL RECTIFIERS

principle can also be applied to transparent screens by using refracting circular elements instead of reflecting ones. Stereoscopic motion pictures have been successfully shown with the screen. Experiments will next be made to project stereoscopic television pictures in which the two views are transmitted with the interlacing, thus requiring no additional bandwidth.

NOISE has been put to good use by two physicists, Drs. J. V. Garrison and A. W. Dawson. By using the increase in thermal noise with temperature as an indication of temperature, they have devised a method of measurement that operates from absolute zero to about 5,000 F and is more accurate over this range than other means.

STATIC CHARGES can be dissipated as formed, thus preventing the possibility of abrupt discharges that produce interference, by placing minute amounts of polonium in the vicinity. Radiations from the rare radioactive element that are harmless to humans are, nevertheless, sufficient to ionize the surrounding air so that charges can be dissipated. Polonium can be plated easily onto other metals.

RESISTANCES from 10^6 to 10^{12} ohms, for use with phototubes, electrometers and other high-impedance devices, have been developed that consist of platinum evaporated on glass and sealed within a vacuum. Such resistors obey Ohm's law within about one percent from 0.1 to 300 volts, and are stable with time to within a few percent, unaffected by humidity, and are small, being about 2 inches long and 0.25 inch in diameter. A particularly interesting property of these resistors is that the magnitude of the noise produced by them equals that theoretically expected from the value of their resistance. Patented by D. Vodar, Laboratoire de Physique Enseignement, Sorbonne, Paris, the resistors are commercially produced by Etablissement Beaudouin (3 Rue Rataum, Paris).

Introducing— Two NEW Plasticon Developments

PLASTICON

TS CAPACITORS — are used in —

(operate from -80° to $+400^{\circ}\text{F}$)



The dielectric combination in Type TS capacitors consists of "Teflon" film and "Silicone" fluid. Both materials are unusually temperature-stable and have extremely low dielectric losses. Properly engineered and processed, Type TS capacitors have remarkable characteristics.

A typical example is Type TSG103-3. This is an .01 mfd. 3000VDC capacitor in a Glassmike style container 29/32" OD x 2 1/4" long. The DC resistance is in excess of 100,000 megohms at 150°C . The dissipation factor at one megacycle is .0005 at 70°C and .001 at 150°C . At 60 cycles, the dissipation factor is as low as .0002 — .0003.

The temperature coefficient of Type TS is negative, 300—400 parts per million per degree Centigrade.

We recommend Type TS capacitors for ultra high temperature DC applications and for RF bypassing and coupling duty.

PLASTICON PULSE FORMING NETWORKS

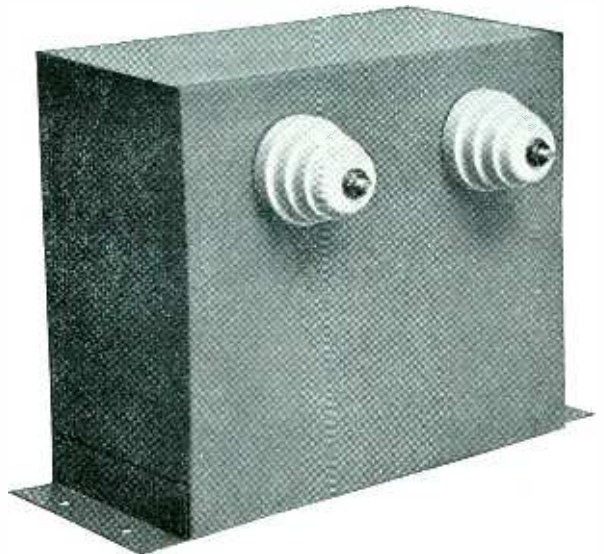

Type TS capacitors properly designed for pulse operation have many advantages over paper and mica capacitors. Type TS can operate at much higher ambient temperatures (150°C and up) but have much lower losses. The Type TS dielectric combination does not fatigue under pulse duty. PLASTICON networks are smaller and lighter.

Plasticon TS Pulse Forming Networks are designed to meet your specifications.



Condenser Products Company

1375 NORTH BRANCH STREET • CHICAGO 22, ILLINOIS



Fault Finder

We look for trouble in our coils—*before* they're built! Before a Wheeler coil is started, its component parts must be checked, tested, proved to be faultless.

The wire wound into Wheeler coils is no exception. It is closely inspected by experts—micrometer checks are made regularly to insure its uniformity. Only by following engineering practices proved over a long period of time can we be sure our coils will give the service and performance expected of them.

Wheeler coils—wound with Wheeler Magnet Wire—are rapidly becoming standard for the electrical industry. Investigate them today. They may be the answer to your electrical coil problems.

THE WHEELER INSULATED WIRE CO., INC.



DIVISION OF THE SPERRY CORPORATION

1011 WASHINGTON AVENUE
BRIDGEPORT 4, CONNECTICUT

MAGNET WIRE • COILS • COMMUNICATIONS EQUIPMENT

NEW PRODUCTS

(continued from p 130)

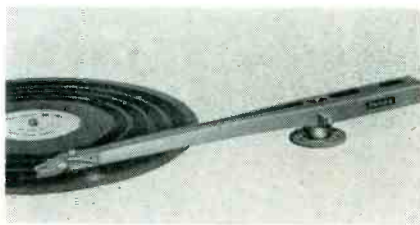

pressure of about 6 grams and cover a range from 40 cycles to over 10 kc.

Fidelity Pickup

SHURE BROTHERS, INC., 225 W. Huron St., Chicago 10, Ill. The 900MG crystal phonograph pickup for microgroove records provides high-fidelity reproduction. It tracks at 7 grams, has a needle force of



9 grams, uses an offset osmium-tipped needle with a 0.001-inch point radius and has an output of 1 volt.

High-Q Chokes

CHICAGO TRANSFORMER, 3501 W. Addison Blvd., Chicago, Ill. Designed specifically for use in dynamic noise suppressor circuits, the NSI-1 and NSI-2 reactors can be used in any tuned circuits requiring the given inductances. Induct-



To study the simultaneous characteristics of any device

**THIS
BIG...**

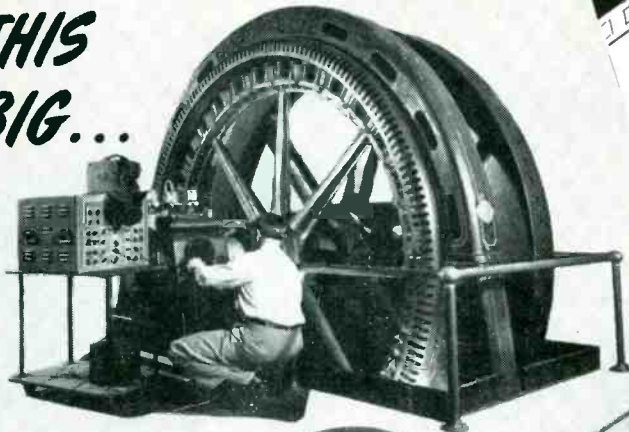

**or this
small...**



...use the
DU MONT Type 5 SP-
Dual-beam
**CATHODE-RAY
TUBE**

Both the concomitant electrical and/or mechanical characteristics of a piece of equipment may be conveniently examined and recorded with a Du Mont Type 5SP-Dual-beam Cathode-ray Tube. Especially so if used with a Du Mont Type 279 Dual-beam Cathode-ray Oscillograph.

For example: You can compare speed and vibration, velocity and acceleration. You can observe transient voltage and current; the input and output signals of amplifiers; related phenomena on different sweep frequencies; or again the complete signal and an expanded portion thereof. And for ease of recording, there is also available the Du Mont Type 314 Oscillograph-record Camera.

Indeed, the Type 5SP- is an unique cathode-ray tube since it embodies two complete and independent electron guns and deflection plate assemblies for the production of two entirely separate electron

beams. The Type 5SP- does not produce a split electron beam. Rather it presents two separate traces on the screen. Intensifier electrodes are used for high light output at maximum deflection sensitivities. Type 5SP- is also available with any of four different screen phosphors.

And please remember this: The Du Mont Type 5SP- is the only dual-gun cathode-ray tube registered with the Radio Manufacturers Association.

Details on request.

© ALLEN B. DU MONT LABORATORIES, INC.

DU MONT

for Oscillography

ALLEN B. DU MONT LABORATORIES, INC., PASSAIC, N. J.
CABLE ADDRESS: ALBEEDU, NEW YORK, N. Y., U. S. A.

100,000

QUESTION MARKS

... were put to work!

by the successful design and production of Elinco instrument-type fractional h.p. motors and generators that met special needs.



Yes, every finished Elinco motor or generator was born of a question mark. There was a job to be done . . . could Elinco engineer and produce a special unit to do the job? The answer is in the over 100,000 special Elinco units, successfully designed to the most exacting specifications, and now serving in practically every type and branch of industry. Special design is our business . . . not low-cost, mass-production motors . . . but special high-precision instruments demanding the highest engineering ability, and exceptional manufacturing skill and care.

there are over 400

Basic Models of Elinco Fractional H. P. Instrument-Type Motors and Generators

Units are produced to order, either by the design of a new model to meet your exact requirements, or by the adaptation of one of our over 300 basic units in order to meet your needs, either electrically or physically.

ELECTRIC INDICATOR CO.
PARKER AVENUE, STAMFORD, CONN.

NEW PRODUCTS

(continued)

ance values, 2.4 and 0.8 henrys respectively, are accurate within ± 5 percent with up to 15 ma d-c. Units have a minimum Q of 20.

Servo Tester

SERVO CORP. OF AMERICA, 2020 Jericho Turnpike, New Hyde Park, N. Y. The Servoscope is the first of

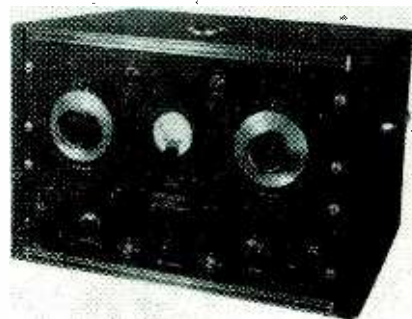

a line of design instrument aids for the servomechanisms engineer. It furnishes continuous performance data so that frequency response can be plotted and transient characteristics deduced in a few minutes. Rapid measurements are furnished of frequency-versus-amplitude attenuation and phase shift.

Audio-Frequency Meter

GENERAL RADIO Co., 275 Massachusetts Ave., Cambridge 39, Mass. Discontinued during the war years,

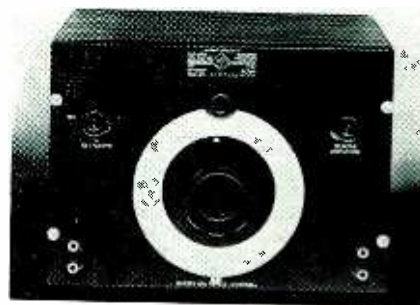

type 1141-A audio-frequency meter is again available. Using a null method, accuracy of the bridge is 0.5 percent. Because it uses a Wien bridge circuit, the instrument can be used as an adjustable-frequency filter over its range from 20 to 20,000 cycles.

Tripod Dolly

RADIO CORP. OF AMERICA, Camden, N. J. Type MI-26042 portable chrome-finished dolly may be used

THEY BOTH HAVE IT

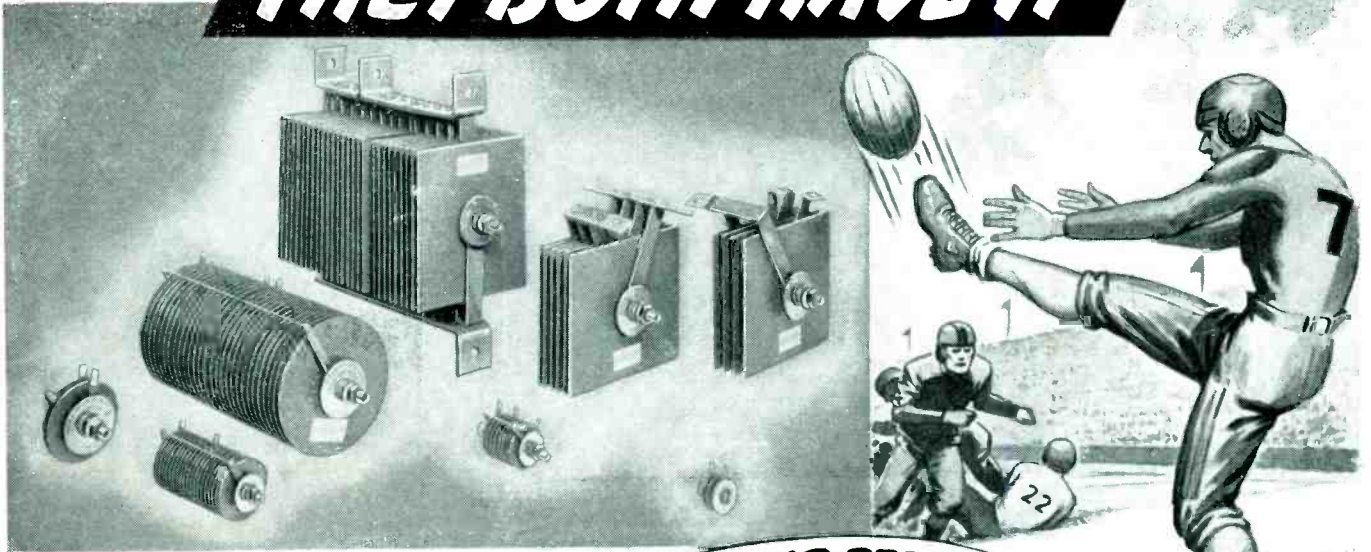

The EXTRA SOMETHING that spells TOP PERFORMANCE



Built on Aluminum

THE football star who eludes the players of the rival team and sends the pigskins hurtling down the field to a goal has "the extra something that spells top performance."

For outstanding service in every rectifier application specify Seleton Selenium Rectifiers. They have the "extra something" that spells top performance.

From the large power stacks to the miniature units for radio and television, Seleton uniformity and precision methods of manufacture, insures user satisfaction. Efficient—dependable, durable under the severest service conditions.

Furnished in a wide variety of voltages and currents to meet the individual requirements.

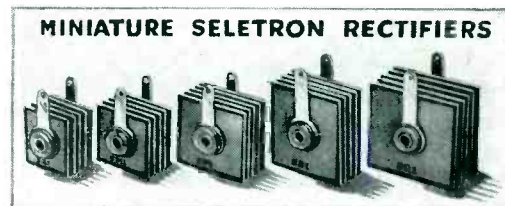

**SPECIFY SELETON
MINIATURE SELENIUM RECTIFIERS
FOR RADIO AND TELEVISION APPLICATIONS**

The complete family of miniature Seleton Rectifiers is designed for use on a nominal 115 A-C line, to provide direct current for radio, television sets, amplifiers, and other low power applications. Instant starting, small size, long life and simplicity of installation are a few of many features of the Seleton Family.

CODE NUMBER	5L1	5M1	5P1	5R1	5Q1
Current Rating	75 ma.	100 ma.	150 ma.	200 ma.	250 ma.
Plate Height	1"	1"	1 ³ / ₁₆ "	1 ¹ / ₂ "	1 ¹ / ₂ "
Plate Width	7/8"	1"	1 ³ / ₁₆ "	1 ¹ / ₄ "	1 ¹ / ₂ "

Write today for catalog. Address Dept. ES-11

SELETRON DIVISION
RR RADIO RECEPTOR COMPANY, Inc. RR
Since 1922 in Radio and Electronics
 251 WEST 19TH STREET, NEW YORK 11, N. Y.

Laboratory and Research Instruments

ENGINEERED FOR ENGINEERS

SWEEP CALIBRATOR Model GL-22

This versatile source of timing markers provides these requisites for accurate time and frequency measurements with an oscilloscope:



Positive and negative markers at 0.1, 0.5, 1.0, 10, and 100 microseconds • Marker amplitude variable to 50 volts • Gate having variable width and amplitude for blanking or timing • Trigger generator with positive and negative outputs. Further details in Bulletin MC-811

Enjoy High-fidelity RADIO RECEPTION WITH THE Browning FM or FM-AM Tuner

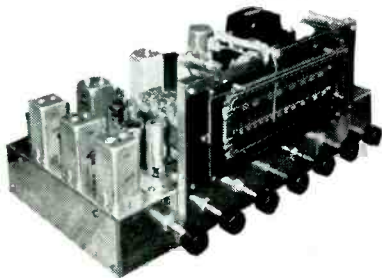

This is the new Model RJ-20 FM-AM Tuner . . . designed for high-fidelity reception on both FM and AM, and built to meet your highest performance requirements. Its features include:

- Armstrong FM circuit for maximum noise reduction and full frequency response to 15,000 cycles.
- Separate RF and IF systems for FM and AM . . . no coil switching.
- Variable bandwidth IF gives AM bandwidths from 9 kc. to 4 kc.
- Two-stage audio system allows 20 db. boost in bass or treble range.
- New 6AL7 tuning eye for precise tuning on strong or weak FM stations.
- Self-contained power supply.

See, hear, and handle this new Browning Tuner . . . and enjoy new satisfaction in your radio and music reproduction.

Write today for Data Sheet MT-811

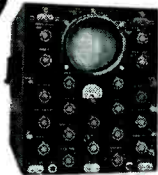

OSCILLOSYNCHROSCOPE Model OL-15B

Provides a variety of time bases, triggers, phasing and delay circuits, and extended-range amplifiers in combination with all standard oscilloscope functions.

Extended-range amplifiers: vertical, flat within 3 db 5 cycles to 6 megacycles; horizontal, flat within 1 db 5 cycles to 1 megacycle • High sensitivity: vertical, 0.05 RMS volts per inch; horizontal 0.1 RMS volts per inch • Single-sweep-triggered time base permits observation of transients or irregularly recurring phenomena • Variable delay circuit usable with external or internal trigger or separate from scope • Sawtooth sweep range covers 5 cycles to 500 kilocycles per second • 4,000-volt acceleration gives superior intensity and definition. Request Bulletin MO-811

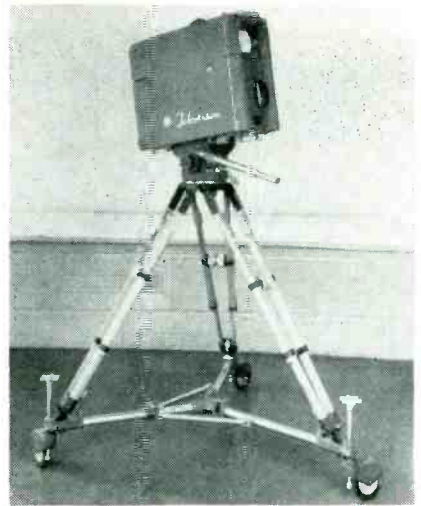

HERE'S PERFORMANCE to satisfy the man who knows radio . . . provable by both instrument and listening tests.

CHECK THESE CURVES and you'll see why Browning Tuners are chosen by those who insist upon the best.

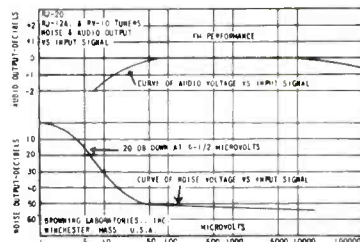
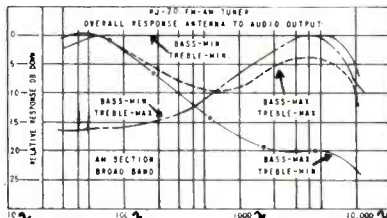
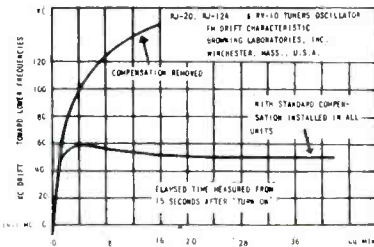

To feed a separate high-fidelity audio system, use the Browning RJ-12A for FM/AM or the Browning RV-10 for straight FM. They're all "tops" in the high-fidelity field.



BROWNING
LABORATORIES, INC.
WINCHESTER, MASS.

ENGINEERED FOR ENGINEERS

NEW PRODUCTS

(continued)

both for field-type and studio television tripods. It can be locked in a fixed position by means of spring-loaded stop-feet.

Cabinet Racks

ECLIPSE MFG. Co. INC., 294 East 137th St., New York 54, N. Y. A new line of six cabinet racks is available with panel heights rang-

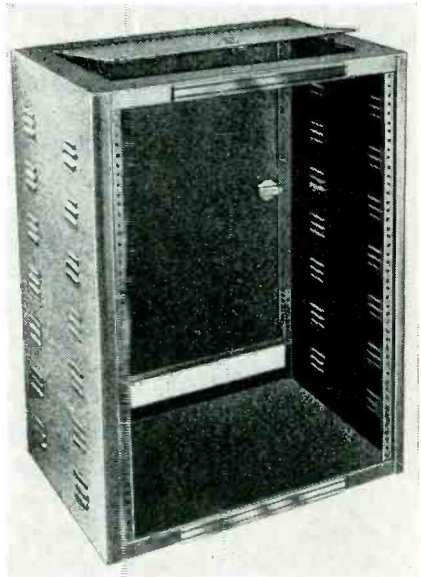

ing from 8 3/4 to 35 inches. Mounting holes are tapped for 10-32 screws with standard or amateur hole spacing.

Mobile Equipment

COMMUNICATIONS Co., INC., 300 Greco Ave., Coral Gables, Florida. Model 275-C radiotelephone equipment is designed for mobile applications in the emergency services operating in the 152 to 162-mc f-m

One of a series of messages to help you increase your understanding of business paper advertising, and its effect on your job.

You know more about advertising than you think !

IF YOU UNDERSTAND the basic principles of mass production —

If you're on familiar ground when it comes to time-motion studies, obsolescence curves, and assembly-line techniques —

If you regard every operation in your plant as a challenge to further reduce your manufacturing cost-per-unit —

Then you know a lot more about advertising than you think. Yes, *advertising!*

For basically, advertising is the application of assembly-line techniques

to the *manufacture of a sale*. And how are sales manufactured? Like any other commodity, by sequence of "processing operations." In this case they include —

1. Seeking out prospects
2. Arousing their interest
3. Creating a preference for your product
4. Making a specific proposal
5. Closing the order

Couldn't your salesmen handle this entire sequence? Certainly — if you had *enough* salesmen, and weren't concerned about the cost. But no

salesman should *have* to spend his valuable time on missionary work. Not when those first three steps can be *mechanized* for him — not when they can be handled so much more economically — through the efficient use of business paper advertising.

Why *business papers*? Because nowhere does your advertising work more efficiently than in the business publications which reach your best prospects. Nowhere else can "mechanized selling" contribute so much toward reducing the cost of manufacturing a sale!



ELECTRONICS

is a member of The Associated Business Papers, who have published an interesting folder entitled, "10 ways to measure advertising effectiveness." We'll be glad to send you a copy. And if you'd like reprints of this advertisement (or the entire series) to pass along to others in your organization, just say the word.

CURRENT CONVERSION

ATR

STANDARD AND HEAVY DUTY INVERTERS



For Inverting D. C. to A. C. . . .

Specially Designed for operating A. C. Radios, Television Sets, Amplifiers, Address Systems, and Radio Test Equipment from D. C. Voltages in Vehicles, Ships, Trains, Planes and in D. C. Districts.

NEW PRODUCTS

(continued)

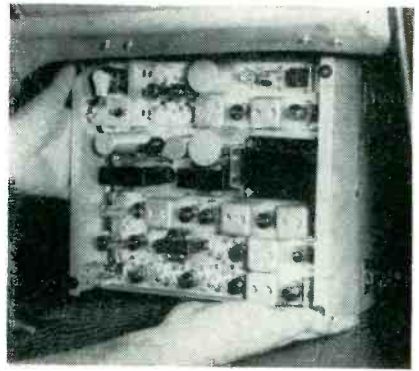

band and is also available for other f-m services operating above 30 mc. The unit weighs 20 pounds, has a transmitter power output of 8 to 10 watts, a battery drain of 6 amperes standby, and 13 amperes when transmitting. Audio output from receiver is over 1 watt.

Deflection Cores

HENRY L. CROWLEY & Co., INC., 1 Central Ave., West Orange, N. J. A two-piece frame and center slug

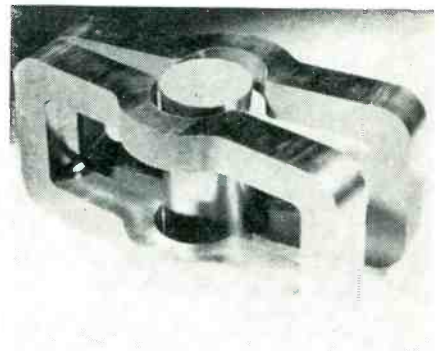

assembly of powdered iron is being made for television receiver deflection transformers. Effective a-c permeabilities in the order of 40 to 230 are attainable. Hum noise is low as compared with that produced in laminated core structures.

Bridge Amplifier

RUGE-DE FOREST, 76 Massachusetts Ave., Cambridge, Mass. The new deflection-type amplifier is designed for use with resistance



ATR
AUTO RADIO VIBRATORS
A Complete Line of Vibrators . . .
Designed for Use in Standard Vibrator-Operated Auto Radio Receivers. Built with Precision Construction, featuring Ceramic Stack Spacers for Longer Lasting Life.

New Models

ATR VIBRATOR GUIDE
a complete line

New 36 page VIBRATOR GUIDE FREE

ATR
"A" BATTERY ELIMINATORS
For DEMONSTRATING AND TESTING AUTO RADIOS

New Models . . . Designed for Testing D. C. Electrical Apparatus on Regular A. C. Lines. Equipped with Full-Wave Dry Disc Type Rectifier, Assuring Noiseless, Interference-Free Operation and Extreme Long Life and Reliability.

NEW MODELS
NEW DESIGNS
NEW LITERATURE
See your jobber or write factory

AMERICAN TELEVISION & RADIO Co.
Quality Products Since 1931
SAINT PAUL 1, MINNESOTA-U. S. A.

Helipot

Trademark of the **HELICAL POTentiometer!**

THE REVOLUTIONARY Potentiometer that Gives You 46½" of Slide Wire in a Panel Space 1½" in Diameter!

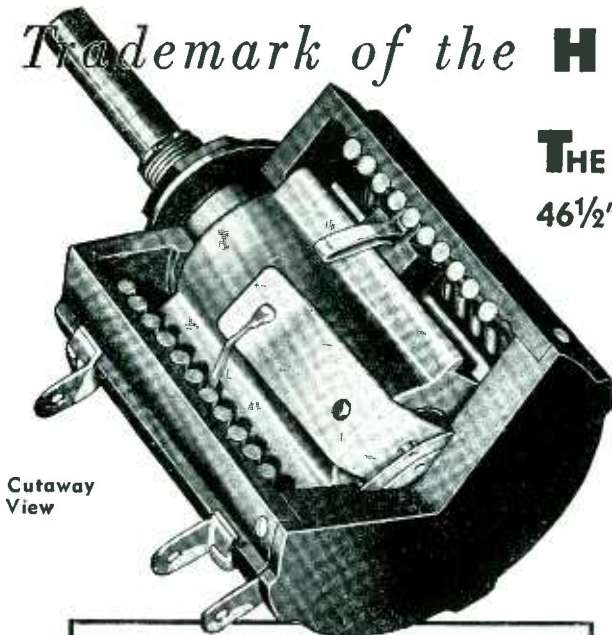

Cutaway View

A SIZE FOR EVERY APPLICATION!

Helipots are available in a wide range of sizes and types to meet varying application requirements. Standard Helipots include the following . . .

Model A—Case diameter—1.8" Number of turns—10; Slide wire length—46½"; Rotation—3600°; Power rating—5 watts; Resistance ratings—10 to 100,000 ohms.

Model B—Case diameter—3.3"; Number of turns—15; Slide wire length—140½"; Rotation—5400°; Power rating—10 watts; Resistance ratings—50 to 300,000 ohms.

Model C—Case diameter—1.8" Number of turns—3; Slide wire length—13½"; Rotation—1080°; Power rating—3 watts; Resistance ratings—5 to 30,000 ohms.

In addition, special models of Helipots in production include . . .

Model D—Case diameter—3.3"; Number of turns—25; Slide wire length—234"; Rotation—9000°; Power rating—15 watts; Resistance ratings—100 to 500,000 ohms.

Model E—Case diameter—3.3"; Number of turns—40; Slide wire length—373"; Rotation—14,400°; Power rating—20 watts; Resistance ratings—150 to 800,000 ohms.

Throughout the electronic industry—wherever quality electronic instruments are designed, manufactured or used—the big news is HELIPOT, the helical potentiometer-rheostat that is making possible entirely new standards of accuracy, convenience and compactness in modern electronic equipment. Briefly, here's what makes the *Helipot* so unique . . .

*Instead of a single partial turn of slide wire as found in the conventional potentiometer, the Helipot has many full turns of slide wire coiled into a compact helix requiring no more panel space than the ordinary potentiometer. The sliding contact follows the long helical path of the slide wires from end to end when a single knob is rotated. Thus, the Helipot requires the same panel space—the same single control knob—as a conventional potentiometer . . . yet it provides the wide range control and accuracy of a slide wire approximately twelve times as long.**

In other words, whereas the conventional rheostat gives approximately 300° of rotation, the 10-turn Helipot gives 3600° of rotation in the same panel space. Think what this important advancement can mean in simplifying the control, increasing the convenience and improving the accuracy of your electronic equipment. Helipots are already being used in a wide range of devices—depth sounding equipment, flight control instruments, electrical computers, strain-gage circuits, oscilloscopes and other indicating and measuring apparatus, and a great variety of other electronic applications. Let our engineering staff study your control problem and show you how Helipots can increase the accuracy, utility and simplicity of your equipment. There's no obligation, of course.

* For the standard 10 turn, 1½" unit. Other sizes proportional. We are also equipped to supply other types of potentiometer-rheostats. Send us your requirements.

Write for data on the
DUODIAL

the ideal turns-indicating dial for use with the Helipot. Compact, simple and fool-proof, here's a dial that requires no more panel space than conventional dials. Yet it contains TWO concentric dials—a PRIMARY dial that indicates rotational position of the slider . . . and a SECONDARY dial that shows number of complete revolutions of the Primary dial. Available in a wide range of turns-ratios for all sizes of Helipots—and for other helical applications.



Send for descriptive details!

Send for Helipot booklet!



THE **Helipot** CORPORATION, SOUTH PASADENA 2, CALIFORNIA



THE LOW-LOSS, HIGH FREQUENCY INSULATION for every electrical and mechanical requirement

MYCALEX, a most versatile, low-loss insulation material, possesses unusual characteristics that ideally suit it for use in ultra high-frequency applications. It can be molded, or machined to very close tolerances—it is impervious to water, oil or humidity; has dimen-

sional stability, high dielectric strength and will not carbonize. Metal inserts can be molded into the material giving it an almost endless number of applications in the field of electronics. It is available in the three following types:

MYCALEX 410

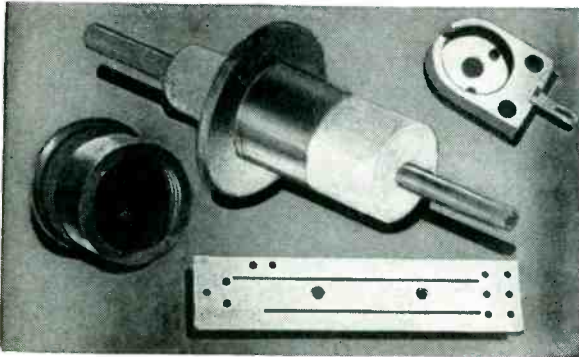

This injection-molded form of Mycalex is useful in 4 cases:
1. When shape is too intricate to permit fabrication by machine.
2. When quantities necessitate high production and low cost.
3. When great dimensional stability is essential. (Mycalex 410 can be molded to very close tolerances.)
4. When metal inserts must be incorporated into the insulator. These inserts may be made of any common metal that can withstand temperatures of about 1200° F and that has a coefficient of thermal expansion of the order of 100 to 175×10^{-7} per degree C. Mycalex metal seals can withstand pressure of 90 psi.

MYCALEX 400

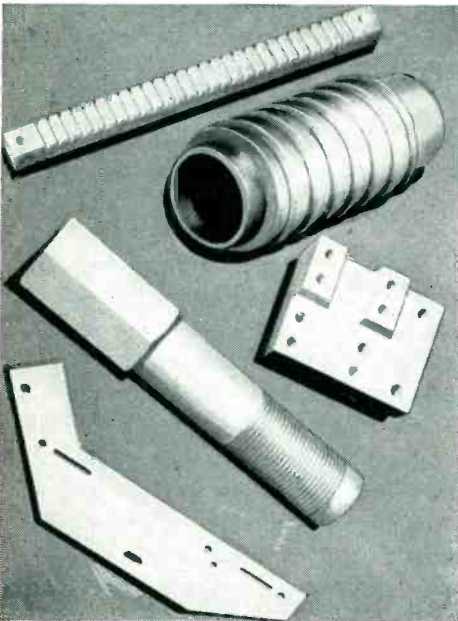

Compression molded for high-frequency applications. Its loss factor is well within requirements for operation in this portion of the electromagnetic spectrum. An outstanding characteristic is the long frequency range over which the loss factor is a minimum. Tropical climates do not impair its electrical and physical properties. It is, therefore, used for insulation in radio transmitters, radio receivers, communication panels, switchboard panels, arc shields in high tension switches, brush holders, relay contact supports, etc. Available in sheets 14 by 18 in.; thickness of $\frac{1}{8}$ to 1 in. Rods 18 in. long, diameter $\frac{1}{4}$ to 1 in.

MYCALEX K series

Ceramic Capacitor Dielectrics. Many ceramic materials offer low power factor, negligible moisture absorption, high dielectric strength, lack of cold flow, ability to withstand high temperatures. Few, however, include a dielectric constant greater than 7 or 8 at radio frequencies. Few are available with flat surfaces of large dimensions that don't warp, or close tolerances in rods. Mycalex K capacitor dielectrics combine all of them and is available in practically any form. Power factor varies from 0.002 to 0.004 at 1 mc.

MYCALEX FABRICATING SERVICE

Mycalex can be machined to customers' exact specifications in our new plant at Clifton, N. J. This plant is especially tooled for large volume machining of Mycalex in a wide variety of forms. This service offers the following advantages . . . **PRECISION WORKMANSHIP:** specialized equipment that assures remarkable precision and super-

vision by skilled engineers. **REDUCED COSTS:** substantial savings effected by efficient performance on a quantity basis. **RELIEF TO PLANT BOTTLENECKS. PROMPT DELIVERIES.** Consult our engineering staff for advice on the application of Mycalex to your insulating problems.

MYCALEX CORPORATION OF AMERICA

"Owners of 'MYCALEX' Patents"

Plant and General Offices CLIFTON, N. J.

Executive Offices, 30 ROCKEFELLER PLAZA, NEW YORK 20, N. Y.

bridges ranging in impedance from 100 to 500 ohms and having a full-scale output as small as 25 microvolts per volt of input to the bridge, or as large as 5 millivolts per volt. Output is 18 volts across an external 1500-ohm load with a linearity of 0.5 percent. Frequency response is flat to ± 2 percent from 0 to 50 cycles when working into a resistive load.

Electrical Insulation

JOHNS-MANVILLE, 22 E 40th St., New York 16, N. Y. An asbestos-base, completely inorganic electrical

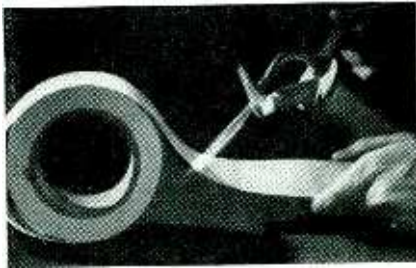

insulation, Quinterra was designed for use where high temperatures are encountered since it retains its dielectric strength of over 250 volts per mil. It has already been used as wire insulation in transformers.

Equalizer

BROCINER ELECTRONICS LABORATORY, 1546 Second Ave., New York 28, N. Y. Model A65 amplifier and



companion model P6-300 d-c power supply provide a means of compensating magnetic phonograph pickups to various recording characteristics. Turnover frequencies of 300, 500, and 800 cycles are accommodated.

F-M Transceiver

DOOLITTLE RADIO, INC., 7421 South Loomis Blvd., Chicago 36, Ill. The PJZ-1 portable f-m transmitter and receiver with quarterwave telescopic antenna is designed for operation on a single frequency in the

An Important Statement by **MYCALEX** **CORPORATION OF AMERICA**

An explanation of the properties and advantages of Mycalex (glass bonded mica) 410, Mycalex 400, and Mycalex K are given on the opposite page.

Your attention is also called to the Mycalex 410 advertisement which appeared on pages 54 and 55 of the October 1948 issue of Electronics.

Constant research, improved technics, advances in the art, new, modern plant expansion, improved engineering, more efficient manufacturing equipment—now permit us to make available in increased quantities—Mycalex 410—molded—at prices comparable to other less efficient molded insulations.

MYCALEX 410 is now priced to meet rigid economy requirements

Any interest evidenced on your part in Mycalex products and services—will receive the prompt, courteous and intelligent attention of a competent Mycalex sales engineer. He will receive the fullest backing and cooperation from other factory executives—to serve you promptly—with a quality product and at an economical and fair price.



Simplify WITH S.S. WHITE FLEXIBLE SHAFTS

Make controlled parts
more **ADAPTABLE**
to your designs

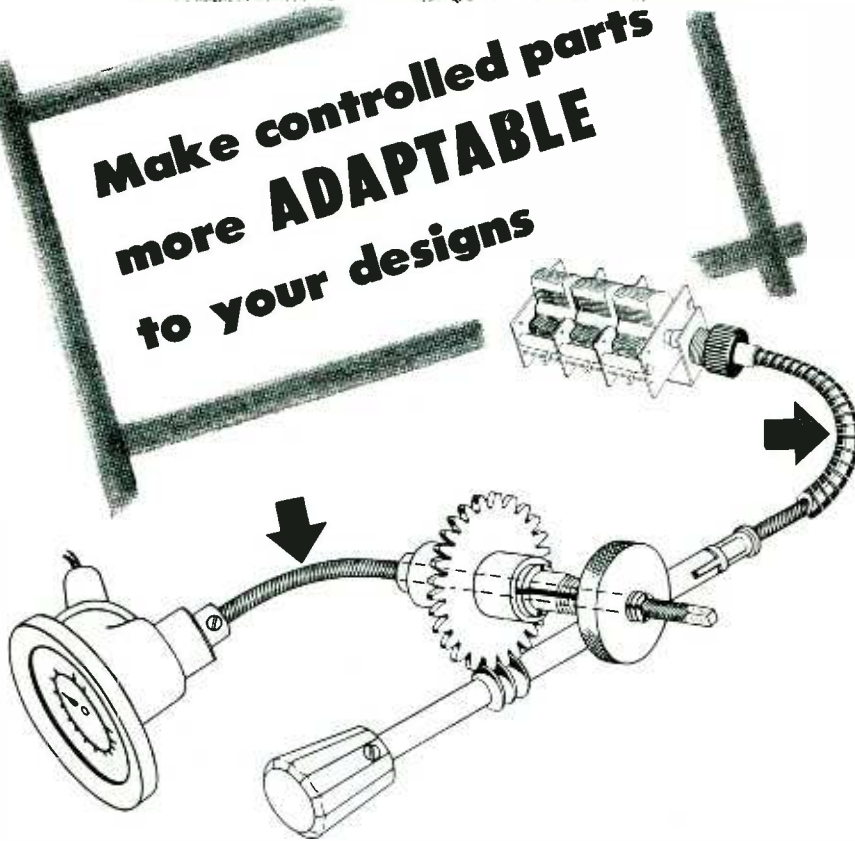

Adaptability is a prime advantage you gain by using S.S. White flexible shafts to couple variable elements to their control knobs or dials.

The example above shows why. The flexible shaft coupling permits you to position both the condenser and its control knob independently of each other. Likewise, the flexible shaft that transmits the movement of the tuning control shaft through a worm gear to the indicating dial makes it possible to place the dial where desired.

This adaptability of parts provided by S.S. White flexible shafts greatly simplifies the problem of satisfying such design requirements as circuit efficiency, easy assembly, wiring and servicing.

S.S. White remote control flexible shafts come in a wide range of sizes and characteristics and can be supplied in any required length. Specially designed for remote control they are positive, sensitive and jump-free in operation.

GET DETAILS IN THIS FLEXIBLE SHAFT HANDBOOK

You can get a free copy of this informative 260-page book on flexible shaft application and selection by writing to us on your business letterhead and mentioning your position.



S.S. WHITE

THE S. S. WHITE DENTAL MFG. CO. DIVISION



DEPT. E 10 EAST 40TH ST., NEW YORK 16, N. Y.
FLEXIBLE SHAFTS • FLEXIBLE SHAFT TOOLS • AIRCRAFT ACCESSORIES
SMALL CUTTING AND GRINDING TOOLS • SPECIAL FORMULA RUBBERS
MOLDED RESISTORS • PLASTIC SPECIALTIES • CONTRACT PLASTICS MOLDING

One of America's AAAA Industrial Enterprises



30 to 44-mc band. Power output of the transmitter is $\frac{1}{2}$ watt, obtained from two 2-volt storage batteries. The receiver has a $1\frac{1}{2}$ - μ v sensitivity for 20-db silencing, and selectivity is 85 db down at 100 kc and 40 db down at 40 kc.

Colorimeter

BROCINER-MASS INSTRUMENTS, INC.,
1546 Second Ave., New York 28,
N. Y. The Clinical Analyzer is a

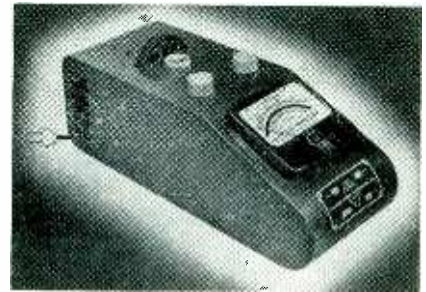

photoelectric colorimeter calibrated for 60 clinical determinations. The instrument uses test tubes 17 and 11 mm in diameter. Five filters in a revolving disc permit quick selection.

Klystron Oscillators

RADIO CORP. OF AMERICA, Harrison, N. J., announces the 2K26 (illustrated) and 2K56 klystron oscillators of the single-resonator, reflex type intended primarily for use as local oscillators in microwave receivers. The 2K26 is designed for operation in the 6,250 to 7,060-mc



NOW Magnavox produces over 100 different speaker models exclusively for the manufacturing trade. From start to finish they are researched, designed and produced by engineers whose sole business is the making of better loud speakers... whose complete plant facilities are constructed specially for the quickest, most efficient manufacture of quality loud speakers!

The modern 2½-acre Magnavox Paducah factory is a model of engineering achievement. Everything from the building itself to the equipment and

method of line assembly used is new and different. And the innovations measure up! World-famous Magnavox speakers now are coming off the line at a greatly accelerated pace.

All the skill and experience Magnavox has amassed in thirty-three years of service to the radio industry combine with a complete line of quality speakers to make this modern new plant loud speaker headquarters! Write for catalog today.

The Magnavox Company, Sales and Engineering Offices, Components Division, Ft. Wayne 4, Indiana.

Magnavox is the oldest and largest producer of quality loud speakers

Magnavox

has served the radio industry for over 33 years

SPEAKERS • CAPACITORS • SOLENOIDS • ELECTRONIC EQUIPMENT

ELECTRONICS — November, 1948

TRIPLE INDEMNITY WITH

ALPHA TRI-CORE *Rosin-filled* SOLDER

faster • more economical • more efficient

Alpha Tri-Core rosin-filled solder—with 3 cores instead of 1—gives you three times the "performance insurance" you get from ordinary solder. The simple facts are: You get more for your money with Alpha Tri-Core rosin-filled solder—more speed! More operations per pound! More operations per hour! In addition, Tri-Core permits the use of lower-tin-content alloys with superior soldering results to that obtained from ordinary solders with 5-15% more tin. Can you—can any manufacturer—afford to overlook such outright savings these days? Write for samples or trial order and put Alpha through your own tests in your own shop. It is the accepted solder by over 70% of electronic equipment manufacturers.

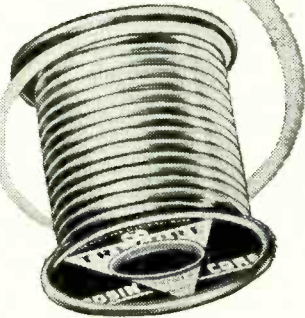

MORE FOR YOUR MONEY WITH ALPHA TRI-CORE ROSIN-FILLED SOLDER



- 3 cores of flux instead of 1—at no extra cost!
- Even distribution of flux throughout . . . no fluxless areas!
- 22% more joints per pound of solder!
- 25% more joints per hour of soldering time!
- No high-resistance joints! No inspection rejects! No returns!
- 99.9% pure, water-white rosin used exclusively!
- No toxic fumes! Preferred by solderers everywhere!
- Absolutely non-corrosive; non-hydroscopic flux residue is glass-like in hardness and non-conductive!

Alpha

other ALPHA PRODUCTS include:
 TRI-CORE "ENERGIZED" ROSIN-FILLED SOLDER;
 TRI-CORE "LEAK-PRUF" ACID-FILLED SOLDER;
 SOLID SOLDER WIRE; PREFORMS (rosin and acid-filled); BAR SOLDER, ANODES AND FOIL.

ALPHA METALS, INC., 371 HUDSON AVENUE, BROOKLYN 1, NEW YORK

NEW PRODUCTS

(continued)



range, and the 2K56 in the range from 3,840 to 4,460 mc. Both have a useful power output in the order of 100 milliwatts.

Remote Amplifier

RADIO CORP. OF AMERICA, Camden, N. J., has announced a lightweight, portable remote amplifier designed



to provide high-fidelity audio pick-up for a-m and f-m broadcasts. The 3-channel amplifier, type BN-2A, has built-in power supply for use with standard 115-volt, 60-cycle outlets, but may also be battery-operated. Each channel offers an overall gain of 92.5 db.

Electrolytic Capacitors

CORNELL-DUBILIER ELECTRIC CORP., South Plainfield, N. J. Type KP

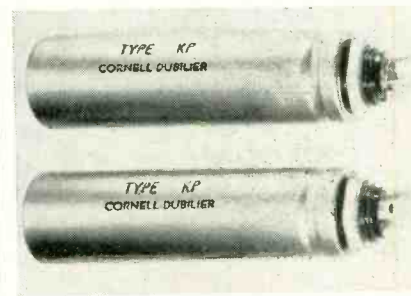

A New Type of Bridge Makes Balanced Measurements at V. H. F.

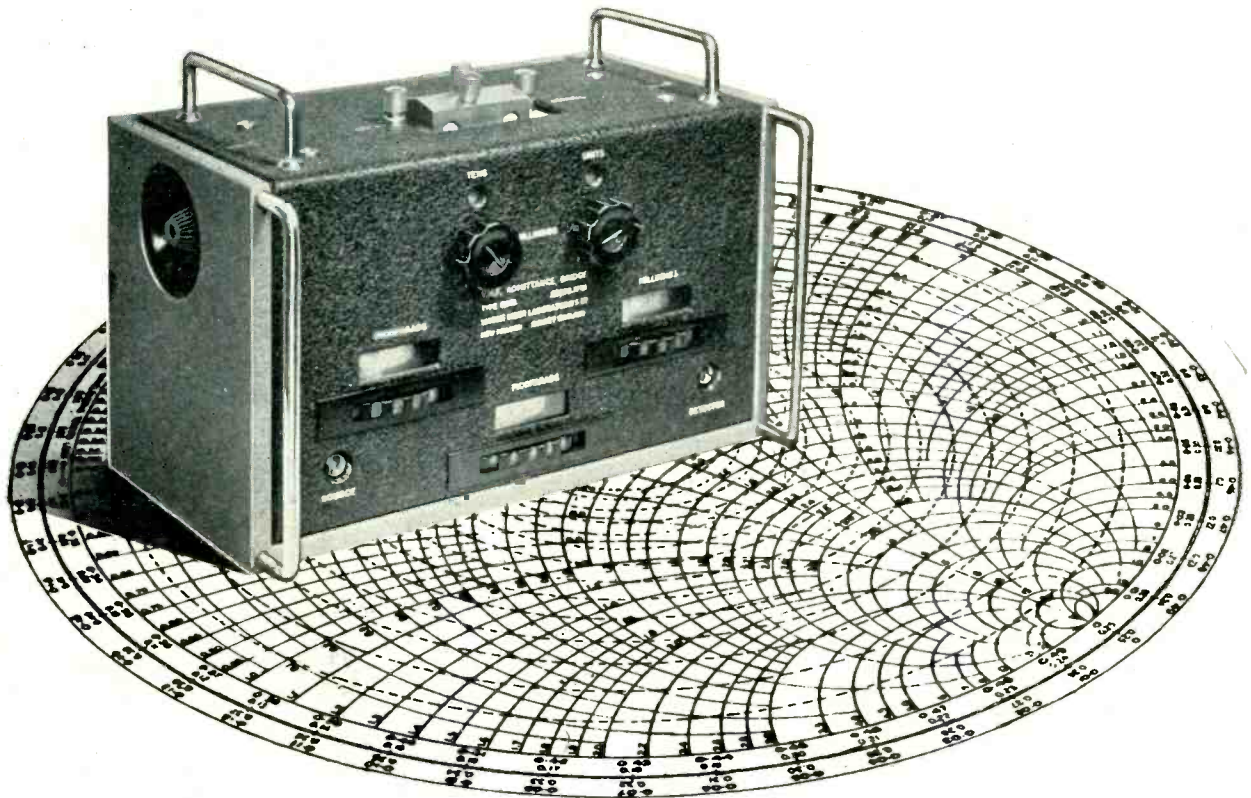

THE use of tape-wound transformers on toroidal cores has made possible the development of a new type of high frequency bridge. The technique was originated in the Research Dept. of the B.B.C., who found it necessary to provide a more rapid and accurate means of measuring antennae, feeders and cables. Subsequent development by Wayne Kerr has considerably extended the field of application by

increasing the useful frequency range to above 100 Mc/s. The same principle is employed in a multi-ratio instrument having a wide range of application and high accuracy. The two bridges described are now in production and both offer the advantage that balanced and unbalanced measurements can be made with equal facility.

V.H.F. BRIDGE Type B801 (Above)
1 Mc/s. to 100 Mc/s.
Ranges—Conductance: 0—100 m/mhos.
Susceptance: Corresponding to +250 pfd.
General accuracy: 2%.

R.F. BRIDGE Type B601 (Right)
15 Kc/s.—5 Mc/s. Capacity: 0.1 pfd.—20,000 pfd.
Resistance: 10 ohms.—10 megohms. Inductance: Values resonating above capacities between 15 Kc/s. and 5 Mc/s.
General accuracy: 1% to 3 Mc/s.—2% to 5 Mc/s.



Wayne

Kerr

THE WAYNE KERR LABORATORIES LIMITED, NEW MALDEN, SURREY, ENGLAND

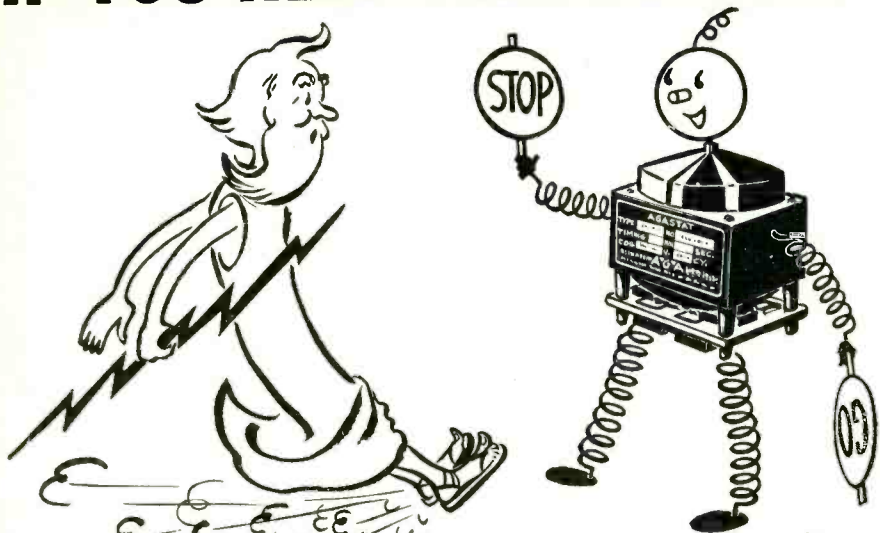
IF YOU NEED TIME DELAY...



YOU NEED AGASTAT

Made in two types for direct current operation, and two corresponding types for alternating current operation:—

1. Time delay starts when coil is energized.
2. Time delay starts when coil is de-energized.

Time delay from .1 second to 5 or more minutes. Complete data from

A G A

AMERICAN GAS ACCUMULATOR COMPANY
1029 Newark Avenue • Elizabeth 3, New Jersey

AMPERITE

**Studio Microphones
at P.A. Prices**

Ideal for BROADCASTING
• RECORDING
• PUBLIC ADDRESS

"The ultimate in microphone quality," says Evan Rushing, sound engineer of the Hotel New Yorker.

- Shout right into the new Amperite Microphone—or stand 2 feet away—reproduction is always perfect.
- The only type microphone that is not affected by any climatic conditions.
- Guaranteed to withstand more "knocking around" than any other type mike.

Special Offer: Write for Special Introductory Offer, and 4-page illustrated folder.



Models
RBLG—200 ohms
RBHG—Hi-imp.
List \$42.00



"Kontak" Mikes
Model SKH, list \$12.00
Model KKH, list \$18.00

AMPERITE Company, Inc.

561 BROADWAY • NEW YORK 12, N. Y.

In Canada: Atlas Radio Corp., Ltd., 560 King St. W., Toronto



For extraordinary
electrical performance

**Use SILVER
GRAPHALLOY***



THE SUPREME CONTACT MATERIAL



BRUSHES

CONTACTS

in BRUSHES
for high current density • minimum wear • low contact drop
low electrical noise • self-lubrication

in CONTACTS
for low resistance • non-welding character

GRAPHALLOY works where others won't
Specify GRAPHALLOY with confidence.

*A special silver-impregnated graphite

**GRAPHITE METALLIZING
CORPORATION**

1055 NEPPERHAN AVENUE, YONKERS 3, NEW YORK

electrolytic capacitors designed for electronic and communications equipment are available in two and three-lug terminal assemblies. Two-lug units can be had from 15 microfarads at 100 working volts to 80 microfarads at 450 working volts; three-lug terminals are suitable for either dual or triple capacitance units. Write for bulletin 123.

T-F Analyzer

FAIRCHILD CAMERA AND INSTRUMENT CORP., 88-06 Van Wyck Blvd., Jamaica 1, N. Y. The transfer func-



tion analyzer has been designed for measuring the performance characteristics of servo systems. By means of the equipment, amplitude and phase of servos using signal frequencies between 50 and 800 cycles can be checked. It can also be modified for use with d-c systems.

Laboratory Power Supply

W. GREEN ELECTRIC CO., INC., 130 Cedar St., New York 6, N. Y. The MR1 Multi-Rectifier power supply was produced to meet the need for a high-amperage laboratory unit. It



PIONEERS in TIMING

and MARINE RADAR

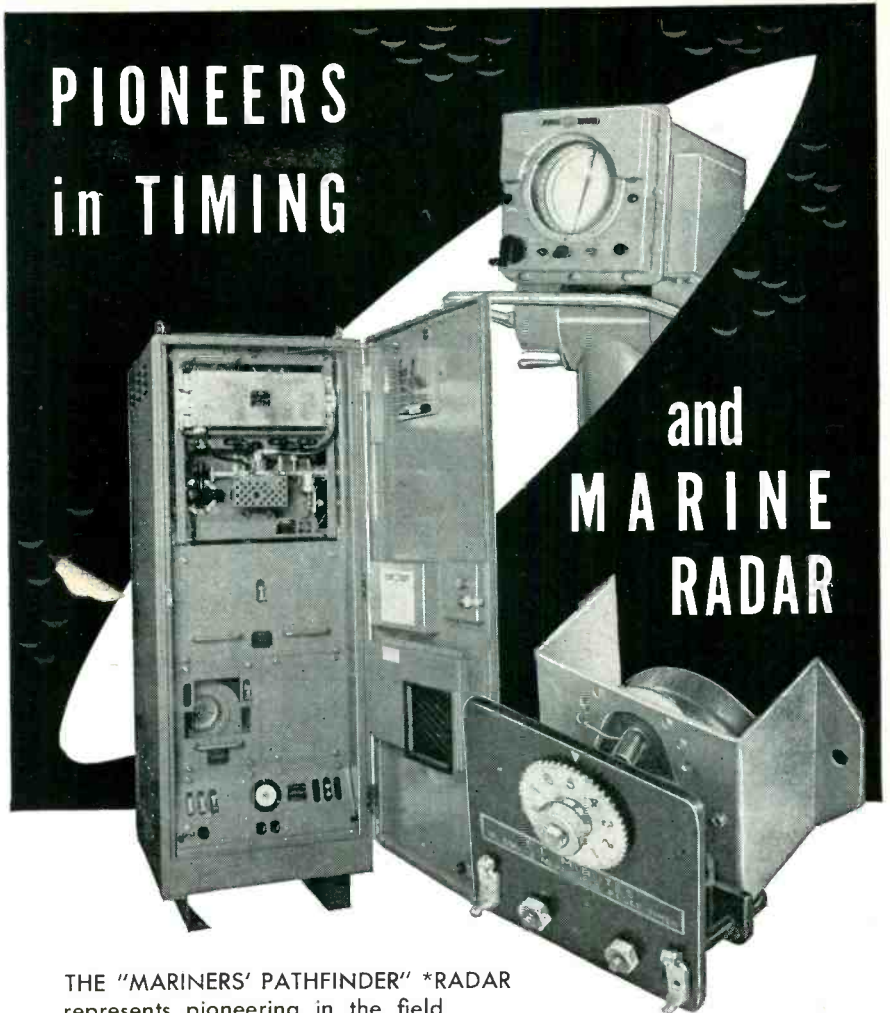

THE "MARINERS' PATHFINDER" *RADAR

represents pioneering in the field of navigation by the Raytheon Manufacturing Co. and in the field of timing by Haydon Manufacturing. The development of equipment components enabling today's ships to sail safely and on schedule in all weather is typical of Haydon's pioneering in the science of timing. Knowing that any equipment is only as good as its components, Raytheon relies on the quality of Haydon timers for dependable radar operation. In one model, a 5901 series time delay relay protects a magnetron tube by providing a 3 minute interval for tube warm-up prior to application of plate voltage. In another a Haydon timer provides a 5 second delay to allow a motor generator to attain operating speed. A third delays operation of rectifier tubes 45 seconds. In each instance engineering by Haydon and Raytheon is coupled to insure dependable operation.

For thoroughly reliable timing devices, take time to talk time with Haydon. See the Haydon insert in Sweet's File for Product Designers, or write for your own copy of the complete Engineering Catalog. An experienced field representative will be pleased to discuss your requirements and demonstrate Haydon timing at your desk.

* "Mariners' Pathfinder" is the trademark of Raytheon Manufacturing Co., denoting its commercial search radar.

WRITE 2411 ELM STREET, TORRINGTON, CONNECTICUT

HAYDON

MANUFACTURING COMPANY, INC.

TORRINGTON

CONNECTICUT

HARNESS TIME TO



YOUR PRODUCTS

SUBSIDIARY OF GENERAL TIME INSTRUMENTS CORPORATION

Only AIR EXPRESS gives you all these advantages

A combination you don't get
with other air-shipping methods

- 1.** Special pick-up and delivery *at no extra cost*. Your shipments are picked up promptly when you call; fast delivery to consignee's door.
- 2.** You get a receipt for every shipment, and delivery is proved by signature of consignee. One-carrier responsibility. Complete security.
- 3.** Assured protection, too—valuation coverage up to \$50 without extra charge; 10 cents for each additional \$100 or fraction thereof.

These advantages, plus 21 others, make Air Express the best and fastest way to ship. Your shipments go on every flight of the Scheduled Airlines—repair parts, equipment, finished items *keep moving* to where they're needed. Reach any U.S. point in hours. Phone local Air Express Division, Railway Express Agency, for fast shipping action. Specify "Air Express" on orders for quickest delivery.

FACTS on low Air Express rates

22 lbs. machine parts goes 700 miles for \$4.73.
10 lbs. printed matter goes 1000 miles for \$3.31.
30-lb. carton of new fashions goes 500 miles for \$4.61.
Same day delivery in all these cases if you ship early.

SPECIFY
AIR EXPRESS
GETS THERE FIRST



Rates include pick-up and delivery door to door in all principal towns and cities



AIR EXPRESS, A SERVICE OF RAILWAY EXPRESS AGENCY AND THE
SCHEDULED AIRLINES OF THE U.S.

NEW PRODUCTS

(continued)

is designed for operation from 220 or 440 volt, three-phase a-c, and has a flexible d-c output. Output voltage ripple content is about 5 percent.

Studio-Type Ribbon Mike

AMPERITE Co., INC., 561 Broadway, New York 12, N. Y. Frequency range of the new studio ribbon mi-

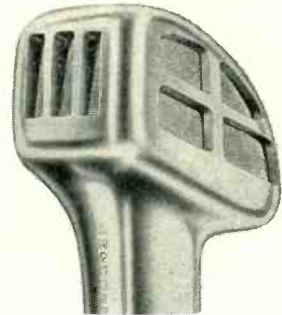

crophone models R80L & R80H is 40 to 14,000 cps; output is -56 db; harmonic distortion, less than 1 percent; discrimination with angle is 60 to 10,000 cycles. The unit is available in 200 ohms output, also in high impedance.

D-C Amplifier

MILLIVAC INSTRUMENTS, Box 3027, New Haven, Conn. Model DCA-1025 d-c amplifier has a 0 to 10 millivolt d-c input and 25 v, 1-milli-

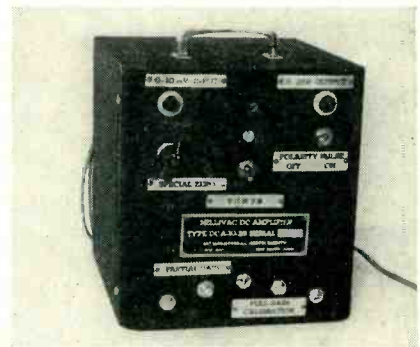

ampere or 5-volt 3-milliamper d-c output. Its applications are the same as those of the model MV-17A device but it can be used with either delicate or coarse output meters. Adjustable gain is included. A brochure gives further details.

Selenium Cell

INTERNATIONAL RECTIFIER CORP., 6809 South Victoria Ave., Los Angeles 43, Calif. The new type H selenium cells illustrated have a

maximum reverse voltage of 24 v rms with current ratings from 6 to 20 amperes depending upon the type of connection. Forward drop is about 1 volt. A brochure is available.

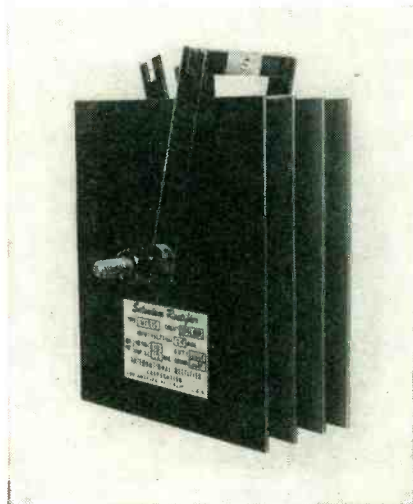

Miniature Controls

DAVEN Co., 191 Central Ave., Newark, N. J. A new line of attenuators with decreased dimensions is now in production. They are designed for use in equipment in which mounting space is limited and have the same mechanical and electrical construction as former units.

Speech Clipper

ELECTRO-VOICE, INC., Buchanan, Mich. Model 1000 Speech Clipper

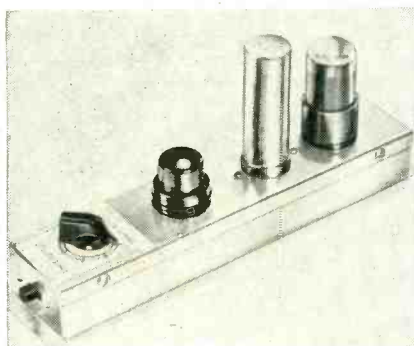

is a peak limiting preamplifier that clips the tops and bottoms from speech frequencies which rise above a preset amplitude, to provide higher articulation for communication services. Frequency response of the unit is from 200 to 3,000 cycles. Clipping is from 3 to 20 db.

Fidelity Speaker

RACON ELECTRIC CO., INC., 52 East 19th St., New York, N. Y. The Cel-

Shallcross ATTENUATORS

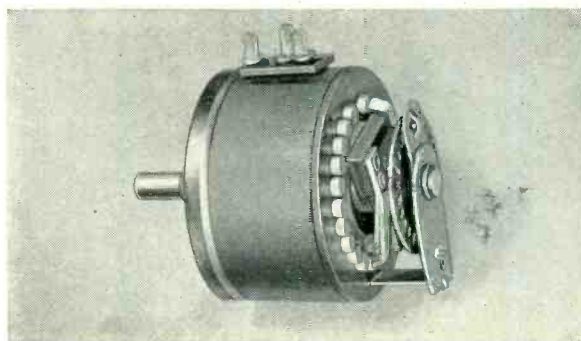

**BRIDGED 'T' ATTENUATOR
Type 410-4B1**

10 steps, 4 db/step. Linear attenuation with detent. 2 1/8" diameter, 2 1/8" depth.

\$11.50
LIST PRICE

**BRIDGED 'T' ATTENUATOR
Type 420-2B2**

20 steps, 2 db/step. Linear attenuation with off position and detent. 2 1/8" diameter, 2 1/8" depth.

\$16.00
LIST PRICE

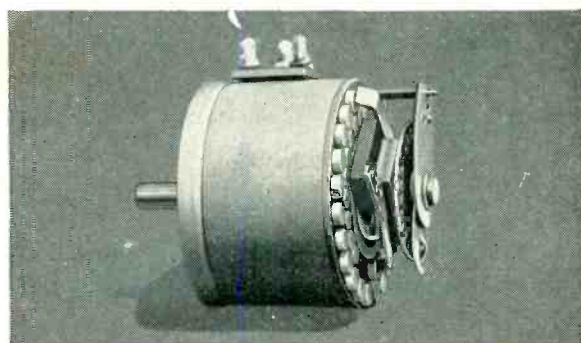

**POTENTIOMETER
Type C720-2A3**

20 steps, 2 db/step, tapered on last three steps to off, composition resistors. 1 3/4" diameter, 1 3/4" depth.

\$8.00
LIST PRICE

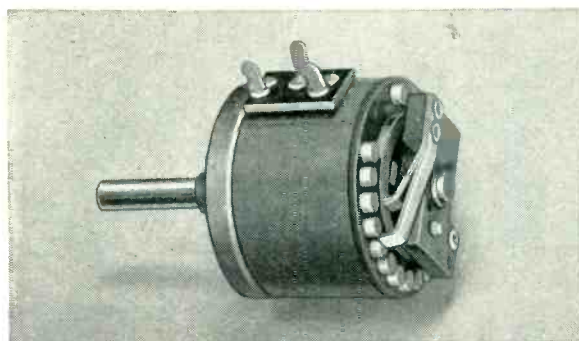

**These Shallcross Features
Mean Better Performance—
Better Value!**

Off position attenuation well in excess of 100 db.

25% to 50% fewer soldered joints.

Noise level ratings that are factual. (130 db. or more below zero level.)

Non-inductive Shallcross precision resistors used throughout assure flat attenuation to and beyond 30 kc.

Types and sizes engineered for all needs. Attenuation accuracies of 1%, Resistor accuracies of 0.1%, on special order.

**SHALLCROSS
ATTENUATORS**

Shallcross variable attenuators have proved their remarkable quietness and serviceability in dozens of applications for leading users in all parts of the world. Such important details as the use of spring-temper silver alloy wiper arms, silver alloy collector rings and contacts, non-inductive precision resistors, and sturdy, substantial mounting plates have made possible the high standard of performance attributed to Shallcross.

Standard types include ladder and bridged T mixer controls, bridged T and straight T master gain controls and V.U. meter multipliers, wirewound and composition potentiometers for grid control. Cueing attenuators, and fixed pads, both composition and wirewound, in all circuit configurations are also available.

Write for Catalog and Attenuator Specification Sheet

SHALLCROSS MANUFACTURING COMPANY
Department E-118, Collingdale, Pa.

ANOTHER
SPECIAL BY
PROGRESSIVE

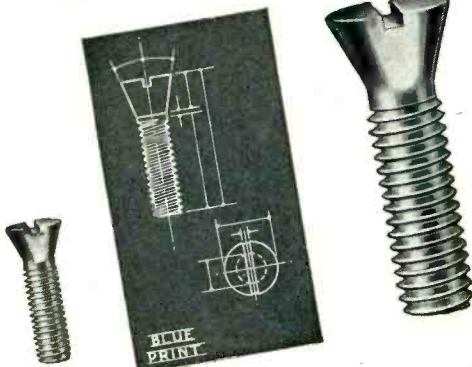

ACTUAL
SIZE

ENLARGED FOR DETAIL

CATALOG SHOWS DOZENS MORE

Special heads, threads and finishes on any metal or alloy adapted to cold upset. Weekly output: 25,000,000 pieces. Many specials, suggesting production savings for you, illustrated in latest catalog. Includes weights per 1M standard pieces, dec. equivs. of fractions, other purchasing and engineering helps. Write for Catalog 19.

The **PROGRESSIVE MFG. CO.**
TORRINGTON, CONN.
50 NORWOOD ST.

American Beauty

ELECTRIC SOLDERING IRONS

are sturdily built for the hard usage of industrial service. Have plug type tips and are constructed on the unit system with each vital part, such as heating element, easily removable and replaceable. In 5 sizes, from 50 watts to 550 watts.

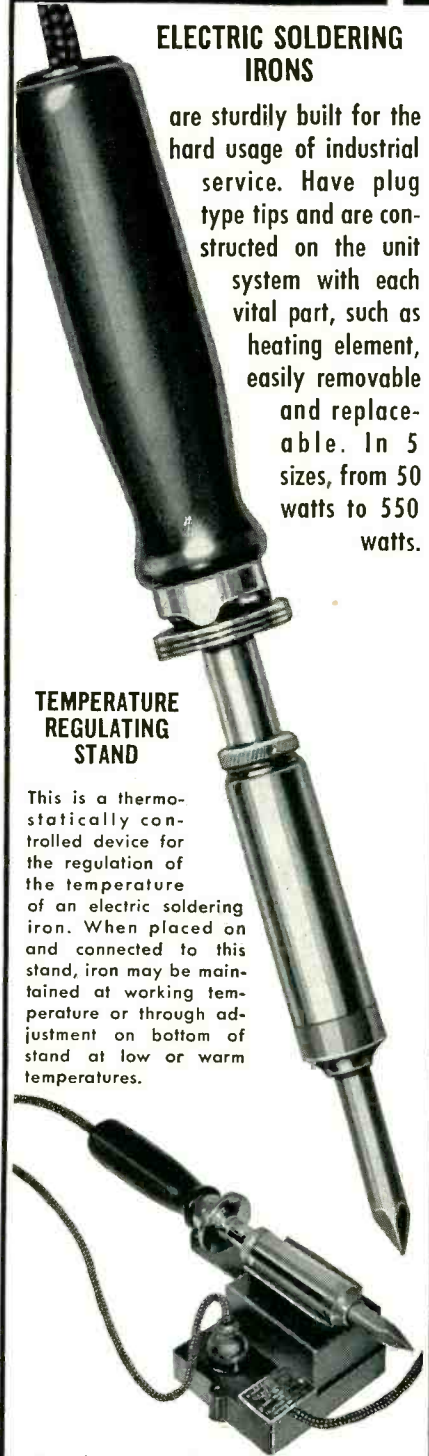

TEMPERATURE REGULATING STAND

This is a thermostatically controlled device for the regulation of the temperature of an electric soldering iron. When placed on and connected to this stand, iron may be maintained at working temperature or through adjustment on bottom of stand at low or warm temperatures.

Write for Catalog Sheets

110-1

**AMERICAN ELECTRICAL
HEATER COMPANY**
DETROIT 2, MICH., U. S. A.

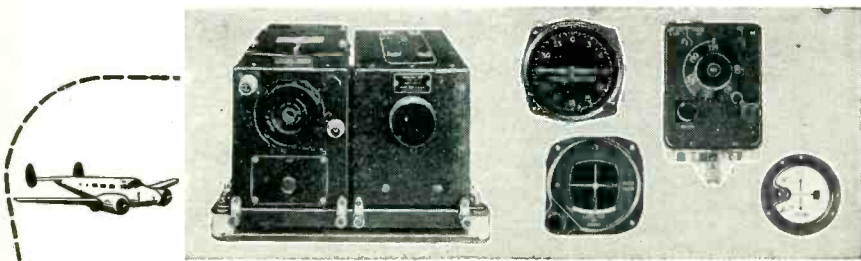

The Magic of **VHF**

Airborne Equipment for:

OMNI-DIRECTIONAL RANGES
RUNWAY LOCALIZERS
VISUAL-AURAL RANGES
SIMULTANEOUS VOICE
GCA VOICE RECEPTION

The Type 15A VHF Navigational Receiving Equipment (illustrated) provides for reception on the new Omni-Directional Ranges as well as operation on both types of VHF Runway Localizers, and the VHF Visual-Aural Airways Ranges. Simultaneous voice feature is included on these ranges. The *tunable* A.R.C. Receiver permits selection of any VHF aircraft frequency.

The A.R.C. Type 17 or A.R.C. Type 18 is the companion communication equipment normally associated with the Type 15A. The Type 17 VHF Communication Equipment adds independent two-way VHF communication facilities. The Type 18 adds VHF Transmitting Equipment only. All Type 17 and 18 units are type-certificated by the CAA.

The dependability and performance of these VHF Communication and Navigation Systems spells increased safety in flight. Specify A.R.C. for your next installation.



Aircraft Radio Corporation

BOONTON, NEW JERSEY

DEPENDABLE ELECTRONIC EQUIPMENT SINCE 1928

ular Grand has a new type cellular horn with horizontal distribution angle of 120 degrees and vertical distribution of 60 degrees. A resistive-capacitive filter network is included. Frequency range is 50 to 12,000 cycles.

Street Lighting Control

FISHER-PIERCE CO., INC., Boston 21, Mass. announces the series 63300

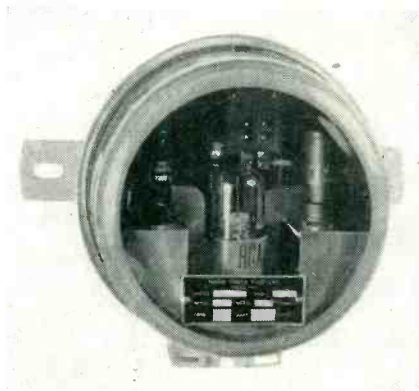

photoelectric street lighting control with a capacity of 3,000 watts of incandescent lamp load. Models are available for both 120 and 230 volts, 50-60 cycles. Standard turn-on adjustment is 0.5 foot-candle with turn-off at 1.25 foot-candles.

Interval Timer

HAYDON MFG. CO., INC., Torrington, Conn. A new multipurpose interval

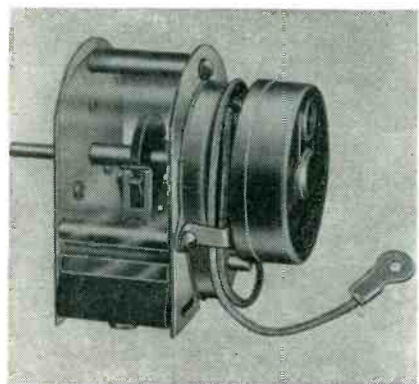

timer is now available in the 8006 series. Several different models in the series are used for varying applications such as multiple sequence switching.

Portable Picture Monitor

POLARAD ELECTRONICS Co., 9 Ferry St., New York 7, N. Y. Model 102-

For TV and FM



*Standardize
on One!*

Now, ONE crystal holder will cover your requirements for television and frequency modulation transmission. RH-7 hermetically sealed crystal units offer a frequency range from 1 to 75mc, to tolerances as close as $\pm .0002\%$. Space-saving, easily installed and replaced, RH-7 crystals will fit all circuits. Two pin sizes or wire leads are available.

Why not standardize now,
on just ONE!

REEVES HOFFMAN

C O R P O R A T I O N

CHERRY AND NORTH STREETS • CARLISLE, PA.

It's here!

The NEW General Electric Variable Reluctance Cartridge for Long Playing Records

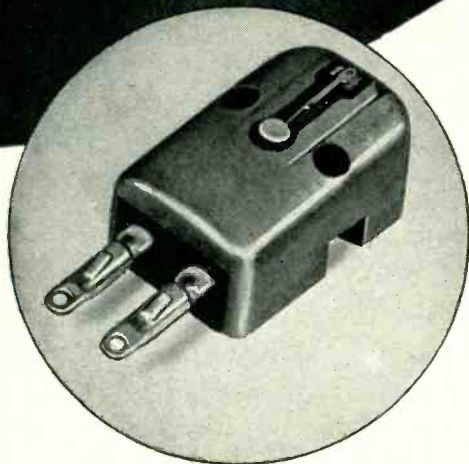

- Specifically designed for the new long playing records . . . high compliance . . . low mass stylus assembly
 - Equipped with 1 mil tip radius sapphire stylus
 - Can be used with standard G-E preamplifiers
- Place your order today!

*General Electric Company, Electronics Park,
Syracuse, New York*

168-G10A

You can put your confidence in—
GENERAL  ELECTRIC

NEW PRODUCTS

(continued)

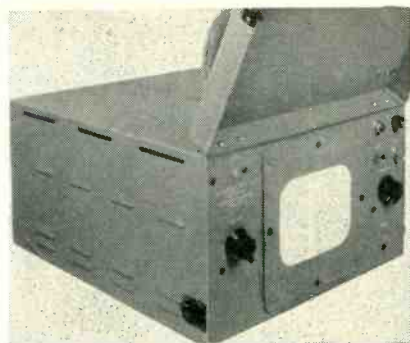

MPS portable television picture monitor has a maximum resolution in excess of 500 lines and employs a 7-inch electromagnetic deflection picture tube. The equipment operates with a minimum video input signal 1 volt peak-to-peak.

Line Match Indicator

AERONAUTICAL COMMUNICATIONS EQUIPMENT, INC., 3090 Douglas Road, Miami, Florida. Model LMI-



500 illustrated is a device for aiding adjustment of load for optimum line match at frequencies from 0.2 to 2 mc, or 2 to 20 mc. Model LMI-72 is used for coaxial lines at frequencies between 0.2 and 10 mc.

Rotary Beam Calculator

GORDON SPECIALTIES Co., 542 S. Dearborn St., Chicago 5, Ill. Dimensions for various types of beam antennas to operate in the region between 10 and 30 megacycles can be found quickly with a new calculator. Values for capacitance and inductance required for resonance between 5 and 60 mc are given, along with other information such as length of supporting boom required for various arrays. Price direct is \$1.60 which includes postage.

Cable Reel

INDUSTRIAL ELECTRICAL WORKS, 1509 Chicago St., Omaha 2, Ne-

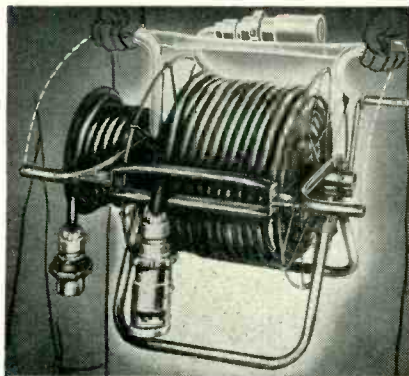

braska. With a capacity of 300 feet of 3/4-inch four-conductor cable, or equivalent, the Powereel illustrated can be used for all types of cables. Each reel has either three or four collector rings of beryllium copper with double contact copper brushes.

Transducers

KOLLSMAN INSTRUMENT DIVISION, 80-08 45th Ave., Elmhurst, N. Y. Important in flight testing and con-

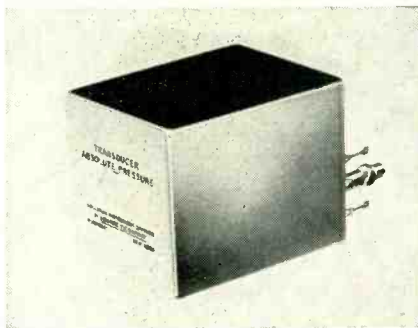

trol applications for pilotless aircraft the new, small transducers, one of which is illustrated, provide means of obtaining electrical signals that are functions of air speed, altitude, differential pressure, and gage pressure.

Dynamic Micrometer

ELECTRO PRODUCTS LABORATORIES, INC., 549 W. Randolph St., Chicago 6, Ill., has developed a dynamic mi-

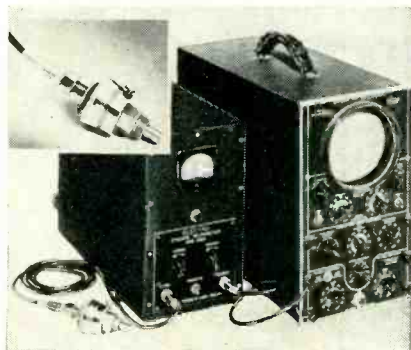

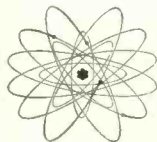
a leash
for
atomic 
energy



... the end result of C-T metallurgy teamed with the engineering ingenuity of Radiation Counter Laboratories, Inc.

The Geiger Muller counter* is no stranger to the electronics engineer. Its sensitivity is beyond the realm of mathematical definition. But not so well-known are the difficulties encountered in producing a tube that is as sturdy as it is sensitive.

And that is where we, as metallurgical specialists, have been of more than usual assistance to design engineers.

If you use components of tungsten, molybdenum, silver, platinum, palladium or alloys of these metals consult with our engineers. Conceivably, from the wealth of our experience we may be able to help you produce your product more economically.

Catalog No. 156 on request.

Callite Tungsten Corporation
544 Thirty-ninth St., Union City, N. J.

*Manufactured by the well-known Radiation Counter Laboratories, Inc. of Chicago.

Callite
Tube Components

Hard glass leads, welds, tungsten and molybdenum, wire, rod, sheet, formed parts, and other materials for incandescent lamps and electronic tubes.

GRAY TRANSCRIPTION ARMS and EQUALIZERS

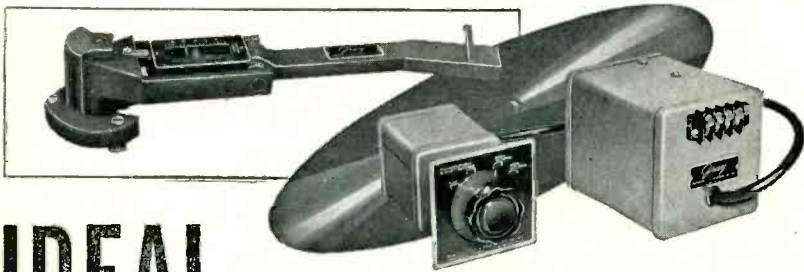

IDEAL for the New LP Records

The GRAY TRANSCRIPTION ARM 103-LP, with Selected GE Variable Reductance Cartridge with 1 mil Diamond Stylus, has been especially designed for use with the new LP Micro-Groove Records. Due to such features as **adjustable stylus pressure, frictionless motion, self-leveling base** and **the accommodation of any standard cartridge**, arm obsolescence is precluded. Arm, with 1 mil Diamond Stylus Cartridge, \$77.95.

The GRAY #601 4-position EQUALIZER for GE Cartridge, finest performance and workmanship, ideal response curves. Adopted by radio networks. Matches pickup to microphone channel. Complete, \$49.50.

Inquiries invited for development and manufacturing.

GRAY RESEARCH & DEVELOPMENT COMPANY, Inc.

16 ARBOR STREET

HARTFORD 1, CONN.

- more compact, higher accuracy!

TYPES WL $\frac{5}{8}$ " and WLA $\frac{5}{8}$ "



**1/2 WATT
INDUCTIVE**

MAX. RES: .01 to 7,500 ohm (331 Alloy)
.01 to 4,000 ohm (Nichrome)
.01 to 1,250 ohm (Manganin)

BODY SIZE: $\frac{5}{8}$ " lg. by $\frac{3}{16}$ " diam.

TOLERANCE: STANDARD 1%

TYPES WL and WLA



**1 WATT
INDUCTIVE**

MAX. RES: .01 to 15,000 ohm (331 Alloy)
.01 to 8,000 ohm (Nichrome)
.01 to 2,500 ohm (Manganin)

BODY SIZE: 1" lg. by $\frac{3}{16}$ " diam.

TOLERANCE: STANDARD 1%

Can be supplied non-inductive with one-half indicated maximum resistance.

Economical in Cost

IN-RES-CO WL series resistors were designed to meet increasing demands for a compact resistor of high accuracy priced for general use. They meet the most critical requirements—close tolerance, ability to withstand overload, long life. Write today for catalog describing the full line of quality IN-RES-CO resistors.

IN-RES-CO
APPLICATION-DESIGNED
RESISTORS



INSTRUMENT RESISTORS CO., 1056 COMMERCE AVE., UNION, N. J.

3 1/2 KW VACUUM TUBE BOMBARDER or INDUCTION HEATING UNIT



Only \$975

Never before a value like this 3 1/2 KW bombarder or high frequency induction heater . . . for saving time and money in surface hardening, brazing, soldering, annealing and many other heat treating operations. Is

Portable . . . mounted on four rubber coasters. Width 14 1/2"; depth 27"; height 42 1/2"; weight 300#.

Operates from 220 volt line. Complete with foot switch and one heating coil made to customer's requirements. Send samples of work wanted. We will advise time cycle required for your particular job. Cost, complete, only \$975. Immediate delivery.

Scientific Electric Electronic Heaters are made in the following ranges of power: 1-2-3-5-7 1/2-10-12 1/2-15-18-25-40-60-80-100-250. KW.

*Scientific
Electric*

Division of

"S" CORRUGATED QUENCHED GAP CO.

105 - 119 Monroe St., Garfield, N. J.

rometer for measuring movement, radial displacement, or vibration of any part made of ferrous material. Displacement is read in tenths of a thousandth of an inch and accuracy is the same for a static condition as for a dynamic condition corresponding to speeds up to 200,000 rpm. Total weight is 27 pounds.

Wavemeter

SIMPSON ELECTRIC Co., 5218 West Kinzie St., Chicago 44, Ill. Model

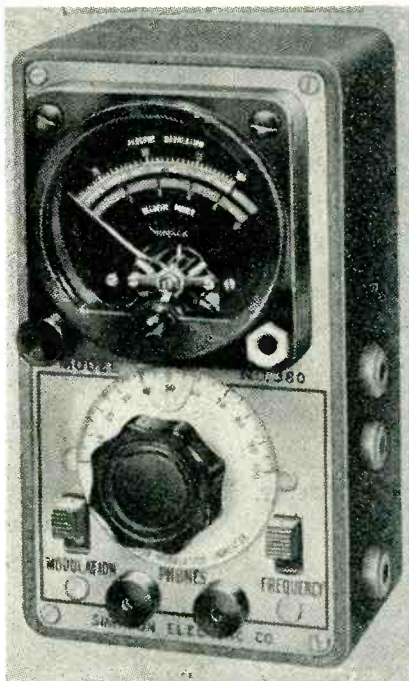

380 wavemeter is a pocket-size instrument for use by amateurs, ships, police radio, and similar services. Provision is also made for checking percentage of modulation. Separate coils are provided for the 10 to 80-meter amateur bands. A 2-foot antenna is furnished to be plugged into a jack on the instrument. Frequencies as high as 420 megacycles can be checked.

Flexible Waveguide

AIRTRON, INC., 650 Bloomingdale Road, Staten Island, N. Y. A new type of convoluted bellows electro-

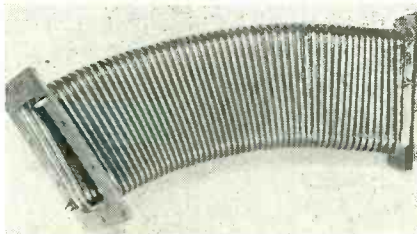

Winner by a Landslide!



**The TURNER
MODEL 20X**



MODEL S20X
Equipped with convenient slide-lock switch for on-off operation.



MODEL SR20X
Equipped with built-in push-to-talk relay switch and cable.

High performance at low cost

On every count the new Turner Model 20X has won the vote of users. Response to voice and music pickups is smooth and even over a desired range of frequencies. Output level is remarkably high. Engineered for dependable service indoors or out with high quality moisture sealed crystal circuit. Light in weight, natural to hold, and most convenient to use. It is equipped with hook ring for hanging. Attractive case is finished in rich baked brown enamel. And the price, complete with 7 ft. cable is exceptionally low.

Write for Complete Microphone Literature

THE TURNER COMPANY
905 17th Street N. E. Cedar Rapids, Iowa

Crystals licensed under patents of the Brush Development Co.



Microphones **BY TURNER**

At long last—

The G.M. counter tube reaches maturity
in the new all metal ***THYRODE 1B85**

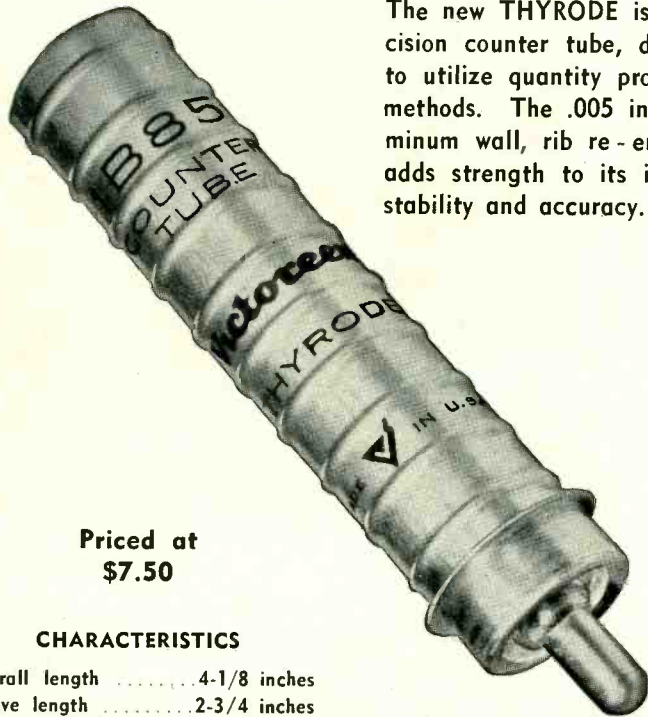

Priced at
\$7.50

CHARACTERISTICS

Overall length 4-1/8 inches
Active length 2-3/4 inches
Shell diameter 3/4 inches
Absorption 30 mgm/cm²
Operating voltage 900 volts
(center of plateau)
Plateau length 200 volts
Plateau slope 3% / 100 volts
Temperature range 5° C. to 70° C.
Life 10⁸ counts

The new THYRODE is a precision counter tube, designed to utilize quantity production methods. The .005 inch aluminum wall, rib re-enforced, adds strength to its inherent stability and accuracy.

***THYRODE**

A Victoreen trademark for radiation counter tubes

Victoreen radiation measuring instruments for laboratory and field determinations together with such components as the VX series subminiature electrometer tubes, vacuum sealed hi-meg resistors and G-M counter tubes have made notable contributions to the present refinement of radiation instrumentation.

Victoreen 5806 Hough Avenue
Cleveland 3, Ohio

plated flexible waveguide is now available having an electrical impedance matching that of rigid waveguide. Sizes down to that required for 1 cm can be supplied.

Alpha Counter

INSTRUMENT DEVELOPMENT LABORATORIES, INC., 223 West Erie St., Chicago 10, Ill. Model 117 alpha



counter will count alpha particles in the presence of a strong beta background. Unit consists of a methane flow proportional counter, high-gain amplifier, scaler (256 to 1), impulse recorder, and variable high-voltage supply.

Phone Plug

SWITCHCRAFT, INC., 1328 N. Halsted St., Chicago 22, Ill. The Little-

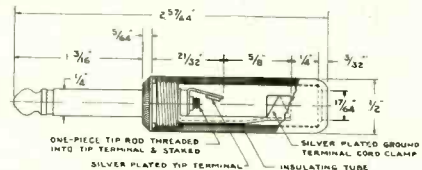

Plug illustrated features a sleeve terminal that can be clamped over the metal braid of shielded wire cables to form both mechanical anchor and electrical connection. If the terminal is used only for mechanical anchorage an extra lug can be used for connection to the sleeve of the plug.

Blowers

JOHNSON FAN & BLOWER CORP., 1319 W. Lake St., Chicago 7, Ill. Type 5CB centrifugal fans have a

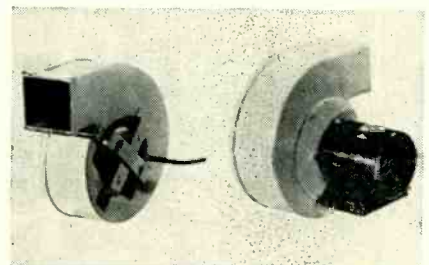

wheel diameter of 5 inches. Various sizes of motors and different fan combinations can be furnished for many applications in cooling electrical and electronic equipment.

Multiple Control Unit

WELTRONIC Co., 19446 W. Eight Mile Road, Detroit 19, Mich. Model 312KS2, a 3-phase multiple control combination, has a remote control

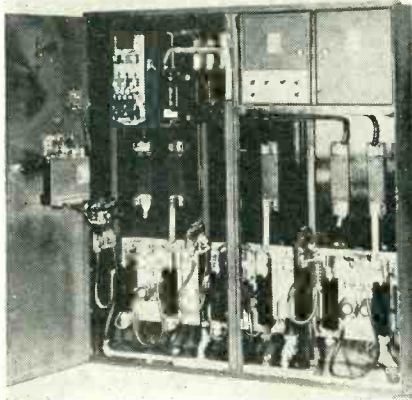

relay timer which provides a variety of multiple welding sequences with independent dial adjustment of weld time on each phase. Automatic control circuit protection is incorporated. Write for detailed information on standard and supplementary equipment.

Plug-Tip Soldering Iron

HEXACON ELECTRIC Co., 130 W. Clay Ave., Roselle Park, N. J.



Model P212 electric soldering iron is rated at 200 watts with a half-inch diameter tip.

Literature

C-R Tube Primer. Allen B. DuMont Labs., Inc., 1000 Main Ave., Clifton, N. J. A 63-page manual presents an excellent non-technical discussion of the cathode-ray tube and its functions. The book is available without cost to anyone professionally engaged in electronics or teaching the sub-

"Telepak"



The FLEXIBILITY

*that keeps
in step
with
Progress*

THE problem of meeting new power and frequency requirements in communications systems, with minimum obsolescence, is solved by the Telepak line of transmitting equipment, the latest achievement in this field by Radio Receptor.

Telepak consists of a basic frame supporting a series of separately and easily removable units or cells of standard construction, varying in height according to power requirements. These unit assemblies are housed in standard cabinets, as illustrated.

Any cell may be easily removed to permit servicing or replacement by a new unit of different function or frequency. This adaptability offers another advantage as it permits the combination of units of all ratings in a single installation. Units are available in power output ratings varying from 500 watts to 3 kilowatts.

Remote control elements are also on the unit cell basis, and are capable of expansion along with other elements in the system.

It will pay you to look into the many exclusive features of Telepak, Radio Receptor's new transmitting system that enables you to keep in step with Progress.

Write for the new Telepak Handbook containing information of value to every engineer. Address Department C-10

Communications Division
RADIO RECEPTOR COMPANY, INC.
 Since 1922 In Radio and Electronics
 251 WEST 19th STREET • NEW YORK 11, N. Y.

Designed for

Application



92105

THE NO. 92105
"SSSR"

Single Sideband Selector

The No. 92105 is designed to permit Single Sideband Selection with existing receivers. Full technical details in April 1948 QST. Produced in co-operation and under exclusive U. S. patent license (2,364,863 and others) with the J. L. A. McLaughlin Research Laboratories.

JAMES MILLEN
MFG. CO., INC.

MAIN OFFICE AND FACTORY
MALDEN
MASSACHUSETTS



NEW PRODUCTS

(continued)

ject, and others may obtain it at 50 cents per copy, or at \$2.50 in lots of a dozen.

Data Handling Systems. Tele-register Laboratories, 157 Chambers St., New York 7, N. Y. The engineering services available for teleregister systems covering everything from parimutual totalizers to inventory and production control are described and representative equipment is illustrated in a 24-page booklet.

Motor Speed Control. Servomechanisms Inc., Mineola, N. Y. The new motor speed control SC104 provides a speed range of 40 to 1 for armature output of 5,000 rpm maximum. Torque-versus-speed curves are given in a page descriptive sheet.

Connector Catalog. American Phenolic Corp., Chicago 50, Ill. Catalog A-1 on AN connectors and fittings for power, signal, and control circuits, lists thousands of sizes and graphically illustrates the different types of shells and insert arrangements available for each. Dimensions and electrical data are shown in detail.

Magnetic Tape Recorders. Ampex Electric Corp., 681 Fifth Ave., New York 22, N. Y. An 8-page booklet describes and illustrates chief features of the model 200-A magnetic tape recorder. The unit has already been tested on continuous commercial network operation.

Tube Information. Radio Corp. of America, Harrison, N. J. Technical data on types 6BA7 and 12BA7 pentagrid converters has been published, as well as application notes on receiver sensitivity measurements at high frequencies, and a brochure on improved arrangement of base pin connections in new miniatures.

Attenuator Pad. Weinschel Engineering Co., 123 William St., New York 7, N. Y., has issued a folder describing the model 50-L/p-x coaxial attenuator pad with atten-

TRACING CLOTH
for
HARD PENCILS

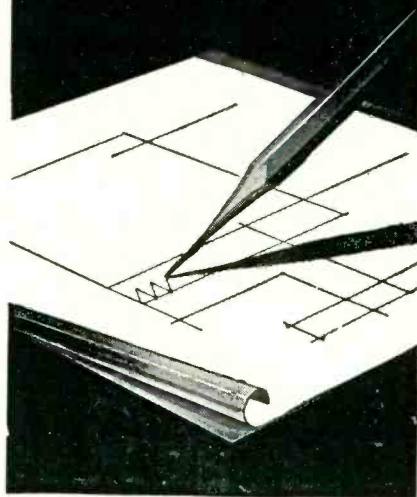

● Imperial Pencil Tracing Cloth has the same superbly uniform cloth foundation and transparency as the world famous Imperial Tracing Cloth. But it is distinguished by its special dull drawing surface, on which hard pencils can be used, giving clean, sharp, opaque, non-smudging lines.

Erasures are made easily, without damage. It gives sharp, contrasting prints of the finest lines. It resists the effects of time and wear, and does not become brittle or opaque.

Imperial Pencil Tracing Cloth is right for ink drawings as well.



IMPERIAL
PENCIL
TRACING
CLOTH



SOLD BY LEADING STATIONERY AND
DRAWING MATERIAL DEALERS EVERYWHERE.

uation between 5 and 25 db and a 50-ohm characteristic impedance. Specifications are included.

Tube Data. General Electronics, Inc., 101 Hazel St., Paterson, N. J. A recently issued folder gives technical data for a large line of transmitting tubes, rectifiers and vacuum capacitors. Prices are also listed.

Recording Wire. Fidelitone Inc., 1616 Devon Ave., Chicago 26, Ill. Bulletin No. 9 gives informative and semitechnical data comparing the 0.004 and 0.0036-inch diameter wire for magnetic wire recording.

Electrical Insulation. Insulation Manufacturers Corp., 565 West Washington Blvd., Chicago 6, Ill. Outstanding features of the Dieflex varnished tubings or sleeveings are set forth on two sides of a sheet. A variety of grades and sizes of the products may be obtained.

Radio Link Equipment. Federal Telecommunication Laboratories, Inc., 67 Broad St., New York 4, N. Y. Special features, illustration and general description, and technical characteristics of a variety of radio link equipment, a monitor, and dummy load are treated in five loose-leaf folders now available.

Quartz Crystals. Reeves-Hoffman Corp., Carlisle, Pa. Bulletin RHC-X covers an assortment of crystal units ranging from 50 ke to 100 mc. Ordering instructions are included.

Automatic Controls. Leeds & Northrup Co., 4934 Stenton Ave., Philadelphia 44, Pa., has issued a newly-revised, 40-page catalog on position-adjusting and electrically-actuated control equipment. Both Micromax and Speedomax instruments are listed. Ask for catalog ND4A (1).

Tube Catalog. Amperex Electronic Corp., 25 Washington St., Brooklyn 1, N. Y. The new 296-page

Investigate COPPER ARMORED SISALKRAFT

Reinforced with tough



Sisal Fibres

for electrostatic shielding of
**TELEVISION AND RADIO STUDIOS, TESTING ROOMS,
INDUSTRIAL LABORATORIES, AND DIATHERMY, RADAR
AND ELECTRONIC EQUIPMENT**

The success of COPPER ARMORED SISALKRAFT for shielding during the past decade suggests that you might find this reinforced "electro sheet copper" product practical for rooms and large enclosures or equipment requiring electrostatic shielding.

SISALKRAFT engineers do not presume to be authorities on this complex subject. We shall be glad to cooperate, however, on the basis of experience gained in such installations as:

- Steinmetz Hall, New York • Hollywood Television Studio of Don Lee WBKB Radio Station, Chicago • Sentinel Television Testing Rooms
- Corn Products Company's Argo Laboratory • Delco Radio Sets
- CBS Radio Testing Laboratories

... and other applications that indicate the merit of COPPER ARMORED SISALKRAFT in these and allied fields.

COPPER ARMORED SISALKRAFT is available in 1-oz., 2-oz., and 3-oz. weights, in rolls 4" to 60" wide. Reasonable cost . . . as low as \$9.75 per 100 square feet. Send for samples.

COPPER ARMORED SISALKRAFT

• • **A Product of.** • • • • •



THE SISALKRAFT CO., Chicago 6 • New York 17 • San Francisco 5

The SISALKRAFT Co., 205 W. Wacker Drive, Dept. E-2, Chicago 6, Ill.
Please send samples of One-Ounce; Two-Ounce; Three-Ounce COPPER ARMORED SISALKRAFT. The use I contemplate involves (describe briefly)

.....

Name.....

Address.....

City, Zone No. and State.....

✓ Check
these outstanding
IMPROVEMENTS

ADC
JACKS

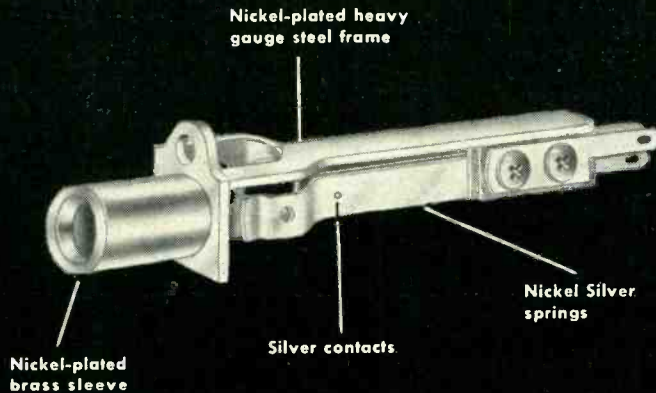

**Now you get
ALL THESE BENEFITS**

ALL ADC JACK
PANELS NOW CONTAIN
THESE NEW ADC JACKS

- Greater Strength & Rigidity!
- Less Corrosion!
- Better Contacts!
- Longer Life!

See Your Jobber
or write today for
ADC CATALOG

The new streamlined design of ADC Jacks uses heavier gauge metal for *greater strength*. The frame is die-formed and press-welded for utmost rigidity and dimensional accuracy.

Silver-alloy contacts and genuine Nickel Silver springs guarantee corrosion resistance, even under the most humid conditions.

All the way through, the new ADC is a better jack! If you require top quality and precision-made components, ADC Jacks merit your *first* consideration.

ADC

Audio DEVELOPMENT CO
Audio Develops the Finest
2847 13th AVE. SOUTH · MINNEAPOLIS 7, MINN.

catalog covers a line of electronic tubes for communications, industrial, amateur, and electromedical uses. Contents are grouped under four headings: air-cooled power tubes, water and forced-air cooled power tubes, rectifier tubes, and vacuum capacitors. Full data are given on each tube. A formal request to Amperex will bring your copy to you.

Magnetic Sub-Assemblies. General Electric Co., Chemical Dept., Pittsfield, Mass. Booklet CDM-16 describes and illustrates a line of permanent magnet sub-assemblies for engineering and production economy. Ordering instructions are included.

Sound Products Catalog. Radio Corp. of America, Engineering Products Department, Camden, N. J. Catalog 218P lists in 84 pages a complete line of sound equipment. Concise descriptions of each model include such information as special features, uses, specifications, photographs and diagrams.

Electrical Tapes. Minnesota Mining & Mfg. Co., 900 Fauquier Ave., St. Paul 6, Minn., announces a new 24-page two-color catalog describing 39 Scotch brand electrical tapes. Tape properties are listed and eighty-six applications illustrated.

Radioteletype Converter. George J. Maki, Radioteletype Engineering, Moraga, Calif. Description, block and circuit diagrams, and specifications of the model RC-55 frequency-shift radioteletype converter may be found in a new booklet.

Vacuum Measurement. George E. Fredericks Co., Bethayres, Pa., has available a new 28-page booklet on vacuum measurement. Written in nontechnical language, it is intended for the layman interested in the proper selection and use of vacuum gages for industrial processes.

GIVE YOUR FAMILY
THIS GIFT OF A LIFETIME
AN ALTEC LANSING
home music system

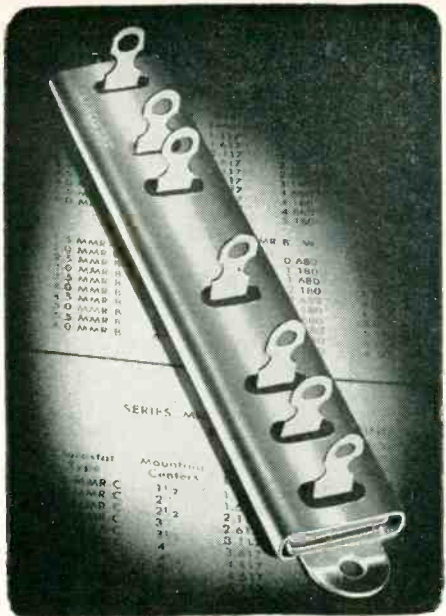

**VOLTAGE
DIVIDERS**

★ Clarostat Series MMR bakelite-insulated metal-clad resistors run definitely COOLER than any other similar types, SIZE FOR SIZE. Or putting it another way, these strip resistors will DISSIPATE MORE POWER for the same temperature rise, SIZE FOR SIZE.

Hundreds of thousands in daily use! They tell their own story!

Resistance values from fraction of ohm to 15,000 ohms per winding inch. In standard, inverted and vertical mounting types. Any number of intermediate taps within reason. 5 watts per winding inch mounted on metal radiating surface; 2½ watts in free air.



Engineering Bulletin 109 on request. Let us quote.

Controls and Resistors

CLAROSTAT MFG. CO., Inc - - - DOVER, N. H.

In Canada: CANADIAN MARCONI CO., Ltd. Montreal, P. Q., and branches

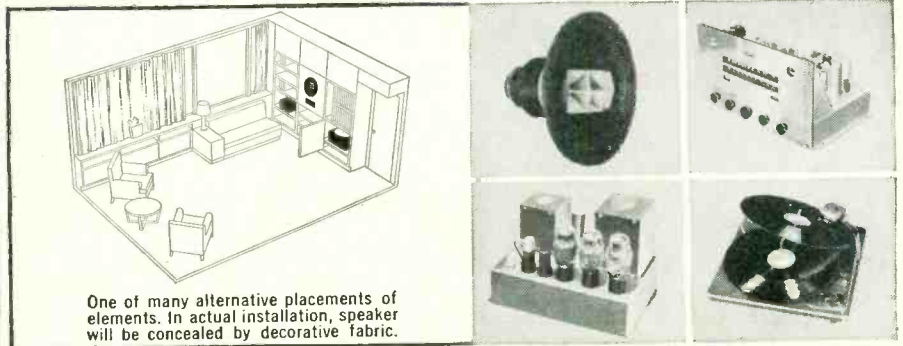

One of many alternative placements of elements. In actual installation, speaker will be concealed by decorative fabric.

As an engineer with professional knowledge of the science of audio reproduction, you can appreciate more thoroughly than any layman the incredible life-like reproduction of voice and music of which this magnificent Altec Lansing Home Music System is capable. Added to the lifetime enjoyment which this system will provide is the pleasure of installing it yourself. Full instructions are included. This system transcends the inherent limitations of commercial radio-

phonographs, yet costs are favorable to this system. The system includes the famous Altec Lansing Duplex speaker, a special Altec Lansing amplifier, a newly designed TRF Altec Lansing tuner, and the Webster 70 changer. Built-in Altec Lansing Daylight Television can also be included.

A brochure will be sent on request.

ALTEC
LANSING
*custom-in-built
home music system*

161 Sixth Avenue,
New York 13, N. Y.
1161 N. Vine Street,
Hollywood 38, Calif.



Over 20 years of fabricating experience

**PLASTIC
FABRICATING**

BAKELITE
SHEETS, RODS, TUBES.
BAKELITE AND FIBRE FABRICATED PARTS.
PUNCHING, DRILLING, MILLING
AND ENGRAVING

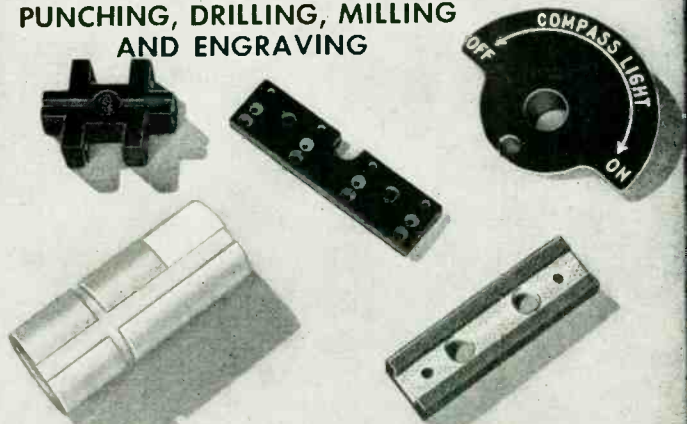

Mail Us Your Prints or Samples for Quotations

ELECTRICAL INSULATION CO., INC.
12 VESTRY ST., NEW YORK 13, N. Y.

Crystals for the Critical

STABILIZED CRYSTALS TO MEET EVERY NEED

Whatever your crystal needs, James Knights Co. is equipped to satisfy them quickly and economically.

To effect greater savings for you on short runs, a special production system has been established.

We are also equipped to quickly build "Stabilized" crystals to your exact specifications. In addition, James Knights Co. fabricates a complete line of "Stabilized" crystals to meet every ordinary need—precision built by the most modern methods and equipment.

For quality—speed—economy, contact the James Knights Co. You'll be glad you did!

New James Knights Catalog On Request

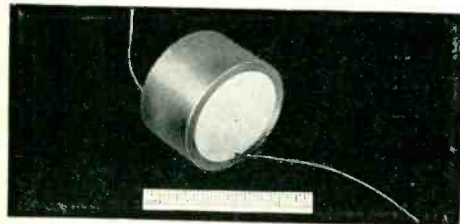

A university physicist wanted a 2" supersonic X-cut crystal. The James Knights Company made it promptly, and has since delivered many other special crystals for the same university.

The JAMES KNIGHTS Co.

SANDWICH, ILLINOIS



NEWS OF THE INDUSTRY

(continued from p 134)

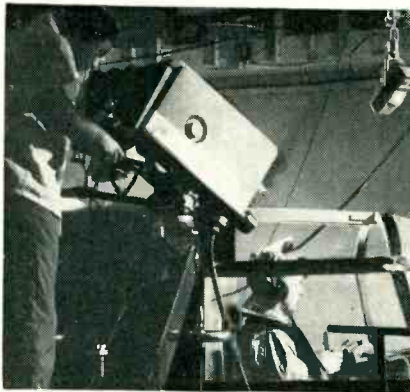

Televising cockpit mockup of P2V Neptune during Navy flight training lecture. Studio has two GE cameras like this and two DuMont cameras

vision receivers of various types will be used under a variety of conditions and with screen sizes ranging from that of a 10-inch tube on up to that projected onto a 9 by 12-foot screen. Also under investigation will be methods of instruction best adapted to the television medium and the design of the ideal television classroom. Tryouts of talk-back circuits are contemplated, so that students anywhere in widely scattered classrooms can ask questions of the instructor during or after a lecture.

Advantages of Television

With television, lectures by the Navy's best instructors can be presented to as many students as desirable, all at one time. During emergencies or accelerated wartime training programs, increased utilization of top notch men would justify holding them for training purposes, where they can do more good than on combat assignments.

Lectures and demonstrations of newly developed devices can be presented immediately by television, with no passing on of training from one instructor to another. If necessary, the pilot model itself can be used for demonstration. Since only one demonstration device is needed, more money can be spent on its development and construction. Security can be maintained by guarding coaxial terminal points and by scrambling the r-f signal, where necessary.

Television training gives every student a front-row seat, where he can see every movement of the in-

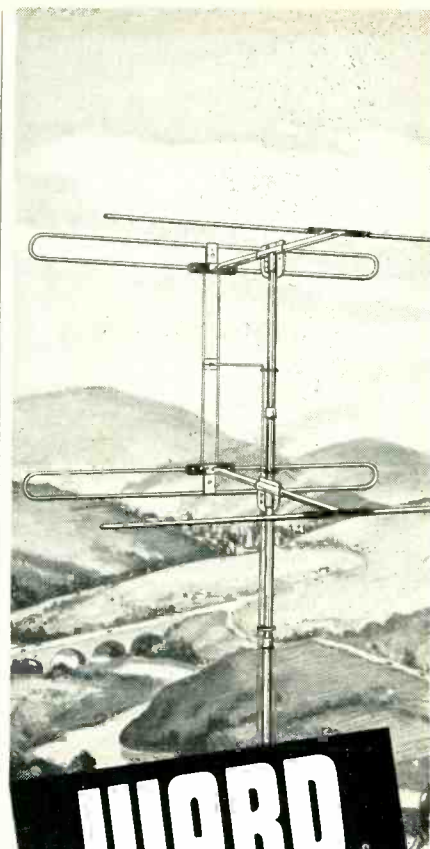

WARD

Magic Wand
ANTENNAS

**THE ONLY BROAD BANDED,
HIGH GAIN, STACKED ARRAY
ON THE MARKET**

Many times more sensitive for TV reception in fringe areas and poor signal locations, the WARD TVS-6 STACKED ARRAY achieves maximum forward gain by stacking two high gain folded dipoles and reflectors with effective $\frac{1}{2}$ wave spacing rather than the ordinary $\frac{1}{8}$ or $\frac{1}{4}$ wave which materially reduces sensitivity. **THE ONLY STACKED ARRAY ON THE MARKET THAT IS BROAD BANDED**, it will give excellent results with **MANY CHANNELS** where others are too selective. The advanced engineering and **PRE-ASSEMBLED** design of the WARD TVS-6 is only one of the reasons why WARD is the largest exclusive manufacturer of antennas in the world. See any leading parts distributor or write for catalog.

THE WARD PRODUCTS CORPORATION

1523 E. 45TH STREET, CLEVELAND 3, OHIO.

Save Time... Speed Assembly
with CTC ALL-SET Boards!



On the assembly line and in the laboratory, CTC ALL-SET Boards are valuable time-savers.

With Type 1558 Turret Lugs, a new board now offers mounting for miniature components. 1 1/16" wide, 3/32" thick, only. (Type X1401E.)

With Type 1724 Turret Lugs, boards come in four widths: 1/2", 2", 2 1/2", 3"—in 3/32", 1/8", 3/16" thicknesses.

With the addition of the new miniature board, CTC ALL-SET Boards now cover the entire range of components.

All boards are of laminated phenolic, in five-section units, scribed for easy separation. Each section drilled for 14 lugs. Lugs solidly swaged into precise position... whole board ready for your assembly line.

SPECIAL PROBLEMS

Custom-built boards are a specialty with CTC. We're equipped to handle many types of materials including the latest types of glass laminates... many types of jobs requiring special tools... and all types of work to government specifications. Why not drop us a line about your problem? No obligation, of course.

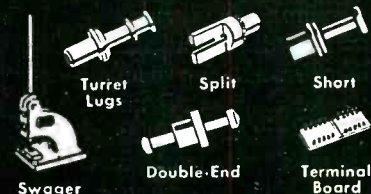

Custom or Standard
The Guaranteed
Components.

CAMBRIDGE THERMIONIC CORPORATION

437 Concord Avenue, Cambridge 38, Mass.



PILOT LIGHT ASSEMBLIES

PLN SERIES—Designed for
NE-51 Neon Lamp



Features

- THE MULTI-VUE CAP
- BUILT-IN RESISTOR
- 110 or 220 VOLTS
- EXTREME RUGGEDNESS
- VERY LOW CURRENT

Write for descriptive booklet

The DIAL LIGHT CO. of AMERICA

FOREMOST MANUFACTURER OF PILOT LIGHTS

900 BROADWAY, NEW YORK 3, N. Y.

Telephone—SPring 7-1300

NATIONAL MOLDITE MOLDED IRON CORES

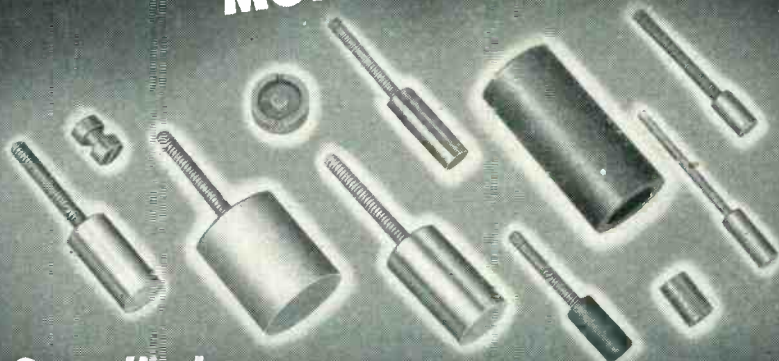

Supplied to your
EXACT SPECIFICATION



Moldite iron cores for television, FM, AM and audio frequencies are manufactured with the most advanced techniques to your exact mechanical and electrical specifications. New formulae and carefully supervised production result in higher Q values, permanent stability and quantity deliveries to meet your needs. When Moldite iron cores are designed into your circuit, you are assured of maximum performance, smaller physical size, reduced costs, proven reliability. Write for Catalog 102.

NATIONAL MOLDITE COMPANY
HILLSIDE • NEW JERSEY

MID-WESTERN REP.
IRV ROSE
314 NO. MICHIGAN AVE.
CHICAGO, ILL.

WESTERN REP.
PERLMUTH-COLMAN & ASSOC.
1335 SO. FLOWER ST.
LOS ANGELES, CALIF.

SO. AMERICAN REP.
JOSE LUIS PONTET
CORJOBA 1472
BUENOS AIRES, ARGENTINA

ENGINEERING SERVICE

Moldite engineers will gladly cooperate in determining the exact solution to your iron core problems for your design and production requirements.

SAMPLES

Sample iron cores will be submitted for design, test and pre-production purposes.



For **LONG**

TROUBLE-FREE OPERATION

Specify

N·W·L

CUSTOM-BUILT TRANSFORMERS

Over 25 years' experience in the manufacture of specials at cost that compares favorably with standard types. Built-in quality proved by years of actual use.



From 10VA to 300 KVA Dry-Type Only, Both Open and Encased, 1, 2, & 3 Phase 15 to 400 Cycles.

PROMPT DELIVERIES!

NOTHELFER WINDING LABORATORIES

9 ALBERMARLE AVE., TRENTON 3, N. J.

NEW BARRY CATALOG

Describing Equipment and Methods Used in Shock and Vibration Control

Many Designers and Engineers will use this Barry Catalog as a reference book. It contains Fundamental Vibration Charts, describes basic problems in shock and vibration control.

The new catalog illustrates and describes Barrymounts and their applications.

BARRYMOUNTS Control VIBRATION and IMPACT

We offer a complete line of highly engineered Vibration and Impact isolators for commercial, industrial, and military applications . . . also an engineering consulting service on special problems.

Send for **NEW CATALOG**

THE BARRY CORPORATION

Formerly L. N. BARRY CO., INC.
177 SIDNEY STREET
CAMBRIDGE, MASS.

Name

Company Title

Street

City State

structor clearly. The television camera scales demonstration models up or down to proper size for most effective training.

With television, usable portions of obsolete motion picture training film can be salvaged and brought up to date by combining with personal demonstrations. Students lose interest in films showing obsolete planes, for instance, yet basic prin-

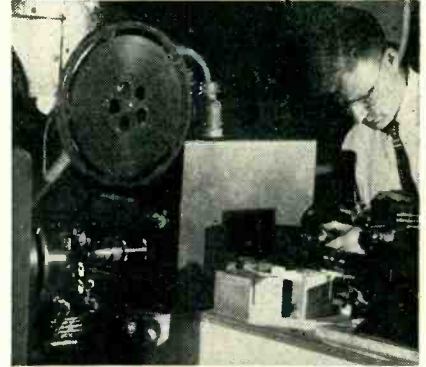

Two 35-mm slide-strip film projectors and a 16-mm sound film projector here feed into a GE film camera located under the control room of the Navy's television studio at Sands Point, Long Island. Two full-silvered front-surface mirrors make possible permanent mounting of all three sources, any of which can be cut into a studio program at will

ciples involved remain the same. Unparalleled flexibility in choice of instruction material is another advantage. The lecturer can change at will from models to artwork, maps, diagrams, motion pictures, film strips, slides, demonstration devices, training devices and actual service gear.

Though television offers promise of better instruction, it does not eliminate all instructors. Rather, it permits use of local laboratory instructors and assists them with the best of lecture help. It is not intended for teaching all subjects; introduction sessions to courses and the more difficult sessions offer greatest promise. Whether television will actually reduce learning time through use of new and more effective techniques is not yet known.

Radio Parts Show and RMA Silver Anniversary

PLANS HAVE BEEN made for a gala radio industry celebration in Chicago during the week of May 15, 1949, combining the RMA Silver

Silicone News



HUNDREDS OF AUTHORS

Thanks to the cooperative efforts of hundreds of scientists and engineers in almost every field of industry, we have been able to compile a comprehensive new booklet about DC 200 Fluids.

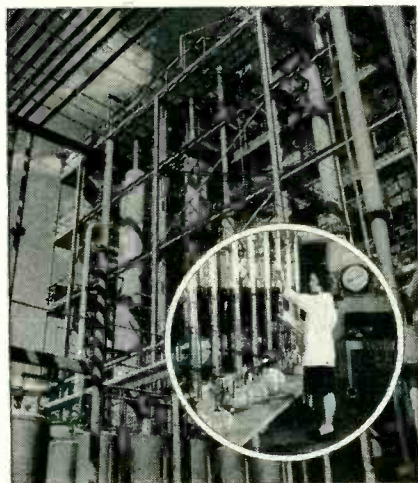

In early 1943 glass distillation columns supplied the demand for silicone products. By 1944, we had completed a multi-million dollar plant to supply war time requirements. During the past four years plant capacity has been tripled to supply the domestic and foreign markets.

We had been producing DC 200 Fluids for less than a year when we published a 4-page leaflet describing these remarkably stable silicone fluids. Our newest publication is a 32-page booklet describing some of the more typical applications and giving data on the more significant properties of the DC 200 Fluids.

This volume of information is evidence of a unique and useful combination of properties in the fluids themselves. It is proof of the ready acceptance given to these basically new materials by scientists, engineers and technicians in almost every industry. They have improved the performance of all sorts of devices by capitalizing on the properties of DC 200 Fluids. We, in turn, have gained knowledge and experience by giving technical assistance.

The benefits of our years of research and experience in producing DC 200 Fluids and in adapting them to many different applications are made available in booklet No. N-C-13. We hope that you will call on the technical representatives assigned to each of our branch offices for any additional information or assistance.

DOW CORNING CORPORATION MIDLAND, MICHIGAN

Atlanta • Chicago • Cleveland • Dallas
Los Angeles • New York

In Canada: Fiberglas Canada, Ltd., Toronto
In England: Albright and Wilson, Ltd., London



If you Manufacture...



AUTOMOBILES



TRUCKS AND BUSES



WASHERS



COMMUNICATION TRANSMITTERS



DISPENSERS

YOU CAN SAVE

3 Ways

WITH ESSEX "PACKAGED" WIRING HARNESS.....

1 Engineering 2 First Cost 3 Installation

Scores of users have found that they save time, trouble and money by turning their electrical wiring harness problems over to Essex specialists.

Essex *One-Source* service handles the intricate job of producing lighting, ignition and control harness assemblies *custom-built* to your exact specifications and *complete* with all

manual and electrical control devices for quick, efficient installation.

Through intensive specialization in wiring harness assemblies, Essex has developed line production methods of manufacturing, assembly and inspection, for economical production of high grade, individually tested, specially engineered assemblies.

INVESTIGATE ESSEX "ONE-SOURCE" SERVICE TODAY!



ESSEX WIRE CORPORATION

WIRE ASSEMBLY AND CORD SET DIVISION
SALES DEPARTMENT

MONTICELLO, INDIANA

Sales Offices: Chicago, Ill.; Cleveland, Ohio; Dayton, Ohio; Detroit, Mich.; Kansas City, Mo.; Los Angeles, Calif.; Milwaukee, Wis.; Newark, N. J.; Philadelphia, Pa.; San Francisco, Calif.; St. Louis, Mo.

CONTINENTAL

Leads Again

With SMALLEST End-On Lead Sulfide Tube Ever Put Into Steady Production

*LITTLE MINIATURE IN ELECTRONIC FIELD READY FOR BIGGEST JOBS

THE New Continental CE-703 End-on Lead Sulfide cell will revolutionize Electronic Equipment manufacture. It will have the instant approval of equipment designers who have long sought a practical sub-miniature cell in applications where banking of numerous cells in a small space is required. It will open up new fields in the designing of photoelectric equipment at a great saving on materials and space. It's of the photoconductive type with high voltage sensitivity and good response to infra-red radiation up to 3μ .

*Can be made as small as $\frac{3}{16}$ " dia. by $\frac{1}{2}$ " in length. Standard size $\frac{1}{4}$ " x $\frac{3}{4}$ ". Write for data on any larger sizes required.



CONTINENTAL ELECTRIC CO.

America's Leader in Quality Electronic Tube Manufacture
GENEVA, ILLINOIS

HARVEY HAS THE TOPS

FM TRANSLATOR
General Electric Model XFM-1



Post-war version of the old G.E. J.F.M-90 Translator which was used and enjoyed by tens of thousands of discriminating radio listeners.

Covers 88-108 mc range, dial 12 inches long, uses guillotine tuning for highest efficiency, high stability. Designed for export, has power inputs for 110 to 250 volts, 50/60 cy. Used in conjunction with good audio section or separate amplifier will provide best FM listening you ever heard. In attractive natural walnut cabinet — 10 3/4" high x 15 3/4" wide x 11 3/8" deep, complete with 8 tubes. Tropic-proof construction. Quantity limited.

Special Price \$49.50

TECHMASTER TV KIT



Exactly
The Same as the
RCA 630TS TV Chassis

Complete kit of parts, including pre-wired and aligned RCA front end, condensers, resistors, punched chassis, all tubes including kine, complete manual with service notes, all RCA **\$198.50**

LS-3 SPEAKER



Signal Corps model, 6" PM speaker, weather resistant, in rugged crackle finish steel case. Complete with self-contained

transformer to match 4000-ohm load. Voice coil impedance 6-8 ohms. Ideal for many uses.

Harvey Special **\$4.95**

All prices Net, F.O.B., N.Y.C.
Subject to Change Without Notice

Telephone: **1-800-368-2222** Longacre 3-1800

HARVEY RADIO COMPANY INC.
103 West 43rd St., New York 18, N. Y.

Anniversary convention and the annual Radio Parts Industry Trade Show. Events will be climaxed by a banquet on Thursday, May 19, at the Stevens Hotel.

The Parts Show management also decided to broaden the eligibility rule for exhibits by parts and components manufacturers to give limited exhibition privileges in the 1949 show to parts manufacturers selling to set manufacturers or other industrial outlets, in addition to manufacturers selling to jobbers, heretofore admitted.

IRE Fellowships

AT THE SEPTEMBER meeting of the IRE board of directors, the following members of the Institute were elected to the grade of Fellow:

H. A. Affel of Bell Telephone Laboratories, New York, N. Y.; K. C. Black of Aircraft Radio Corp., Boonton, N. J.; J. E. Brown of Zenith Radio Corp., Chicago, Ill.; Clelio Brunetti of National Bureau of Standards, Washington, D. C.; W. L. Carlson of RCA Laboratories, Princeton, N. J.; P. S. Carter of RCA Labs, Rocky Point, N. Y.; F. E. d'Humy of Western Union Telegraph Co., New York, N. Y.; John N. Dyer of Airborne Instruments Laboratory, Mineola, N. Y.; L. A. Gebhard of Naval Research Laboratory, Washington, D. C.; T. T. Goldsmith, Jr. of Allen B. DuMont Laboratories, Passaic, N. J.; F. W. Grover of Union College, Schenectady, N. Y.; E. A. Guillemin of MIT, Cambridge, Mass.; Ross Gunn of U. S. Weather Bureau, Washington, D. C.; A. V. Haeff of Naval Research Laboratory, Washington, D. C.; L. C. Holmes of Stromberg-Carlson Co., Rochester, N. Y.; J. Kelly Johnson, consulting engineer, New York, N. Y.; S. R. Kantebet of the Government of India Overseas Communication Service, Bombay, India; W. B. Lodge of Columbia Broadcasting System, New York, N. Y.; K. A. MacKinnon, consulting engineer, Ottawa, Ontario, Canada; H. F. Olson of RCA Laboratories, Princeton, N. J.; G. D. O'Neill of Pennsylvania Electric Products, Inc., Flushing, N. Y.; L. S. Payne of Canadian Marconi Co., Ltd., Montreal, Canada; L. M. Price of Radio Valve Co. of Canada, Toronto, Canada; H. J. Reich of Yale University, New Haven, Conn.; J. D. Reid of Crosley Division of Avco Mfg. Corp., Cincinnati, Ohio; Karl Spangenberg of Stanford University, Calif.; George Sterling of the FCC, Washington, D. C.; C. E. Strong of Standard Telephones and Cables, Ltd., New Southgate, London, England; Franz Tank, Institut fur Hochfrequenz Technik, Zurich, Switzerland; W. N. Tuttle of General Radio Co., Cambridge, Mass.; I. R. Weir of General Electric Co., Syracuse, N. Y.

It was also announced by the board that the Institute's Medal of Honor would be awarded to Ralph Bown, director of research at Bell Telephone Laboratories and member of the Joint Technical Advisory Committee of the RMA and IRE.

Midwest Television Networks

FIVE TELEVISION affiliates of NBC are now linked in a new midwestern coaxial cable network. Participating stations are WBEN-TV, Buffalo, N. Y., WSPD-TV, Toledo, O.;

Wires drawn to .0004" diameter.

WIRE & RIBBON MICRODIMENSIONAL FOR VACUUM TUBES

Ribbon rolled to .0001" thickness.

At oys for Special requirements.

WRITE or list of stock alloys.

SIGMUND COHN CORP.
43 GOLD ST., NEW YORK

SINCE 1871

Where SPACE and PERFORMANCE are Vital DUMONT OFFERS

The **TINYMITE**

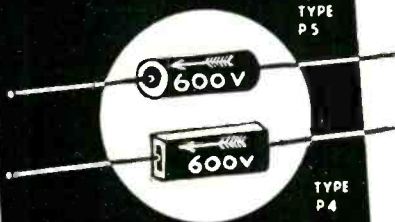

SMALLEST PAPER CAPACITOR yet 100% MOISTUREPROOF



AUTO RADIOS



CLOCK RADIO

Proof of the pudding is in the eating.

TINYMITES

are the largest selling miniature paper capacitors in the world.

- Good for 100°C
- Leads CANNOT pull out
- CAP. from .0001 to 2 MFD from 100 volts to 1000 volts.

Send for List and prices.



HEARING AIDS



CARRYING RADIOS

DUMONT ELECTRIC CORP.

MFR'S OF CAPACITORS FOR EVERY REQUIREMENT
308 DYCKMAN ST., NEW YORK, N. Y.



JULIUS KORANY

Leading authority on tube production and design, whose association with Arcturus dates back to the **QUICK HEATING BLUE TUBES** is in charge of our Tube Division.



Constant research and improvement in manufacturing techniques, under the supervision of Mr. Korany, have resulted in a line of tubes unsurpassed for dependability and high quality performance.

Write for the Arcturus Tube Data Chart

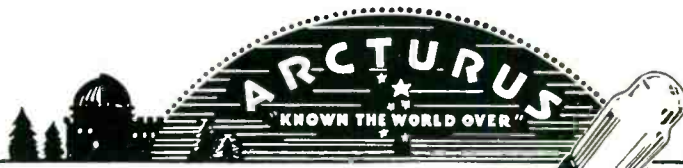

STANDARD ARCTURUS CORPORATION

54 CLARK STREET • NEWARK 4, NEW JERSEY HUmboldt 2-2400

Measure Frequencies

- **INSTANTLY** ... direct reading. No computation.
- **ACCURATELY** ... to a frequency determination of 0.05%.
- **VISUALLY** ... at the turn of the dial indicator knob.

Used effectively in leading laboratories, such as: Harvard University, Bell Aircraft Corp., and Hamilton Standard Propellers... for measuring natural frequencies or speed of rotating objects, checking or calibrating tachometers, oscillators, impulse generators, similar equipment.

C. G. CONN LTD., DEPT. 1112 ELKHART, IND.



Write for Free Folder



Please send free Strobocorr folder containing information about operation and application of this new precision instrument. I understand this places me under no obligation.

Name _____ Position _____
 Company _____
 Address _____
 City _____ Zone _____ State _____



WWJ-TV, Detroit, Mich.; WTMJ-TV, Milwaukee, Wis.; and KSD-TV, St. Louis, Mo.

The pioneer NBC group listed above will soon be expanded to other cities in the area, including WNBQ, Chicago and WNBK, Cleveland. It is expected that by January 1 the midwestern net will be linked with the NBC television network now spanning the eastern seaboard.

Also in operation for telecasting of presidential election returns are ABC's six-station midwestern television network, comprising KSO-

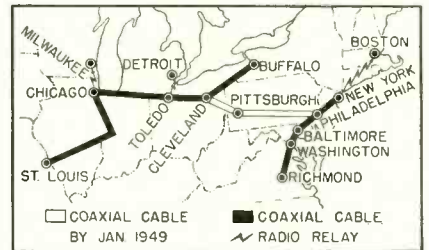

TV in St. Louis, WTMJ-TV in Milwaukee, WSPD-TV in Toledo, WXYZ-TV in Detroit, WEWS in Cleveland and WBEN-TV in Buffalo. As this lineup indicates, midwestern television stations are in some instances joining two networks.

National Electronics Conference Program

Two outstanding features of the 1948 National Electronics Conference at the Edgewater Beach Hotel, Chicago, November 4, 5, and 6, will be the banquet in the Marine Dining Room on Thursday evening, November 4, and a large-screen television demonstration by RCA in the Crystal Ballroom on Friday at 8:00 p.m.

The technical program is as follows:

Thursday, November 4

- 9:00 a.m.—Registration, Edgewater Beach Hotel, Chicago
- 10:00 a.m.—Session 1: NEW MATERIALS
 - Properties of CbN at Radio Frequencies, by J. V. Lebacqz and Donald H. Andrews of Johns Hopkins University.
 - Development and Properties of Some Ceramic Dielectrics, by G. R. Shelton, E. N. Bunting and A. S. Creamer of National Bureau of Standards.
 - The Transistor—Its Properties and Characteristics, by Walter H. Brattain of Bell Labs.
- 10:00 a.m.—Session 2: SOUND MEASUREMENT—RECORDING
 - Application of Miniature-Circuit Techniques to the Sound Level Meter, by H. H. Scott of Hermon Hosmer Scott, Inc.
 - An Evaluation of the Application of New and Old Techniques to the Improvement of Magnetic Recording Systems, by



Precision
Rod Cutting
at High Speed

with the New
DI-ACRO ROD PARTER

This newest member of the DI-ACRO "DIE-LESS DUPLICATING" family of Machines brings you accuracy, speed, capacity range and ease of operation fully up to the standards of DI-ACRO Benders, Brakes, Shears.

Do you require precision?—The DI-ACRO Rod Parter holds tolerance to .001" on duplicated cuts. The ends are square, and roundness is maintained.

Do you want speed?—The Rod Parter exceeds output of other methods with equal accuracy, on rods and bars up to 5/8". Torrington Roller Bearings incorporated in an exclusive multiple leverage arrangement provide remarkable ease of operation in both heavy and light materials.

GET "DIE-LESS DUPLICATING" CATALOG

Shows parts produced without die expense by DI-ACRO Benders, Brakes, Shears, Rod Parters, Notchers, Punches. Send for your free copy.

Pronounced "DIE-ACK-RO"

"PARTS OFF" MANY MATERIALS

- All hot and cold rolled rods
- Stainless steel
- Chrome Molybdenum
- Aluminum Brass
- Copper Bi-metals
- Many types of plastics
- Fibre Rubber
- Wood



O'NEIL-IRWIN MFG. CO.

321 EIGHTH AVENUE • LAKE CITY, MINNESOTA



ADVANCE — AMPHENOL — AEROVOX — ASTATIC
ALTEC-LANSING BRUSH
B & W-BUD BLILEY
BIRN BACH BROWNING
BURGESS CARDWELL-DRAKE
CENTRALAB — CIN AUDAGRAPH — CORNELL — DUBLIER
EIMAC — ELECTROVOICE — GE — JFD — IRC — JENSEN
MALLORY — LITTLEFUSE — MEISSNER — MILLEN
MILLER — NATIONAL — OHMITE — RCA — SANGAMO
SHURE — UTAH — STEVENS — STANCOR — WELLER
UNIVERSITY — SYLVANIA — THORDARSON — WEBSTER
PICKERING — ICA — PRECISION — UNITED ELECT.

ALL FOR YOUR CONVENIENCE

CALL JACK KIRSCHBAUM AT DIGBY 9-4714

ARROW ELECTRONICS

INCORPORATED
82 CORTLANDT STREET, NEW YORK 7, N.Y.

MANUFACTURERS:

QUICKER!

MORE ACCURATE!

TELEVISION SET

Alignment & Adjustment

TIC PRECISION GENERATORS

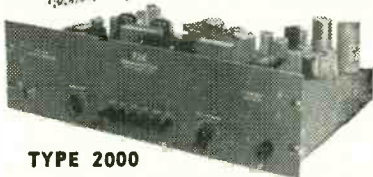

TYPE 2000

BAR & DOT GENERATOR

A precise means for adjusting horizontal and vertical sweep linearity of television receivers when used in conjunction with Standard Synchronizing Signal and Monoscope Generator or other pattern or picture signal generator. Requires only 5 1/4" of standard rack space. Five convenient push-buttons allow instantaneous selection of: • Standard blanking • Vertical bars only • Horizontal bars only • Vertical and horizontal bars • Complete dot pattern. Has phasing control for adjustment of vertical bar position. Self contained regulated power supply.

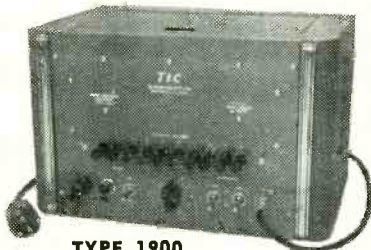

TYPE 1900

CRYSTAL CONTROLLED MULTI-FREQUENCY GENERATOR

A 10 frequency, 400 cps modulated crystal controlled oscillator, ideal for production line adjustment of stagger tuned I.F. amplifiers in television sets. Available with crystals ranging from 4.5 to 40 mc. provided to exact frequency and in sequence specified by customer. Each frequency is immediately selectable by means of a push button. Output attenuator range 5 V to 500 microvolts. Self contained regulated power supply.

Write for bulletins 2000 & 1900

TEL Instrument Co. Inc.
50 PATERSON AVE.
East Rutherford, New Jersey
Rutherford 2-9720

SLICE Rising Time Costs with Solder Pre-Forms

Eliminate time-consuming manual solder operations in your assembly processes. Pre-formed rings, washers, discs, pellets, squares, etc., complete with flux, save time, trim labor costs, insure cleaner, more uniform, sturdier bonds. We meet your specifications in the widest variety of solder alloys. Consult with us on any solder or brazing problem.

(Literature on Request).

Soldering Specialties

Dept. C, Summit, N. J.

Are you getting ALL the advantages that PAPER offers?

Central Engineered Electrical Papers are among the most versatile of materials. They can be accurately controlled in thickness, porosity, Ph, weight and many other characteristics. Central Electrical Papers can also be made with anti-rust and anti-tarnish properties . . . they can be creped for easier wrapping around corners . . . they can be juted for extra strength . . . they can be water-proofed . . . or almost any combination of these properties and special treatments may be had. Thus with Central Engineered Electrical Papers you can have many combinations of physical and electrical properties to suit exactly your particular design.

The Central Paper Engineer knows his papers and is backed by laboratory facilities second to none in the industry. Discuss your design problems with him.

He can offer many helpful suggestions on how paper can help you produce better products at lower cost. His services are yours for the asking.



**THIS
FREE
BOOK**

contains data on Electrical Paper Properties
and a wide variety of samples. Write for your copy today.

CENTRAL PAPER COMPANY, INC.

2442 Lakeshore Drive Muskegon, Mich.



REG. U. S.
PAT. OFF.

BRADLEY RECTIFIERS

HIGH VOLTAGE SELENIUM RECTIFIERS



Hermetically sealed in 1/2" diameter glass tubes, Bradley SE6M high voltage selenium rectifiers are rated up to 5 ma. D.C. They are polarized for fuse clip-type mounting. Available from 1,000 to 15,000 volts peak inverse. Bradley engineers can quickly specify the right type of selenium or copper oxide rectifier for your need.

PHOTO CELLS

SIMPLIFY PHOTO CELL CONTROL



Luxtron* photo cells convert light into electrical energy. No external voltage is required to operate meters and meter relays directly from Bradley photo cells, improving control over your processes, reducing your costs. Housed model shown. Many different sizes and shapes, mounted and unmounted.

* T. M. REG. U. S. PAT. OFF.

Our engineers will select or develop rectifiers or photo cells to meet your needs exactly. Write for BRADLEY LINE showing basic models.

BRADLEY
LABORATORIES, INC.
82 Meadow St. New Haven 10, Conn.

Lynn C. Holmes of Stromberg-Carlson Co. Magnetic Records for Home Entertainment, by Marvin Camras of Armour Research Foundation.

10:00 a.m.—Session 3: SERVOMECHANISMS

Electronic Circuits for Control of Clutch Type Servomechanisms, by F. E. Edwards, Jr. of Buehler and Co.

Signal Generators for Servo System Measurements, by Charles F. White of Naval Research Laboratory.

Evaluating Servomechanisms Performance, by George M. Attura of Servomechanisms, Inc.

12:15 p.m.—Luncheon Meeting; Science, Industry and the Future of Man, by Anton J. Carlson of Univ. of Chicago.

2:00 p.m.—Session 4: COMMUNICATIONS

Corona Interference with Radio Reception in Aircraft, by M. M. Newman of Lightning and Transients Research Institute.

The Effect of Air Speed Upon Precipitation Charging of an Airplane, by Homer J. Dana of Washington State College.

Extraction of Weak Signals from Noise by Integration, by Harry Stockman of Cambridge Field Station, Watson Labs., Cambridge, Mass.

Optimum Selectivity in Superregenerators, by Donald Richman of Hazeltine.

Terminal Equipment for Pulse-Time Multiplex, by A. M. Levine and D. D. Grieg of Federal Telecommunication Laboratories, Inc.

2:00 p.m.—Session 5: ELECTRONIC INSTRUMENTATION—I

A Square-Law Power-Level Recorder, by W. R. Clark and A. J. Williams, Jr. of Leeds and Northrup, and W. R. Turner of Naval Ordnance Laboratory.

The Development of a High-Speed Recording Anemometer, by John M. Cage of Purdue Univ.

A Precision Electronic pH Control, by J. E. Breeze of National Research Council, Canada.

Electronic Methods for Measurement of Pressure and Displacement, by A. Crossley and D. L. Elam of Electro Products Laboratories, Inc., Chicago, Ill.

Application of a D-C Negative Feedback Amplifier to Compensate for the Thermal Lag of a Hot-wire Anemometer, by Philip G. Hubbard of State Univ. of Iowa.

2:00 p.m.—Session 6: NEW TUBE DEVELOPMENTS

Alkali-Metal Alloys for Cathodes of Power Electronic Tubes, by J. A. M. Lyon of Northwestern Univ. and C. E. Williams of Standard Oil Co. of Whiting, Ind.

Mass Production Techniques for Television Kinescopes, by D. Y. Smith of RCA, Camden, N. J.

The Surge Testing of High Vacuum Tubes, by H. J. Dailey of Westinghouse.

A New Subminiature Electrometer Tube, by H. F. Starke of Raytheon.

Design Considerations for Dual Control Grid Pentode, by Roger W. Slinkman of Pennsylvania.

7:00 p.m.—Banquet; Marine Dining Room; Edgewater Beach Floor Show and Dancing.

Friday, November 5

9:00 a.m.—Session 7: MICROWAVES

The Dynatron Tube as a Very High-Frequency Oscillator, by R. A. Dehn of GE.

A New Type of Slotted Line Section, by W. Bruce Wholey and W. Noel Eldred of Hewlett-Packard Co.

Microwave Slotted Sections, by Stanley A. Johnson of Polytechnic Research and Development Co.

Tunable Waveguide Cavity Resonators for Broadband Operation of Reflex Klystrons, by W. W. Harman of Stanford Univ.

A Periodic Waveguide Travelling Wave Amplifier for Medium Powers at Microwaves, by G. C. Dewey of Federal Telecommunication Laboratories.

9:00 a.m.—Session 8: ANALYSIS AIDS-COMPUTERS

Root-Solver for Tenth Degree Algebraic Equations, by G. H. Singer, Jr., and J. F. Calvert of Northwestern Univ.

Analysis of Rototrol Voltage Regulators by Electrical Analogy, by James T. Carleton of Westinghouse.

A Polar Vector Indicator, by A. H. Waynick, P. G. Sulzer, and E. A. Walker of Pennsylvania State College.

Automatic Number Storage System, by T. Kite Sharpless of Technitrol Engineering Company, Inc.

Design and Operation of the IBM Selective Sequence Electronic Calculator, by Robert Rex Seeber, Jr. of International Business Machines Corp.

SAVE

- MATERIALS
- MAN-HOURS
- MONEY

with the . . .



Select exactly the right semi-tubular, split rivet, or cold-headed fastener from Milford's complete line. You'll find it pays in every way!



Then use the right rivet setting machine for your application. One of Milford's 15 basic machines is sure to solve your particular problem . . . and slash your production costs!

PENN RIVET & MACHINE COMPANY
254 Huntingdon Street
PHILADELPHIA 33, PENN.



Linde

ARGON
HELIUM
KRYPTON
NEON
XENON

and Standard or Special
MIXTURES

LINDE rare gases are spectroscopically pure—argon, helium, neon, and standard mixtures are available in one- and two-liter glass bulbs and in cylinders; xenon and krypton are available in liter and fractional-liter bulbs.

The word "Linde" is a trade-mark of

THE LINDE AIR PRODUCTS COMPANY
Unit of Union Carbide and Carbon Corporation
30 East 42nd St.  New York 17, N. Y.

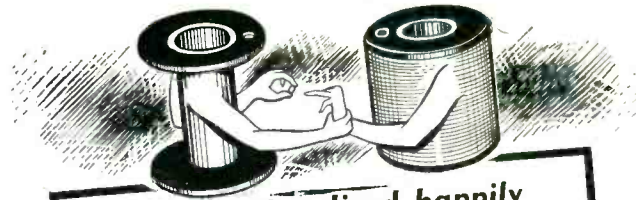

"—And they lived happily ever after."
Your coil windings are perfectly mated for long and useful life when the bases are

PRECISION BOBBINS

Precision provides the strength, the insulation, the dependability by the most thorough specialized engineering, exactly to your specifications.

Spiral winding of the tube—heavy heat-treated compression—swaged tube ends securely locked—impregnation of the complete assembly are factors of Precision's exceptional service. Lightest of all coil bases. Permit larger gauge, or more wire of same gauge in winding area.

Let us make up samples for your requirements

Also mfrs. of dielectric tubes, round, square, rectangular, any length, ID or OD; coil forms; spools; dust caps and thread protectors.



PRECISION PAPER TUBE CO.

2041 W. CHARLESTON ST.
Plant No. 2 at 79 Chapel St.

CHICAGO 47, ILL.
Hartford, Conn.

Do you need a
DRY BATTERY
you can't find?



There is a
**SPECIALTY
DRY
BATTERY**

for your special need

If you are looking for hard-to-get or special dry batteries, write us. We design, create and manufacture to your requirements.

Send for this
FREE
Catalog



SPECIALTY BATTERY COMPANY

A SUBSIDIARY
OF THE

RAY-O-VAC

RAY-O-VAC
COMPANY

MADISON 4, WISCONSIN

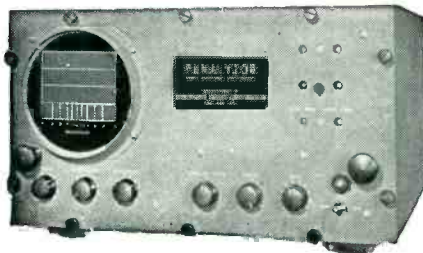

Designed for
**YOUR APPLICATION
PANADAPTOR**

Whether your application of spectrum analysis requires high resolution of signals closely adjacent in frequency or extra broad spectrum scanning, there is a standard model Panadaptor to simplify and speed up your job. Standardized input frequencies enable operation with most receivers.

	MODEL SA-3 TYPES						MODEL SA-6 TYPES		
	T-50	T-100	T-200	T-1000	T-1000	T-6000	T-1000	T-10000	T-20000
Maximum Scanning Width	50KC	100KC	200KC	1MC	1MC	6MC	1MC	10MC	20MC
Input Center Frequency	455KC	455KC	455KC	5.25MC	10.2MC	30MC	5.25MC	30MC	30MC
Resolution at Maximum Scanning Width	2.5KC	3.4KC	4.4KC	11KC	11KC	25KC	11KC	75KC	91KC
Resolution at 20% of Maximum Scanning Width	1.9KC	2.7KC	4KC	9KC	7.5KC	22KC	7.5KC	65KC	75KC

Investigate these
APPLICATIONS OF PANADAPTOR

- *Frequency Monitoring
- *Oscillator performance analysis
- *FM and AM studies

WRITE NOW for recommendations, detailed specifications, prices and delivery time.

PANORAMIC RADIO CORP.



92 Gold St.
New York 7, N. Y.
Cable Address
PANORAMIC, NEW YORK
Exclusive Canadian Representative: Canadian Marconi, Ltd.

TWIN Power Supply

**Electronically
Regulated for
Precise
Measurements**

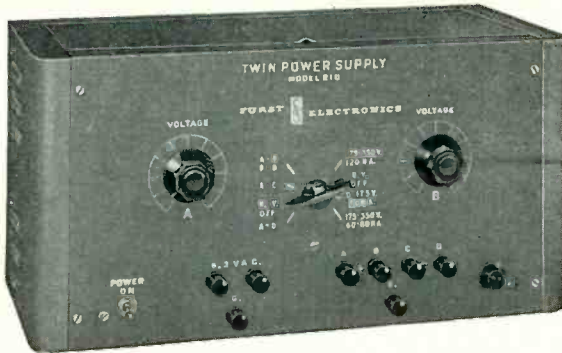

Two independent sources of continuously variable D.C. are combined in this one convenient unit. Its double utility makes it a most useful instrument for laboratory and test station work. Three power ranges are instantly selected with a rotary switch:

- 175-350 V. at 0-60 Ma., terminated and controlled independently, may be used to supply 2 separate requirements.
- 0-175 V. at 0-60 Ma. for single supply.
- 175-350 V. at 0-120 Ma. for single supply.

In addition, a convenient 6.3 V.A.C. filament source is provided. The normally floating system is properly terminated for external grounding when desired. Adequately protected against overloads.

- **Output voltage variation less than 1% with change from 0 to full load.**
- **Output voltage variation less than 1 V. with change from 105 to 125 A.C. Line Voltage.**
- **Output ripple and noise less than .010.**

Twin Power Supply Model 210
Complete \$130.00

Dimensions: 16" x 8" x 8" Shipping Wt. 35 lbs.
(Other types for your special requirement)

Visit Our Booth No. 17 at the National Electronics Conference



FURST ELECTRONICS

806 W. North Ave., Chicago 22, Illinois

Automatic Frequency Control

**on DC to AC
CONVERTERS**

AVAILABLE IN 22 TYPES
AND 3 FRAME SIZES BY

Gothard

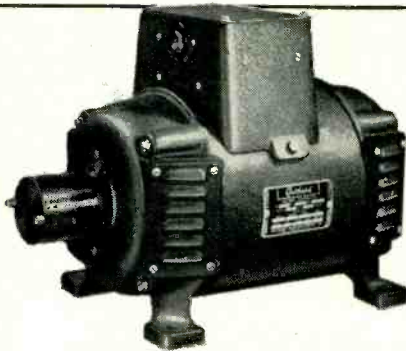

DC to AC Rotary Converters having Automatic Frequency Control are now being offered in all models. Input voltages from 6 to 230 V DC; output: 110 to 1000 VA at 60 cycles, 90 to 800 VA at 50 cycles.

SPECIALLY DESIGNED for Television Sets, AC Radios, Radio-Phonographs and Recorders. For use where the power source is direct current: such as ships, vehicles, trains, office buildings, and urban DC areas.

Write today for
illustrated cata-
log #48 on:
DYNAMOTORS
CONVERTERS
GENERATORS

GOTHARD Manufacturing Co.

2114 Clear Lake Ave.

Springfield, Illinois

Export Division: 25 Warren St., New York 7, N. Y.

NEWS OF THE INDUSTRY

(continued)

9:00 a.m.—Session 9: INDUSTRIAL APPLICATIONS

Precision Photoelectric Control of High-Temperature Furnaces, by F. C. Todd of Battelle Memorial Institute, Columbus, Ohio.

The Application of Radar Techniques to a System for High Speed X-Ray Movies, by D. Dickson, C. Zavales and L. F. Ehrke of Westinghouse.

CRT Applications in Photography and Optics, by Carl Berkley and Rudolf Feldt of DuMont.

A 500-50,000 Volt Regulated Power Supply, by Roy E. Anderson of GE.

12:15 p.m.—Luncheon Meeting; The Decline and Fall of the Free Electron, by Donald G. Fink, Editor-in-chief, ELECTRONICS.

2:00 p.m.—Session 10: TELEVISION

The Locked Oscillator in Television Reception, by Kurt Schlesinger of Motorola.

Master Television Antenna and Signal Distribution Systems for Large Buildings, by R. D. Duncan, Jr., of RCA.

Development of a Large Metal Kinescope for Television, by J. Kelar, H. P. Steier, C. T. Lattimer, and R. D. Faulkner of RCA.

Large Screen Television, by R. V. Little, Jr. of RCA, with demonstration.

2:00 p.m.—Session 11: MANAGEMENT OF RESEARCH

Organization of Research, by C. C. Furnas of Cornell Aeronautical Laboratory.

Development of Physical Facilities for Research, by R. B. Dittmar of Los Alamos Scientific Laboratory.

Personnel Administration in Research and Development Organizations, by C. E. Barthel, Jr., of Armour Research Foundation.

Information Exchange as a Management Tool in a Large Research Organization, by Allen H. Schooley of Naval Research Laboratory.

Research Ideas Go to Market, by Waldo H. Kllever of Minneapolis-Honeywell Regulator Co.

2:00 p.m.—Session 12: ELECTRONIC CIRCUITS

Response of an Amplifier to a Signal Varying Linearly in Frequency, by W. H. Hamilton of Westinghouse.

An Extremely Wide Range Electronically Adjustable Oscillator, by Millard E. Ames of Philco.

An Improved Regenerative Frequency Standard Application, by F. E. Wyman of Naval Research Laboratory.

Design of a Wide-Band Frequency Discriminator Circuit, by Vincent C. Rideout of Univ. of Wisconsin.

Circuit Design for Reduction of Hum, by Arthur F. Dickerson of GE.

8:00 p.m.—Demonstration — Ballroom; Large Screen Television, by R. V. Little, Jr. of RCA; repeat performance for those unable to attend earlier demonstration.

Saturday, November 6

9:00 a.m.—Session 13: MAGNETIC AMPLIFIERS

An Analysis of Magnetic Amplifiers with Feedback, by D. W. VerPlanck and M. Fishman of Carnegie Institute of Technology.

Influence of Core Material on Magnetic Amplifier Design, by A. O. Black, Jr. of U. S. Naval Ordnance Laboratory.

An Analysis of Interlinked Electric and Magnetic Networks with Application to Magnetic Amplifiers, by D. W. VerPlanck and M. Fishman of Carnegie Institute of Technology.

9:00 a.m.—Session 14: ELECTRONIC INSTRUMENTATION—II

An Electronic Power Factor Meter, by E. B. Kurtz and Paul O. Erickson of State Univ. of Iowa.

Cathode-ray Oscilloscope with 100-Megacycle Bandwidth, by M. M. Newman of Lightning and Transients Research Institute and P. S. Christaldi and R. P. Featherstone of DuMont.

Absolute Accuracy—Primary Frequency Standard, by Harry R. Meahl of GE.

Low-Distortion A-M Signal Generator, by E. S. Sampson of GE.

An Electron Tube for Viewing Magnetic Fields, by S. G. Lutz and S. J. Tetenbaum of New York Univ.

9:00 a.m.—Session 15: ANTENNAS

Radio Direction Finding System Analyzer, by E. C. Jordan and J. J. Myers of Univ. of Illinois.

Open-ended Waveguide Radiators, by

Do you need
a delay period
in an
Electrical
Circuit?



Investigate the
**EDISON MODEL 501
THERMAL RELAY**

The Edison Model 501 Thermal Relay solves many circuit problems, such as timing, over- and under-voltage or current protection, cathode protection, motor starting, integration and "holdovers."

DELAY INTERVAL:
5 seconds to 8 minutes, factory preset.

CONTACT RATING:
6 amp. at 250 volts AC or DC, normally.

HEATER INPUT:
5 watts nominal, continuous excitation, up to 115 volts AC or DC.

CONTACTS:
SPST, normally open or normally closed.

AMBIENT RANGE COMPENSATION:
-60° C (-76° F) to +60° C (+140° F).

DIMENSIONS:
1 1/4" diameter x 3 1/2" height, seated.

WEIGHT:
0.08 lb. to 0.14 lb.

MOUNTING:
Standard octal or 4-prong tube base.

Write for Publication No. 3007

204 Lakeside Avenue • West Orange, New Jersey



INSTRUMENT DIVISION
THOMAS A. EDISON, Incorporated

Flexible Shafts



Wherever power drives or remote control are required, you can depend upon us to produce the Flexible Shafts that will meet the exact specifications. We have years of experience in manufacturing flexible shafting for all types of industry. If we do not have what you require in stock, we can make shafts to your specifications. Our engineers will be glad to work out your problems without obligation.

Write for Manual D



F. W. STEWART MFG. CORP.
4311-13 RAVENSWOOD AVE.
CHICAGO 13, ILL.
WEST COAST BRANCH:
431 VENICE BLVD. LOS ANGELES 15, CAL.

PRECISION POTENTIOMETERS

Toroidal and Sinusoidal

For use in computing and analyzing devices; generation of low frequency saw tooth and sine waves; controls for radio and radar equipment; position indicators; servo-mechanisms; electro medical instruments, measuring devices—telemetry; gun fire control where 360° rotation, high precision and low noise levels are essential.

The type RL14MS sinusoidal potentiometer is illustrated. It is wound to a total resistance of 35,400 ohms and provides two voltages proportional to the sine and cosine of the shaft angle. It will generate a sine wave true within ±.6%. Overall dimensions are 4 3/8" diameter x 4 11/32" long plus shaft extension 1/4" diameter x 1 1/4" long.



Write for Bulletin F-68

THE GAMEWELL COMPANY

Newton Upper Falls 64, Massachusetts



PYRO-FERRIC IRON CORES

Since 1933 PYROFERRIC has been the standard source for IRON CORES manufactured to desired permeability, frequency, "Q", resistance and physical strength to fit any circuit.

PYROFERRIC, with its background of research and experience, will gladly consult with you on your IRON CORE requirements.

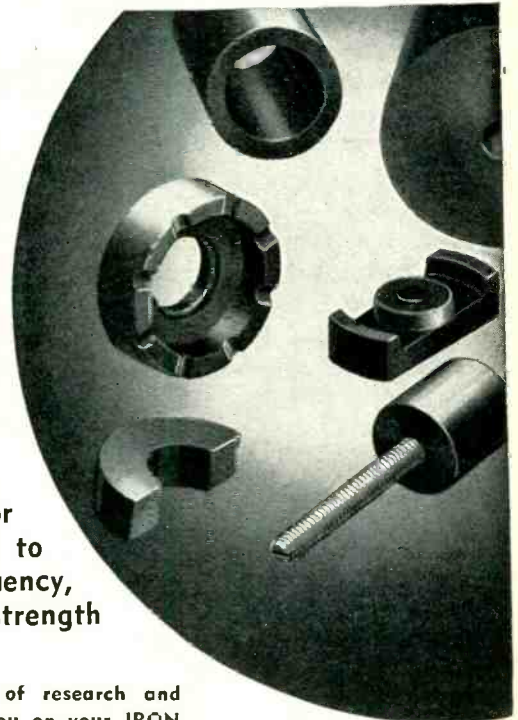

PYROFERRIC Co.
621 EAST 216 ST. NEW YORK 67, N. Y.

A NEW V-O-M "MODEL 500"



SENSITIVITY
20000 ohms/volt AC-DC

RANGES
AC-DC Volts: 0-3/15/150/300/750/
1500/7500

DC Current: 0-150 UA/1.5 MA/30
MA/1.5 A/15 A

OHMS: 0-5000/50,000/50,000,000
DB: -10/0/ + 73 in 7 ranges

FEATURES:

Highest sensitivity—Damped movement—Accurate—Rugged—Portable—Long mirrored scale—with added center zero range. Complete with High Voltage test leads. Housed in handsome hard-wood case.

Measure from a low of 10 microamperes to a high of 15 amperes—from .2 volts to 7500 volts—from 1 ohm to 50 million—from minus 10 to plus 73 DB.

So accurate it is used in the Laboratory. So rugged it withstands portable field use. Write for Catalog 4423 or see your jobber.

ROLLER-SMITH

BETHLEHEM, PA.



Electrical Indicating Instruments . Aircraft Instruments .
Switchgear . Air & Oil Circuit Breakers . Rotary Switches .
Relays . Precision Balances

NEWS OF THE INDUSTRY

(continued)

R. E. Beam, M. M. Astrahan and H. F. Mathis of Northwestern Univ. Measurement of Phase of Radiation Around Antennas, by John N. Hines and Charles H. Boehnker of Ohio State Univ. Research Foundation.

The Measurement of Antenna Impedance Using a Receiving Antenna, by Donald G. Wilson of Univ. of Kansas.

A High-Gain Cloverleaf Antenna, by P. H. Smith of Bell Labs.

BUSINESS NEWS

SYLVANIA ELECTRIC PRODUCTS, INC., Emporium, Pa., doubles its television tube output rate with the establishment of a new plant at Ottawa, Ohio.

ARTHUR ANSLEY MFG. Co., Doylestown, Pa., was recently organized for the production of high-fidelity sound reproducing equipment.

A. C. MONTEITH has been elected vice-president in charge of engineering and research at Westinghouse Electric Corp. after 25 years with the organization. He holds the company's Order of Merit, highest employee award for distinguished service and accomplishment.

MOTOROLA INC., Chicago, Ill., manufacturers of radio and television sets, recently purchased the Car Radio division of the International Detrola Corp., Detroit, Mich., and can now supply auto radios directly to automobile manufacturers.

SUBMARINE SIGNAL Co., subsidiary of Raytheon Mfg. Co., has purchased the building at 148 California St., Newton, Mass., to integrate operations with the parent company.

NATIONAL ELECTRONICS, INC., industrial tube manufacturer, recently added a 5,000-sq-ft factory building to its plant in Geneva, Illinois.

BROWN INSTRUMENT Co., a division of Minneapolis-Honeywell Regulator Co., hired 40 newly graduated engineers as one part of its \$2,500,000 physical expansion program.

AIRBORNE INSTRUMENTS LABORATORY, INC., Mineola, N. Y., has es-

A WORKSHOP HIGH-GAIN ANTENNA

will . . .

More than triple the effective power of the transmitter.

Increase the effective power of the mobile transmitter.

Increase the operating area.

Permit the use of low power, low cost equipment.

Workshop High-Gain Beacon Antennas are designed specifically for the 152-162 megacycle band—taxicab, fire, police, and private fleet communications.

Design Features

- Low angle of radiation concentrates energy on the horizon.
- Symmetrical design makes azimuth pattern circular.
- Can be fed with various types of transmission lines. Special fittings are available for special applications.
- Enclosed in non-metallic housing for maximum weather protection.

Available for immediate delivery through authorized distributors or your equipment manufacturer.

—THE— WORKSHOP ASSOCIATES

INCORPORATED

PAT. APP. FOR

Specialists in High-Frequency Antennas

64 NEEDHAM STREET
Newton Highlands 61, Mass.



NEW Subscription Order

Please enter my new subscription for **THREE YEARS** of **ELECTRONICS** for \$12.

(If you prefer 1 year of **ELECTRONICS** for \$6 check here)

Name:..... Position.....

Home Address:.....

City:..... Zone..... State.....

Company Name:.....

Foreign Rates (1 year) Canada \$7, Latin America \$10, Other \$15

11-48

NEW Subscription Order

Please enter my new subscription for **THREE YEARS** of **ELECTRONICS** for \$12.

(If you prefer 1 year of **ELECTRONICS** for \$6 check here)

Name:..... Position.....

Home Address:.....

City:..... Zone..... State.....

Company Name:.....

Foreign Rates (1 year) Canada \$7, Latin America \$10, Other \$15

11-48

Postage
Will be Paid
by
McGraw-Hill
Pub. Co.

No
Postage Stamp
Necessary
if Mailed in the
United States

BUSINESS REPLY CARD

First Class Permit No. 64 (Sec. 510, P. L. & R.) New York, N. Y.

4¢ POSTAGE WILL BE PAID BY —

McGRAW-HILL PUBLISHING CO., Inc.

ELECTRONICS

330 WEST 42nd STREET

NEW YORK 18, N. Y.



Postage
Will be Paid
by
McGraw-Hill
Pub. Co.

No
Postage Stamp
Necessary
if Mailed in the
United States

BUSINESS REPLY CARD

First Class Permit No. 64 (Sec. 510, P. L. & R.) New York, N. Y.

4¢ POSTAGE WILL BE PAID BY —

McGRAW-HILL PUBLISHING CO., Inc.

ELECTRONICS

330 WEST 42nd STREET

NEW YORK 18, N. Y.



**EISLER
ELECTRICAL & ELECTRONIC
EQUIPMENT
ELECTRONIC TUBE EQUIPMENT**



**36 HEAD
RADIO TUBE
EXHAUSTING
MACHINE**

We Make Complete Equipment For The Manufacture Of Incandescent Lamps Radio and Electronic Tubes.

TRANSFORMERS OF ALL TYPES

For **LIGHTING POWER FURNACES PHASE CHANGING DISTRIBUTION ETC.**

Air, Oil, or Water Cooled

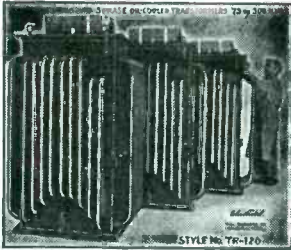

**SIZES 1/4 to 250 KVA
SPOT WELDERS**
OF ALL TYPES
FOR ALL PURPOSES
SIZES 1/4 to 250 KVA
Butt Welders - Gun Welders
Arc Welders
Neon Sign Units
Fluorescent Tube
Manufacturing Equipment

CHAS. EISLER

EISLER ENGINEERING CO., INC.
751 So. 13th St. (Near Avon Ave.), Newark 3, N. J.

Lavite **STEATITE
CERAMIC**



Design engineers and manufacturers in the radio, electrical and electronic fields are finding in LAVITE the precise qualities called for in their specifications . . . high compressive and dielectric strength, low moisture absorption and resistance to rot, fumes, acids, and high heat. The exceedingly low loss-factor of LAVITE plus its excellent workability makes it ideal for all high frequency applications.

Complete details on request

D. M. STEWARD MFG. COMPANY

Main Office & Works: Chattanooga, Tenn.
Needham, Mass. • Chicago • Los Angeles
New York • Philadelphia

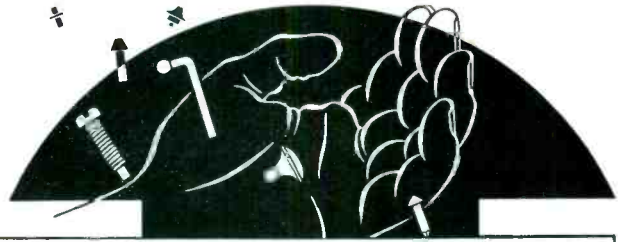

special nails • rivets • screws • made to your order

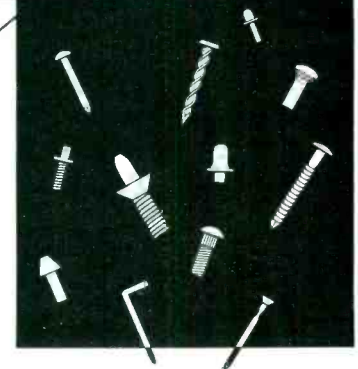

HASSALL cold-heading may solve your immediate special part problem . . . Special nails, rivets and threaded parts made in diameters from 1/32" to 3/8"—lengths up to 7" . . . Rivets 3/32" diameter and smaller a specialty . . . Variety of metals, finishes and secondary operations . . . Economy, quality and quick delivery in large or small quantities . . . Tell us what you need . . . We will answer promptly. ASK FOR FREE CATALOG. 3-color

Decimal Equivalents Wall Chart free on request.

JOHN HASSALL, INC. 150 Clay Street
Brooklyn 22, N.Y.

Manufacturers of Cold-Headed Specialties—Established 1850

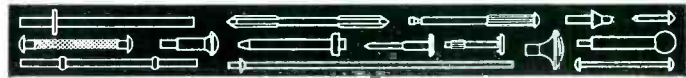

Here's Your **Sample Book**
of **RED STREAK**
electrical tapes

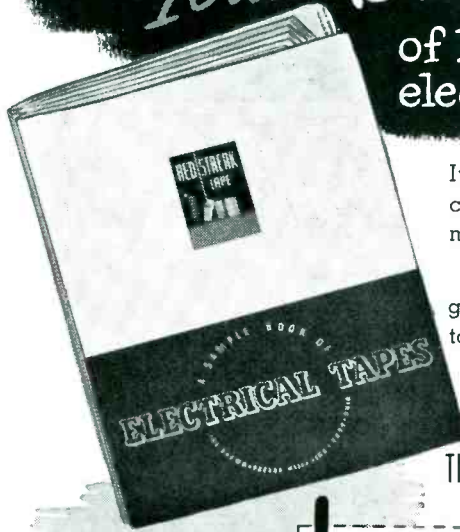

It's a valuable reference when considering materials used in the making of electronic parts.

Red Streak Acid-Free tapes and gummed flat sheets are made to critical specifications in a practical variety of materials of uniform thicknesses. The samples will tell you more.

The Brown-Bridge Mills, Inc., Troy, Ohio

Send coupon **TODAY** for
Your Copy
No obligation, of course.

The Brown-Bridge Mills, Inc., Dept. E 11-8, Troy, Ohio
Please send me the file folder size Sample Book of Red Streak Electrical Tapes.

NAME _____
FIRM _____
ADDRESS _____

Fairchild Precision Potentiometers



**long life
sustained accuracy
low noise level
absolute resolution
resetability
multiple ganging**

For further information address: Dept. 'K',
88-06 Van Wyck Boulevard, Jamaica 1, New York



established fellowships at Stanford University and MIT to help young men obtain advanced degrees in the field of communications and electronics.

RADIO CORP. OF AMERICA, Camden, N. J., recently held a four-day television seminar for 40 consulting engineers.

FEDERAL TELEPHONE AND RADIO CORP., Clifton, N. J., has installed a modernized f-m two-way radio system in place of the former a-m equipment in 215 mobile units on



One of five fireboats operated by the Baltimore Fire Department. It is equipped with Federal's 2-way f-m mobile radiotelephone

land and water, for police and fire department operations in Baltimore, Md. The units will operate in the 152 to 162-mc band. Change-over took place without interrupting the city's 24-hour service.

PERSONNEL

GEORGE C. KUCZYNSKI, attached to the staff of Sylvania Electric Metallurgical Laboratory, Bayside, N. Y., for basic research on the electron theory of metals, delivered a series of lectures on the physics of metals at the National University, Bogota, Columbia.

H. MYRL STEARNS, formerly in charge of the Tube Research and Development Laboratory and of tube production at Sperry Gyroscope Co., has been appointed vice-president and general manager of

THE H. H. SCOTT 210-A AMPLIFIER IS THE LOGICAL CHOICE IN



CUSTOM INSTALLATIONS

for realistic reproduction of
Broadcast and Recorded Music

Built to laboratory standards of electrical, mechanical, and musical excellence, this 20-watt amplifier includes these features . . . proved essential to satisfactory custom performance in both FM and AM radio reproduction as well as in record playing.

Extended listening range . . . 30 to 20,000 cycles, with negligible intermodulation or transient distortion,

**Dynamic noise suppressor . . . designed particularly for this unit . . . allows widest use of high- and low-frequency gain,*

Twenty-watt output . . . with less than 2% harmonic distortion; range and power-handling capability exceed RMA broadcast station requirements,

Minimum controls for maximum flexibility . . . easy selection of exact tonal balance to please every ear.

GUARANTEED FOR A FULL YEAR

FOR RADIO RECEPTION

. . . the H. H. Scott 210-A enhances enjoyment of both FM and AM broadcasting, minimizing clicks, whistles, and noise.

IN RECORD REPRODUCTION

. . . the H. H. Scott 210-A laboratory amplifier provides unsurpassed realism, with freedom from scratch, hiss and rumble.

For full details, request Bulletin 4811-E.

*Licensed under U.S. and foreign patents pending and issued.



HERMON HOSMER SCOTT, INC.
"PACKAGED ENGINEERING"
385 PUTNAM AVE. • CAMBRIDGE 39, MASS.

PORTABLE RADIO MADE ESPECIALLY FOR CHILDREN!
BUILT INTO A GIANT PHONE!

DIAL A STATION • PROGRAMS COME THRU RECEIVER!
 'THE LONE RANGER'
 'BUCK ROGERS'
 'THE SHADOW'

OR ANY PROGRAM

VOLUME CONTROL

A Real Child's Radio
COMPLETE WITH AERIAL!

Now Junior can listen to serials and mysteries without disturbing anyone. Sister can listen to her favorite programs while Mother listens to another radio. It's really a child's very own. The telephone "dial" is a carefully pre-set, highly selective radio dial. Brings in any station within a 100 mile radius. Tuned for every radio frequency from 540 to 1600 kilocycles. Includes all the features of expensive portables.

- RADIO PHONE HAS THESE!**
- Private earphone for hours of non-disturbed listening.
 - Special long life battery—Only the flashlight battery need be replaced.
 - Beautiful plastic telephone case.
 - Factory guarantee against defects of material or workmanship.

only \$4.98
 plus 3¢ for NEW POWERHOUSE LONG LASTING BATTERIES!

This sensational new radio is complete in every detail. Includes its own tube and a special, easily attached aerial that brings in programs with plenty of volume. Your Radiophone comes to you complete. Any child will reap rich benefits from having his own radio. For education, amusement, rainy-day entertainment, there's nothing like a Radiophone for keeping every youngster occupied. These perfectly engineered radios are available in limited supply—so mail for your order today. Satisfaction guaranteed. **SEND NO MONEY—pay postman only \$4.98** plus \$1.00 for long life battery and few cents postage—OR remit by check or money order and we pay postage.

Prudential Sales Co., Dept. E-11
 141 Broadway, New York 6, N.Y.

MIGHTY MITES OF RECORDING!

For cutting —
Brilliantone
 RECORDING NEEDLES

For cutting direct on all coated aluminum, paper, or glass base discs. Machine-lapped to insure a mirror-like finish... a clean, quiet-cut groove.

For playback —
Actone
 TRANSCRIPTION NEEDLE
 100% SHADOWGRAPHED

Made to fit the groove cut by the Brilliantone Recording Needle. Used by top radio stations and transcription companies.

Products of **Bagshaw**
 Famous for Fine Needles Since 1892

For New Catalog and Current Price Lists, write to: Advertising Division

H. W. ACTON CO., INC.
 Sole Distributor
 370 Seventh Ave., New York 1, N. Y.

NEY Precious Metals in Industry

YOUR DESIGN PROBLEM SIMPLIFIED WITH THE USE OF ONE OF OUR STANDARD CONTACTS

HEADED AND FORMED WIRE CONTACTS

This simplified chart shows the form and overall dimensions of a few of the many types of contacts made from Ney Precious Metal Alloys with electrical and physical properties that have proved exceptionally satisfactory for brush or wiping contact applications. Full technical and test data are available on request. Other Ney Precious Metal Alloys have solved many special industrial application problems. Consult us freely without obligation.

Write or phone (Hartford 2-4271) our Research Department.

THE J. M. NEY COMPANY 179 ELM STREET • HARTFORD 1, CONN.
 SPECIALISTS IN PRECIOUS METAL METALLURGY SINCE 1812

NEY GOLD

REDUCE ASSEMBLY REJECTS WITH...

TINNED STEATITE HERMETICALLY SEALED TERMINALS

GENERAL CERAMICS and STEATITE CORPORATION
 STEATITE INSULATORS

- ... THAT WITHSTAND HIGH SOLDERING TEMPERATURES
- ... ARE IMMUNE TO ROUGH SHOP HANDLING
- ... HAVE TINNED SHOULDER FOR RAPID ASSEMBLY
- ... FOR 200°C SERVICE ON SPECIAL ORDER

A tinned surface, permanently bonded to the glazed body of these terminals permits rapid soldering to any metal enclosure. Exceptional strength of the steatite body practically eliminates assembly rejects that frequently result when other types of terminals are subjected to soldering temperatures or rough handling. Leads are brought out through an axial hole in the center of the bushing and terminated on the tinned lug. A drop of solder on the hole effects a complete hermetic seal. For complete information concerning tinned steatite terminals, call or write today.

General CERAMICS and STEATITE CORP.
 OFFICES and PLANT CROW'S MILL ROAD, KEASBEY, N. J.

MAKERS OF STEATITE, TITANATES, ZIRCON PORCELAIN, ALUMINA, LIGHT-DUTY REFRACTORIES, CHEMICAL STONWARE

A practical and concise treatment of the **FUNDAMENTALS OF ELECTRIC WAVES**

Second Edition

By HUGH H. SKILLING

Professor of Electrical Engineering and Executive Head of the Department, Stanford University

This book clearly presents the principles of electro-magnetic theory and their practical applications to engineering practice. The author has placed particular emphasis on the basic ideas of Maxwell's equations, and has included many examples to demonstrate them. The rationalized mks system of units has been introduced throughout the book, and explanatory notes in the early chapters clarify this system for those used to the cgs system.

Completely up to date

Much new material has been included in this second edition. The latest information on cylindrical and rectangular wave guides has been incorporated, and there has been an increase and reorganization of the data on the reflection of waves and on antennas. The discussion of wave transmission through semi-conducting media and in ionized regions has been expanded.

Contents include:

Experiments on the Electrostatic Field; Vector Analysis; Certain Theorems Relating to Fields; The Electrostatic Field; Electric Current; The Magnetic Field; Examples and Interpretation; Maxwell's Hypothesis; Plane Waves; Reflection; Radiation; Antennas; Wave Guides; Waves in the Ionosphere.



1948

254 pages

\$4.00

ON APPROVAL COUPON

JOHN WILEY & SONS, INC.
440 Fourth Ave., New York 16, N. Y.

Please send me, on 10 days' approval, a copy of Skilling's FUNDAMENTALS OF ELECTRIC WAVES. If I decide to keep the book, I will remit price plus postage; otherwise I will return the book postpaid.

Name

Address

City State.....

Employed by

(Offer not valid outside U. S.)

E-11-48

Varian Associates, new microwave and electronic research and development laboratory at San Carlos, Calif.

GEORGE F. MURPHY, with General Electric Co. in Schenectady since 1913, was appointed manager of the equipment development works of GE's Electronics Department.



G. F. Murphy



J. T. Lucas

JOHN T. LUCAS, formerly in charge of product engineering for all Sylvania proximity fuze plants in Pennsylvania, has been appointed supervisor of quality control and customer service for the Huntington Radio Tube Plant of Sylvania Electric Products Inc.

A. C. GABLE, formerly assistant engineer, was recently appointed division engineer of GE's Tube Divisions, Schenectady, N. Y.



A. C. Gable



E. W. Stone

ELLERY W. STONE, executive vice-president of Federal Telephone and Radio Corp., has been elected president of that organization and its subsidiary, the International Standard Electric Corp.

EDWIN H. COLPITTS, holder of 24 U. S. patents on telephone inventions and director of the Engineering Foundation in New York since 1941, was presented with the 1948 Cresson Medal by the Franklin In-

The types you need await your order!



Electronic-tube SOCKETS

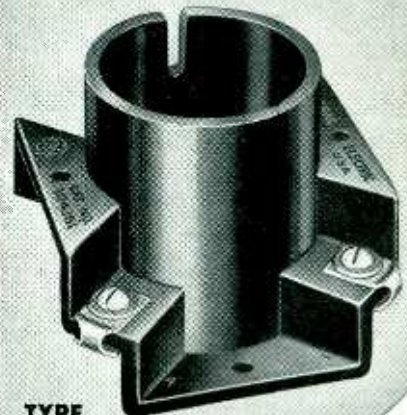

TYPE 104J51

YOU can buy General Electric sockets now... when you buy G-E tubes. These quality sockets were designed specifically for G-E power tubes, rectifiers, thyratrons, etc. They fit, they last. They aid in obtaining optimum performance from G-E tubes in service.

It's convenient to purchase G-E sockets along with G-E tubes, because you get them from the same source, making it easier to order, and simplifying paperwork.

One manufacturer as a source of supply, means one-manufacturer responsibility for both products. Use G-E tubes and G-E sockets as a team; play safe by demanding the G-E brand throughout! Prices and full details are available from your nearby G-E electronics office, or write to Electronics Department, General Electric Company, Schenectady 5, New York.

183-G5-8850

GENERAL ELECTRIC

BAACH-INTERNATIONAL

EIGHT HEAD HOT-CUT FLARE MACHINE

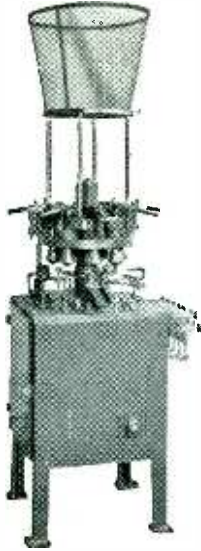

Automatic throughout.
Can be synchronized with automatic Stem machine.
Cuts off and flares in one operation.
Production 1250 flares per hour. For miniature flares, fluorescent starters, standard size lamps, fluorescent and radio tubes.

RANGE OF MACHINE
Glass tubing
27 to 45 gauge
Length of flares
5 mm. to 80 mm.
Forms flares up to
47 mm. diam.
Net weight, 960 lbs.
Gross weight
1450 lbs.

Dimensions
24"x24"x72" high

INTERNATIONAL MACHINE WORKS

Manufacturers of High Vacuum Pumps, Automatic Machinery for Incandescent Lamps, Electronic Tubes since 1916.

2027 - 46TH STREET
NORTH BERGEN, N. J., U. S. A.

Tel. UNion 3-7412.
Cable Address "Intermach" North Bergen, N. J.

WANTED

Middlewestern manufacturer has excellent openings for two engineers:

CIRCUIT ENGINEER

Must be experienced in measurement work, FM and television frequencies, and have thorough knowledge of the performance characteristics and correct application of ceramic capacitors.

CERAMIC ENGINEER

Must be experienced in all phases of the development and manufacture of high dielectric ceramic body capacitors.

Kindly give full information covering your educational background, practical experience, age, dependents, and compensation expected. Address

P-6702, Electronics,
520 North Michigan Ave., Chicago 11, Ill.

*New Tools You Should Have
for* **PRESSURE RESEARCH**



The Syncro-Marker PRESSUREGRAPH

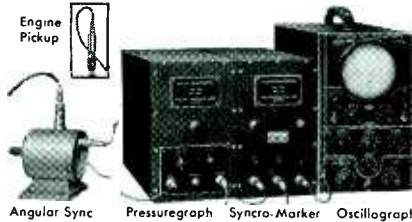

Angular Sync Pressuregraph Syncro-Marker Oscillograph

Here is your complete answer in instrumentation for checking pressure variations, both regular and instantaneous. Provides oscillograph pictures showing relation of pressures to engine shaft rotation (top dead center) or indications in degrees of rotation and also relates pressures to time (milliseconds).

Accurately measures pressure rise with time. Can be applied to hydraulic, gas, steam or pressure line measurement of static, dynamic or instantaneous pressures. New detachable diaphragm permits measurement in any pressure range from vacuum to 14,000 p.s.i.

Now used in oil fields by many leading producers.

ELECTRO PRODUCTS LABORATORIES

549 W. Randolph St.

Chicago 6, Ill.

Phone STate 2-7443

ITS LITERATURE



Write for your copy of "Pressure Patterns" illustrating typical Pressuregraph applications; and "Pressure Indications in Engine Fuel Research," giving data on dynamic studies of pressure waves.

PLANO-CONCAVE QUARTZ CRYSTALS

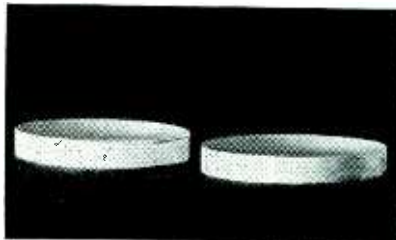

Use Clark plano-concave crystals for maximum prefocused ultrasonic output.

- * 250 kc to 2000 kc
- * 1 cm to 10 cm diameter
- * 100 mm to 500 mm radius of curvature
- * gold or silver plating optional

Complete ultrasonic transducers with impedance matching network available for use under insulating or non-insulating liquids.

CLARK CRYSTAL CO.

MARLBORO, MASS., U.S.A.

Export Department
Rocke International Corp.
New York, N. Y.

FREE

**ALLIED'S
NEW 1949
RADIO
CATALOG**



**Everything in Radio
and Electronic Supplies**

**Complete, Expert Service
for Radio Engineers**

You'll find everything you need in radio and electronic equipment for laboratory and development work, in the new 180-page ALLIED Catalog. Rely on one dependable source for the world's largest stocks—thousands of parts, tubes, tools, books, test instruments, sound apparatus—ready for instant expert shipment at lowest market prices. Write today for your FREE copy of ALLIED'S newest Buying Guide.

ALLIED RADIO

ALLIED RADIO CORP., Dept. 11-L-8
833 W. Jackson Blvd., Chicago 7, Ill.

Send FREE New ALLIED Catalog.

Name.....

Address.....

POLARAD

LABORATORY Equipment

for studio • laboratory • manufacturer.

20 MC VIDEO AMPLIFIER

Model V

- Flat frequency response from 100 cps to 20 mc. ± 1.5 db.
- Uniform time delay of .02 micro-seconds.
- Gain of 50 db.
- Frequency compensated high impedance attenuator calibrated in 10 db steps from 0-50.
- Fine attenuator covers a 10 db range.
- Phase Linear with frequency over entire band.

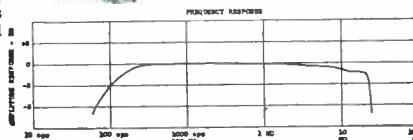

This unit is designed for use as an oscilloscope deflection amplifier for the measurement and viewing of pulses of extremely short duration and rise time, and contains the Video Amplifier Unit, Power Unit and a Low Capacity Probe.

Specifications:

Input Impedance: Probe—12mmf + 470,000 ohms; Jack—30mmf + 470,000 ohms; Output Impedance 18mmf + 470,000 ohms each side push pull; Max. input Volts 500 peak to peak with probe; Max. Output Volts 120 volts peak to peak (push pull); Power: 115 volts 50/60 cps AC Line; Size 19 1/4" x 22" x 14 3/4".



9 FERRY STREET NEW YORK 7, N. Y.

TELEVISION ENGINEERS and CONSULTANTS TO THE NATION'S LEADING TELEVISION STATIONS

stitute, Philadelphia, for achievements leading to the development of practical systems of long-distance communication.

C. RUSSELL COX, formerly sales manager and chief engineer of Andrew Corp., Chicago, Ill., has taken over the newly-created office of director of sales and engineering.



C. R. Cox



J. S. Brown

JOHN S. BROWN, associated with Andrew Corp. since 1943, has been promoted from assistant chief engineer to chief engineer.

WALTER F. KEAN, in charge of the company's broadcast consulting division since 1944, is now sales manager at Andrew Corp., Chicago, Ill.

USE B&W FACILITIES

to step up YOUR production!



View of 2 KW amplifier assembly line at Barker and Williamson's Bristol, Pa. plant.

NOW IN PRODUCTION AT B & W

Complete Radio Transmitters—Dual Diversity Converters, Control Units and Frequency Shift Exciters for Radio Teletype Transmission—Special Test Equipment—Redesign, Modernization and Modification of Existing Equipment—Machine Work—Metal Stamping—Coils—Condensers—Other Electronic Devices in a Wide Range of Types.

From the simplest to the most complex electronic device, B & W is equipped and prepared to meet your most exacting needs. Three B & W plants, comprising 150,000 square feet, completely equipped with a competent engineering staff; machine shop; tool

room including all machines for drilling, milling, turning, stamping and forming metals and plastics, and a complete woodworking shop, are ready to go to work on your design and production problems. Your inquiries are invited. Write Dept. EL-118 for prompt reply.



W. F. Kean



O. S. Duffendack

O. S. DUFFENDACK, until 1944 professor of physics at the University of Michigan where he directed research for 16 years, and now president, vice-chairman of the board and director of research for Philips Laboratories, Inc. at Irvington-on-Hudson, N. Y., was recently decorated with the ribbon of the King's Medal for Service in the Cause of Freedom, by the British Consul General, for services to the Allied war effort as division member and chief of a section of NDRC.

LEWIS W. CHUBB, director emeritus of the Westinghouse Research Laboratories and recipient of the 1947 John Fritz Medal, has retired after 43 years of scientific research.

BARKER & WILLIAMSON, Inc.
237 FAIRFIELD AVENUE UPPER DARBY, PA.

BUSINESS OPPORTUNITY

• The Technical Director and owner of well known British firm manufacturing electrical measuring and testing equipment, seeks to contact active U. S. business man with a view to opening works in U. S. A.

• It is intended to produce equipment which is not already on the U. S. market. In the first instance please reply stating experience in this field and amount of capital available.

BO-6513, Electronics

330 West 42nd St., New York 18, N. Y.

Baer can supply your vulcanized and phenol fibre fabrications



* Baer fibre is versatile... can be stamped, punched, drilled, tapped, milled, sheared, sawed and shaved to specification.



SEND BLUEPRINTS AND SPECIFICATIONS—NO OBLIGATION!

When you use these tough, light-weight and inexpensive parts, you build their many advantages into your own product. Fabricated to order, BAER FIBRE washers, special shapes, terminal boards, and other parts are accurately and uniformly produced to specification in any quantity. Selection of grades by physical and electrical qualities, permits application to a wide range of operating conditions and requirements. Investigate now!

LITERATURE ON REQUEST

N. S. BAER COMPANY

MONTGOMERY ST., HILLSIDE, N. J.

HERE'S BIG HELP IN TERMINAL WIRING!

The New **JONES FANNING STRIP**

The correct wire to correct terminal every time!

Connections are made through Fanning Strip, on bench or anywhere apart from barrier strip, and quickly slipped into assembly.

Use with Jones Barrier Terminal Strips, Nos. 141 and 142, for 1 to 20 terminals.

Simplifies soldering. Insures correct connections. Saves time. Ideal for harness or cable assembly. Brass terminals, cadmium plated. Bakelite mounting. Send for complete data.



9-141 Barrier Strip

9-161 Fanning Strip. Pat. applied for.

HOWARD B. JONES DIVISION
Cinch Mfg. Corp.
2460 W. GEORGE ST. CHICAGO 18, ILL.

COMPOUNDS

Scientifically compounded for specific applications from waxes, resins, asphalts, pitches, oils, and minerals. Available in wide range of melting points and hardnesses. Special potting compounds are heat conducting and crack resistant at extremely low temperatures. Recommendations, specific data, and samples will be furnished on request.

for

IMPREGNATING

radio coils
transformer coils
ignition coils
wire coverings
paper tubes and forms
porous ceramics

SEALING

condensers
batteries
switch base terminals
socket terminals
light fixtures

POTTING

Radio Transformers
Light Units
Loading Coils
Condensers

DIPPING

Coils
Transformers
Condensers



BIWAX CORPORATION

3445 HOWARD STREET
SKOKIE, ILLINOIS



MODEL 2B 0.45
Actual size illustrated

RECHARGEABLE • NON-SPILL

VITAMITE
1 OZ. BATTERIES

(Smaller Than 2 Pen-Lights)

IDEAL FOR USE WITH

Miniature And Sub-Miniature Filament Type Tubes for HEARING AIDS, PORTABLE EQUIPMENT, ETC.

LARGER MODELS ALSO AVAILABLE
Write for Data and Literature

THE VITAMITE COMPANY

227 West 64th Street

New York 23, N. Y.

ANOTHER

TECH LAB FIRST!

NOW ON ALL
ATTENUATORS
AND
POTENTIOMETERS

Silver Alloy Contacts

New Silver Alloy contacts make possible improved Attenuators and Switches in smaller sizes.

- 1 Greater Creepage Distance—thus better insulation.
- 2 No silver migration.
- 3 Greater silver surface to carry current.
- 4 Lower contact resistance.
- 5 Better mechanical operation of switch.
- 6 Less capacity between contacts—better frequency characteristics.
- 7 Better clearance to ground.

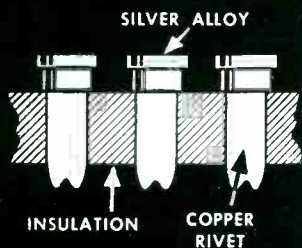

TECH
LABORATORIES, INC.®

Manufacturers of Precision Electrical Resistance Instruments

BERGEN BLVD., PALISADES PARK, N. J.
Tel: LEonia 4-3106

ONE OF A SERIES

UNIFORM DAMPING

**WHY BURLINGTON PANEL
INSTRUMENTS PROVIDE
UTMOST RELIABILITY . . .**

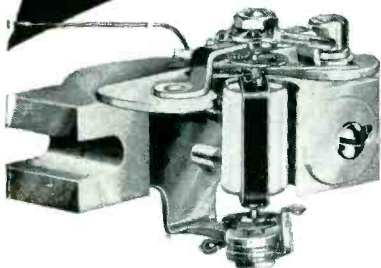

MAGNETIC SHUNT as used by Burlington insures uniform damping characteristics. All ranges AC and DC available in 2½", 3½", 4½" rectangular or round case styles and are fully guaranteed for one year against defects in workmanship or material. Refer inquiries to Dept. F 118.

Burlington INSTRUMENT COMPANY
BURLINGTON, IOWA

NEW BOOKS

Vacuum Tube Circuits

BY LAWRENCE BAKER ARGUIMBAU, Assistant Professor, Electrical Communication, Massachusetts Institute of Technology; John Wiley & Sons, Inc. 1948, 668 pages, price \$6.00.

IN A REALISTIC appraisal of the field, the author of a rather unusual book admits the temporary value of texts on electronics, so rapidly does the art change. His aim, therefore, is to equip students and engineers with the intellectual ability to solve problems rather than to describe equipment or circuits. He dissects circuits to their basic status, shows how to determine what these circuits do, and illustrates his methods with many useful examples. Problems are provided to test the reader's ability to learn from the text.

The book is unusual in that it does not follow the cut-and-dried pattern so customary in books on electronics. One is likely to find in an early portion of the book material usually discovered in the final chapter of the conventional book. The idea is not to present a slowly-developed and consistent treatment but to bring to the student the techniques of solving problems—in brief to aid the student to think.

In twelve chapters Professor Arguimbau treats many aspects of radio communication, diodes and rectifiers, triodes, pentodes and linear amplifiers, transient response in video amplifiers, amplitude modulation and tuned amplifiers, power amplifiers, oscillators, inverse feedback, amplitude and frequency modulation, pulses and television and microwaves.

From unofficial reports, the author is a popular professor—and his book should be well received.
—K. H.

Principles and Methods of Telemetering

BY PERRY A. BORDEN AND GUSTAVE M. THYNELL. Reinhold Publishing Corporation, New York, 1948, 230 pages, \$4.50.

The material contained in this book fully justifies its title. Skillfully blending basic principles and current practice, the authors have produced a thoroughly practical text, of value to the potential user

SAVE DIRECT FROM FACTORY Economy SPEED FLASH UNIT KIT



KIT COMES COMPLETE. HAS STANDARD G.E. R.C.A. (etc.) PARTS CAN BE ASSEMBLED READY TO USE IN A FEW HOURS. FOLLOW SIMPLE INSTRUCTIONS. ALL YOU NEED IS SOLDERING IRON, PLIERS AND SCREW DRIVER.

The Economy Flash Unit Kit has been sold in stores throughout the country, already assembled for \$98.00. You save, by assembling the kit yourself, more than \$55.00.

Comes complete including: chassis, 60 watt second condenser, relay transformer, vibrator, flash indicator, switch, 3 outlet plugs, flash adapter assembled with bulb and cord.

Operates from
2 dry cell batteries.

Set of 2 batteries,
\$1.00 extra

\$39.95
tax included

Send no money. Pay postman \$39.95 plus few cents postage upon delivery, or remit by check or money order and save C.O.D. charges.

Prudential Sales Co., Dept. E-F-11
141 Broadway, New York 6, N.Y.

TELEVISION HIGH VOLTAGE METER 0 to 30 KV



AN ABSOLUTE
MUST FOR
TELEVISION
WORK

METER SPECIFICATIONS

Voltage Range: 0-30 Kilovolts at 50,000 ohms per volt sensitivity. Measures high voltage circuits with very light loading.

Polarity Reversing Switch: Permits measuring of positive or negative voltages from ground with maximum safety. Switch may be operated without arcing while the voltage is being applied. Off position of this switch locks the sensitive meter movement for transportation.

Special Terminals: Provided for oscilloscope connection to observe percentage of ripple, also waveform and frequency of ripple while checking voltage. The circuit used permits scope readings over an extremely wide frequency range.

A square cased 4" meter with an easy to read scale. Overall Size of Case: 7" wide, 9" long, 5" high. Net Price.....\$67.50

Include 25% Deposit with Order, Balance C.O.D.

Pioneers in Projection Television
SPELLMAN TELEVISION CO., INC.
130 WEST 24th STREET • NEW YORK 11, N. Y.



PIPE COUPLINGS

ELECTRICALLY HEATED PRESSURE HEADS

CONTINUOUS FILM RECORDING CAMERAS

AND EQUIPMENT FOR CATHODE RAY

OSCILLOGRAPHY, ETC.



We undertake the Design, Development and Manufacture of any type of Optical-Mechanical -Electrical Instrument. Including Cameras for special purposes.

Avimo Limited, Taunton, England • Telephone Taunton 3634



Preferred

as a source of precision - made WASHERS and STAMPINGS manufactured to your specifications

CUP WASHERS
for Binding Screws



WHITEHEAD STAMPING CO.

1691 W. Lafayette Blvd.

Detroit 16, Michigan

DANO plus KNOW - HOW bring you COIL PERFECTION

Our Engineering Department is at your service. Samples cheerfully analyzed without obligation.

TRANSFORMERS Made To Order

Not just any coil but the exact coil winding you need, skillfully made to your exact requirements. The dependability and service behind our name are your assurance of perfect coil performance.

THE **DANO**

ELECTRIC CO. 93 MAIN ST. WINSTED, CONN.

- ★ FILTERS AND EQUALIZERS
- ★ TOROIDAL FILTER INDUCTORS
- ★ LOADING COILS
- ★ TOROIDAL TRANSFORMERS

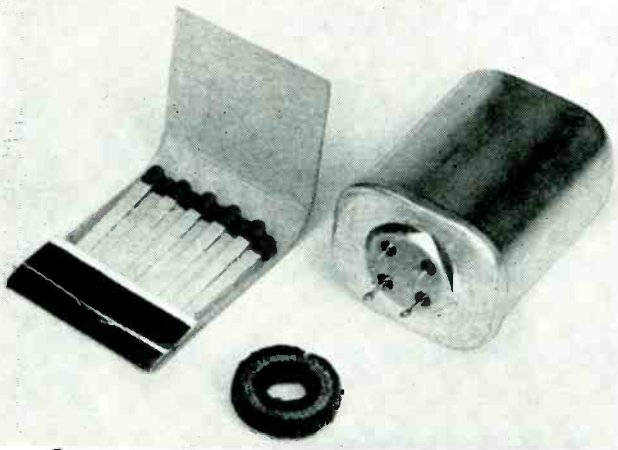

Miniature band pass filter with 60 decibels attenuation in rejection bands and using pictured "wedding ring" coils.

We wind high Q toroid coils to 4" outside diameter and down to 1/4" residual inside diameter, wire sizes 22 to 38.

We offer a complete filter design and production service, plus a bank of toroid winders available to produce coils to your specifications. All popular core sizes are stocked and cover frequencies to 200 KC.

Your inquiries on special requirements are invited. Our immediate attention is assured.

COMMUNICATION ACCESSORIES COMPANY

110th St. and Hillcrest Road • Box 345 • Hickman Mills, Missouri

for Flight Research



Specially developed for recording in flight, the TYPE S12-A OSCILLOGRAPH is ideal for operation under acceleration or vibration. The S12-A is a complete instrument with internal governor motor, gear-driven record, timing device, record numbering, automatic record-length control, and record footage indicator. Case is rigid cast aluminum only ten inches wide by 18 inches long. Complete instrument weighs only 35 pounds.

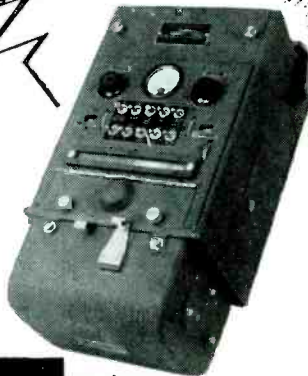

Hathaway
Type S12-A twelve-element
Recording Oscillograph

WRITE FOR
BULLETIN SP-167A



Microwave Receivers

Volume 23 in MIT Radiation Laboratory Series, EDITED BY S. N. VAN VOORHIS. McGraw-Hill Book Co., New York, 1948, 618 pages, \$8.00.

A COMPREHENSIVE treatment of microwave receivers is found in this volume. The book contains 21 chapters written by nineteen contributing authors. The first nine chapters deal with electrical elements of microwave receivers, such as microwave mixers and oscillators, i-f amplifiers, second detectors, gain-control circuits and video amplifiers. The mechanical construction of microwave receivers is reviewed in Chapter 10, and Chapters 11 and 12 discuss test equipment. The last nine chapters are devoted to an analysis of microwave receivers for several specific applications. Some of the receivers considered in these chapters are: An Airborne Receiver Incorporating Anticlutler Circuits, A Receiver for an Automatic-Tracking Radar, Wide-band F-M Receiver, Beacon Superheterodyne Receivers, Crystal-video Receivers and Superregenerative Receivers. These several types of receivers are

SAFE... SIMPLE

HIGH VOLTAGE TV TESTS
TO 30,000 VOLTS
WITH THE NEW
PRECISION SERIES TV
Super High Voltage Safety Test Probes

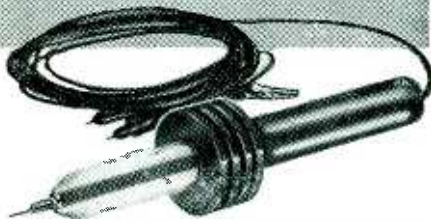

Now... the TV high voltage test problem solved with safety and operational confidence.

A super high voltage, custom-molded test probe, "Application Engineered" for the job... tested on the job... approved for the job.

Designed for SAFETY FIRST.

Rapid removal and interchange of the cartridge multiplier permits the TV probe to be used with more than one multi-range test set, via purchase of appropriate cartridge.*

Series TV High Voltage Test Probes are now on display at leading radio parts distributors and are available as follows:

TVP—High Voltage Test Probe LESS multiplier cartridge. \$12.35 Net

TV-1—Model TVP WITH Cartridge for Precision Series EV-10 VTVM. \$15.45 Net

TV-2—Model TVP WITH Cartridge for Precision (or any) 20,000 ohms per volt test set with built-in 6000 V. D.C. range. \$15.45 Net

*Stock and special value multiplier cartridges available to match popular high sensitivity test sets.

Series TV High Voltage Test Probes provide direct kilovoltmeter facilities with existing high sensitivity test sets, and VTVM's such as the "Precision" models described below: Write for illustrated 1948 catalog describing complete line of electronic test instruments.

—MODEL 85—

Lab. Type 20,000 ohms per volt AC-DC test set. 34 rotary selective ranges to 6000 V., 60 Megs., 12 Amps., 70 DB, 4½" meter. \$38.75

—MODEL 858-L—

20,000 ohms per volt Multi-Master, AC-DC V-O-M. 54 push-button operated ranges to 6000 V., 600 Megs., 12 Amps., 70 DB, 4½" meter. \$54.10

—MODEL EV-10-MCP—

Multi-range, zero-center VTVM plus AC-DC V-O-M facilities to 6000 V., 2000 Megs., 12 Amps., 70 DB. With large 7" meter. \$89.95

—MODEL 10-54-P—

Electronic Tube Tester, and 20,000 ohms per volt AC-DC V-O-M. Ranges to 6000 V., 12 Amps., 60 Megs., 70 DB, 4½" meter. \$134.40

PRECISION

APPARATUS CO., Inc.
92-27 Horace Harding Blvd.
Elmhurst 10, N. Y.

Export Division, 458 Broadway, New York City,
U. S. A. Cables, MORHANEX

NEW BOOKS

(continued)

used to illustrate combinations of the circuits treated in the preceding chapters.

In view of the large number of authors who contributed to this volume, the coherence attained in the treatment of the several phases of the subject is to be commended. It should be admitted that one reading the book from cover to cover will encounter some repetition. On the other hand, the completeness with which each chapter presents its subject makes it ideal as a reference volume. While the discussion of receiver elements such as microwave mixers is of necessity not as exhaustive as found in the Microwave Mixer volume (No. 16), nevertheless a thorough treatment of each subject is provided. The book is written in a clear, easily understood manner. It contains an excellent balance between theoretical and practical information. The text is illustrated with numerous photographs, circuit diagrams and curves.

This volume should prove of great value to anyone interested in the design, test or maintenance of microwave receivers. It will enable the student to obtain a greater understanding of microwave receiver problems.—G. L. BEERS, RCA Victor Division, Camden, N. J.

Elementary Manual of Radio Propagation

EDITED BY DONALD H. MENZEL. Published by Prentice-Hall, Inc., New York, N. Y., 1948, 222 pages, looseleaf binding, \$7.65.

PROFESSOR MENZEL states the objective of this book in the preface when he says, "The range of frequencies useful for communication purposes depends upon a large number of factors, the most important of which are the location of the points of transmission and reception, the distance between the stations... By following the rules outlined in this elementary manual, we shall be able to analyze and predict the behavior of radio signals over any type of circuit and have further understanding of the whys and wherefores of our complicated but interesting communication system."

The present text is an outgrowth of a wartime Navy training pamph-

TECHNICAL MANUALS

CUSTOM DESIGNED TO YOUR SPECIFICATIONS

Planned, written and illustrated by a select staff... experts in creating radio and electronic manuals for civilian & military use.

When you call upon Boland & Boyce to create your manuals you are relieved of every detail in their preparation. The entire operation is taken over and completed by a specialized staff with years of experience in publishing books & manuals.

First the requirements for your manual are completely surveyed. The working conditions to which they will be put are studied and the operations or equipment described in the manual are thoroughly analyzed. A complete outline is then prepared and submitted for your approval, along with a dummy of the manual as it will appear when finished. Upon your approval the job is completed and delivered with your satisfaction guaranteed.

Boland & Boyce manuals incorporate only the most modern editorial and illustrative style. Each project is treated with individual attention in technique of presentation and editorial approach. The Boland & Boyce military and civilian manuals now in use throughout the world are our best recommendations.

U. S. Navy
U. S. Signal Corps.
Sylvania Electric Products, Inc.
The National Company
Western Electric Co.
Bell Telephone Laboratories
Maguire Industries, Inc.
Allen B. Dumont Laboratories, Inc.
General Electric Co.
Mine Safety Appliances Co.

Write or wire Boland & Boyce today for more information.

BOLAND & BOYCE INC., PUBLISHERS

Radio Maintenance Technical Manuals
Manual Division M-3
Radio Data Book
Video Handbook
Montclair, N. J.
CHICAGO: 228 No. LaSalle St.



GENERAL ELECTRIC THERMOCELLS for ACCURACY

G-E thermocells are as small as it is practical to make them and still retain all of the advantages which broaden their field of application and simplify the problems of design engineers.

Design engineers will appreciate especially the octal base feature. Add in these other major advantages in G-E thermocells—then specify them for every job you have under consideration.

1. G-E thermocells are filled with an inert gas and sealed to inhibit atmospheric contamination of both crystal and thermostat contacts.
2. Warm-up time is extremely short because of the low thermal capacity of the unit as a whole.
3. The heat loss is low, which permits low operating power and consequently less load and longer life for the thermostat contacts. Radiant heat loss is minimized by the polished chromium-plated shell.
4. Durable platinum-iridium thermostat contacts are used in G-E thermocells.

A typical example of the G-E line of thermocells is the Type G31:

Frequency Range 2500-10,000 K.C.
 Size and Shape Same as 6L6
 Freq. Adj. at Normal Ambient Temperature0015%
 Ambient Temp. Operating Range . . 0 to 55°C.
 Long Time Frequency Stability better than001%
 Heater Power 2.6 Watts
 Crystal Cuts Normally Used AT & BT
 Electrodes and Mounting Pressure Airgap
 Warm-up Time 15 Minutes

For further information on this and other G-E thermocells, quartz crystals and germanium diodes write today to: General Electric Company, Electronics Park, Syracuse, New York.

186-G2

GENERAL ELECTRIC

NEW BOOKS

(continued)

let that resulted from the need for rapid instruction of large numbers of personnel having a limited technical background.

Approximately half the book is devoted to the properties of the ionosphere and procedures for calculating quantities such as interstation distance, great-circle maps, maximum usable frequency, and lowest useful high frequency. Intermingled with the computation rules is a large amount of descriptive material concerning the general characteristics of the ionosphere and their relation to the sun, solar phenomena such as sunspots and prominences, and terrestrial and cosmic noise. This material makes highly readable text and is useful in giving a qualitative understanding of ionospheric propagation, but the manner in which it is distributed throughout the manual does not contribute to efficient use of the computational material.

The second half of the book is divided principally among ground-wave transmission, methods for calculating field strengths at frequencies above 30 mc, and discussion of the effect of the atmosphere on coverage and its operational implications. Calculation methods are necessarily limited to the case of a well-behaved atmosphere, but anomalies are discussed in an interesting manner.

An excellent feature of the manual is the predominance of well-designed alignment charts and nomograms. The arithmetical work involved in computation is reduced to a minimum number of simple operations with quantities obtained from the charts. The few accompanying equations are written with coefficients collapsed to numerical values, and are not always well labeled with regard to units. Such a procedure is suitable for rapid calculation after the system has been learned but is likely to annoy the informed person who is attempting to follow the material or compare it with other techniques. There are no derivations in the text, but some of the important relations are derived in two highly condensed and not particularly readable appendices.

In keeping with the elementary nature of the text, many compli-

KNOW THE TRUE FACTS OF OPERATION AT HIGH FREQUENCY with CW-AM-FM-TV TRANSMITTERS

use

TERMALINE DIRECT-READING RF WATTMETERS

Frequency 30 to 500 MC
 Power Rating To 2500 Watts
 Impedance 51.5 OHMS
 Accuracy Within 5% of full scale



MODEL 61

POWER RATING 80 Watts
 Standard Ranges 0-15 & 0-60 W
 (Dual) 0-20 & 0-80 W
 Special Ranges 0-1 & 0-2½ W
 0-2½ & 0-10 W
 0-1 & 0-5 W
 0-1 & 0-10 W
 0-2 & 0-20 W

MODEL 67

POWER RATING 500 Watts
 Standard Ranges (Triple) 0-25, 0-100, 0-500 Watts

MODEL 67C (water-cooled)

POWER RATING 2500 Watts
 Single, Dual or Triple ranges to order.



BIRD ELECTRONIC CORPORATION

1800 E. 38th ST., CLEVELAND 14, OHIO

Represented on the West Coast by:
 NEELY ENTERPRISES
 7422 Melrose Blvd., Hollywood 46, Calif.
 Instrumentation for Coaxial Transmission

Vital Aids TO

**MANUFACTURERS OF
MINIATURE TUBE RADIOS
AND EQUIPMENT**



★ Star Miniature Socket Wiring Plugs for accurate alignment of miniature socket contacts during wiring. Precision cast of zinc base alloy—pins of stainless steel. #JE-9 (9 pin); #JE-10 (7 pin).

★ Star Miniature Tube Pin Straighteners (with stainless steel insert) to obtain a perfect fit when the tube is placed in the equipment. #JE-15 (9 pin); #JE-13 (7 pin).



Scientifically designed — Precision made
Immediate Delivery in Any Quantities

★ STAR EXPANSION PRODUCTS CO., INC.

147 CEDAR STREET, NEW YORK 6, N. Y.

Visit Our Display Booth, I.R.E. Show, March 7-10, 1949

The theory and application
of electronics in industry

INDUSTRIAL ELECTRONICS REFERENCE BOOK

By *Electronics Engineers of the
Westinghouse Electric Corp.*

This book was compiled to answer the need for complete and clear information on the application and design of industrial electronic equipment. Written by a group of engineers, each an expert in his particular branch of electronics, the *Industrial Electronics Reference Book* contains the most recent information on the subject. The material is directed at the practicing engineer. Its aim is to give him a better understanding of the scope and limitations of electronic apparatus as it is applied to industrial processes.



1948 680 Double-column Pages \$7.50

ON APPROVAL COUPON

JOHN WILEY & SONS, INC.
440 Fourth Ave., New York 16, N. Y.
Please send me, on 10 days' approval, a copy of
INDUSTRIAL ELECTRONICS REFERENCE BOOK. If I decide to keep the book, I will remit
\$7.50 plus postage; otherwise I will return the
book postpaid.

Name

Address

City Zone State

Employed by

(Offer not valid outside U. S.) E-11-48

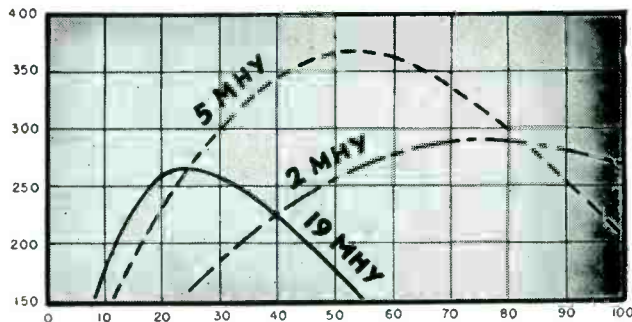

For
**OUTSTANDING
CORE
PERFORMANCE**



Lenkurt Trancors are now being made to the remarkable Q characteristics above. Infinite care is required to make such parts. Available in a broad variety of low-cost standard cores and assemblies, or special items.

Write for catalog

LENKURT ELECTRIC CO.
SAN CARLOS, CALIFORNIA

LENKURT KNOWS HOW

"Where
Professional
Radiomen
Study"

CAPITOL RADIO ENGINEERING INSTITUTE

An Accredited Technical Institute
16th and Park Rd., N.W. Dept. E-11
Washington 10, D.C.



Advanced Home Study and
Residence Courses in Practi-
cal Radio-Electronics and
Television.

Approved for Veteran Training.

WASHERS • SMALL STAMPINGS • WIRE PARTS

TO YOUR SPECIFICATIONS

LONG OR SHORT RUNS

- any quantity
- any material
- any finish

- For prices and
delivery send
blue-print or
sample.

Sheffco Manufacturing Co.

116 W. RUBY AVE. • PALISADES PARK, N. J.

it's an

UNBRAKO

Reg. U. S. Pat. Off.

SELF-LOCKING SOCKET SET SCREW



Pat'd
& Pats.
Pend.

The KNURLED cup point of this popular "Unbrako" Socket Set Screw makes it a **Self-Locker** . . . because the keen edges of the counter-clock-wise KNURLS won't creep, **regardless** of the most chattering vibration. A real fastener, if ever there was one . . . positively **won't shake loose!**

Knurling of Socket
Screws originated with
"Unbrako" in 1934.

Write us for the name and address
of your nearest "Unbrako" Industrial
Distributor and your copy of
the "Unbrako" Catalog.

Over 45 Years in Business

STANDARD PRESSED STEEL CO.

JENKINTOWN, PENNA.

BOX 596

CHICAGO • DETROIT • INDIANAPOLIS • ST. LOUIS • SAN FRANCISCO

Roanwell

A NEW NAME

IN COMMUNICATIONS TERMINAL EQUIPMENT

ROANWELL . . . the successor to Aviometer who for years has provided the communications industry with the finest terminal equipment. Aviometer has been completely reorganized . . . new plant, expanded production facilities and quality control. New engineering talent has been added to the former staff long recognized as tops in its field. These changes and additions now make it possible to provide engineeringly correct, economical and speedy solutions to any terminal equipment problem.

SPECIALISTS IN SPECIAL REQUIREMENTS

In addition to their standard line, designed to meet normal needs, ROANWELL is well equipped to engineer and produce special units to meet the most exacting requirements. Their catalog, now available upon request on company stationery, tells the ROANWELL story and their successful solutions for some of the industry's top manufacturers.

The AVIOMETER Div.

ROANWELL CORPORATION

662 PACIFIC STREET, BROOKLYN 17, N. Y.



Compact, rugged,
light, Folding Hand
set Style 197 shown
in open position.



Style 197 shown in
folded position. Small
and light enough to be
held in one's hand.

NEW BOOKS

(continued)

cated phenomena have been reduced to rules of thumb or much-simplified descriptions; in general, these are interesting and readable but should not be taken too literally. There are numerous errors and half-truths, particularly in connection with the effects of atmospheric refraction, but as no coverage calculations are based upon them little harm is likely to result. There are several well-worded warnings to operators concerning such matters as the interim nature of much of the basic data and the use of "standard" radar targets to check set performance.

This manual will undoubtedly be very useful for its announced purpose, that of training operating personnel in some of the practical aspects of the effects of the propagation path on radio and radar set performance. It is not suitable as a scientific reference or text, but contains some practical material that could be useful to a student after the basic physics of the subject has been mastered.—DONALD E. KERR, *Research Laboratory of Electronics, MIT.*

Fluorescent and Other Gaseous Discharge Lamps

BY WILLIAM E. FORSYTHE AND ELLIOT Q. ADAMS, *Nela Park, Cleveland. Murray Hill Books, Inc., New York, 1948, 292 pages, \$5.00.*

DEPENDING on where you may open this book, it looks like a text on chemistry, physics, photography, illumination, television, or electronics. This is as it should be, because today the discharge of electricity through gases and vapors encompasses all these fields.

Approximately two-thirds of the book is devoted to the fluorescent lamp that was introduced in 1938 and has today become a major source of industrial illumination. The first three chapters trace the physical basis by reviewing light and radiation, characteristics of electrical discharges, and the phenomena of fluorescence, phosphorescence, luminescence and photoluminescence. Engineering details of problems encountered in making straight and circular lamps in various lengths and sizes are covered.

An entire chapter is devoted to fluorescence as applied to television and radar cathode-ray tubes. Valu-

able tables list color, brightness and decay time of various phosphors used as single screens and as cascade screens.

It is significant that much of this book was written during working hours, with drafting and stenographic help being made available to the authors by their employer. The writing of a technical book is for most people the hardest type of work, with relatively small financial recompense, and continued encouragement of this nature can in many cases stimulate competent authors to action. Commendation for the high quality and overall technical value of this book must therefore go to General Electric Co. as well as to the authors.—J.M.

• • •

Books Received for Review

ATOMIC ENERGY. By Karl K. Darrow. John Wiley & Sons, Inc., New York, 1948, 80 pages, \$2. The 1947 series of four Norman Wait Harris lectures delivered at Northwestern University describes to the nonphysicist "the basic facts most pertinent to the transformation of energy of rest mass into energy of motion and energy of heat".

IONOSPHERIC RADIO PROPAGATION. National Bureau of Standards Circular 462, 209 pages, available from Superintendent of Documents, U. S. Government Printing Office, Washington 25, D. C. Remit \$1 in U. S. currency only; foreign orders add one-third to cover postage. Physical and mathematical theories underlying radio-wave propagation by reflection from the ionosphere are brought into understandable relation with practical problems of radio communication. Several problems are worked out in detail to assist the reader in specific applications.

DESIGN OF CRYSTAL VIBRATING SYSTEMS. By William J. Fry, John M. Taylor, and Bertha W. Hennis. Dover Publications, Inc., New York, 182 pages, \$3.50. Eliminates lengthy design computations for systems incorporating piezoelectric materials by presenting design procedures involving graphs based on fundamental piezoelectric relations. Originally published as a confidential war-time report of the NRL.

AMERICAN ELECTRICIANS' HANDBOOK. By Terrell Croft. McGraw-Hill Book Co., New York, 1948, Sixth Edition, 1773 pages, \$6.00. Revision of 1942 edition to agree with 1947 edition of National Electrical Code, with approximately 250 pages of new material on latest developments. An entire new 80-page division deals with electron tubes and circuits as used in industry.

SURVEY OF EXISTING INFORMATION AND DATA ON RADIO NOISE OVER THE FREQUENCY RANGE 1—30 MC. By H. A. Thomas and R. E. Burgess. Radio Division, National Physical Laboratory, His Majesty's Stationary Office, London, 1947, 126 pages, paper cover, 3 shillings. Types of noise that can limit the sensitivity of receivers are considered theoretically and comparison is made with measurements, from which the noise level at various locations can be assessed.

TELEVISION PRODUCTION PROBLEMS. By John F. Royal and ten contributors. McGraw-Hill Book Co., Inc., New York, 1948, 179 pages, \$2.50. Symposium based on lectures given jointly by Columbia University and National Broadcasting Co. One Chapter, The Science of Television, is by NBC engineer F. A. Wankel and presents simplified technical data; the remaining ten chapters cover programming.

be exact...



with this industry-accepted TIME DELAY TIMER

Synchronous motor driven, automatic reset, designed to delay closing or opening of a timed electrical circuit for electronic equipment, heat application, conveyors, X-ray equipment, plastic extrusion and molding, and for recycling operations. Available in maximum intervals of 15, 30 and 60 seconds, 3 or 5 minutes. Bakelite cased, 3 in. diameter.

A few of the timers we build for industry:

- Automatic Reset
- Signaling
- Push-button Automatic Reset
- Panel-mount Time Delay
- Behind-the-panel-mount Time Delay
- Running Time Meters
- Others for special purposes.

We have more than 400 types of timers for you to choose from. Write us your requirements.

INDUSTRIAL TIMER CORPORATION



111 Edison Place, Newark, New Jersey

AUGMENTED ACCURACY...

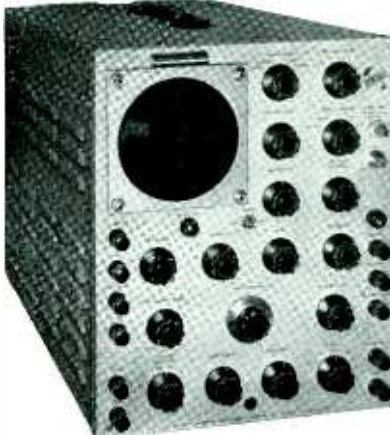

The Tektronix Type 511-A Oscilloscope retains all of the features that have made its predecessor, the Type 511, the universally accepted instrument in its category, **PLUS** a completely new power supply providing full regulation in all DC circuits, including the accelerating voltage. Line voltage fluctuation between 105 and 125 volts produces no noticeable effect on image intensity, sweep speed or deflection sensitivity.

The Type 511-A is a truly portable precision instrument—total weight 50 pounds and self-contained.

TYPE 511-A FEATURES

- Wide band vertical amplifiers (10 mc. 1 stage; 8 mc. 2 stages).
- Continuously variable sweep speed 0.1 sec. to 1 microsec. (10 cm. deflection).
- Vertical amplifiers individually adjusted for optimum transient response at high and low frequencies.
- Calibrated direct reading sweep speed dial, permitting quantitative measurement to 5% accuracy.
- Vertical deflection sensitivity 0.27 V to 200 V per cm. (peak to peak).
- Choice of triggered, recurrent or single sweeps at all speeds.
- 0.25 microsecond video delay line may be incorporated at nominal charge.
- Any 20% of normal sweep may be expanded 5 times.

Price \$795.00 f.o.b. Portland Your inquiry will bring more detailed information and name of the nearest Field Engineering Representative.



Phone, EAst 6197
Cables, TEKTRONIX

712 S. E. Hawthorne Blvd.
Portland 14, Oregon

Backtalk

This department is operated as an open forum where our readers may discuss problems of the electronics industry or comment upon articles which **ELECTRONICS** has published.

Frequency Allocations

DEAR SIRs:

THE faulty assumption in Courtney's article (**ELECTRONICS**, August 1948, p 73) is that monitoring is a sufficient index upon which to base allocations. Such is obviously not the case.

If a given service, e.g., police, is recognized by the FCC, frequencies must, of course, be reserved for an indeterminate period to allow every municipality, county and state to obtain equipment and put it into use. Inevitably there will be a period, varying according to the nature of the service, up to several years when frequencies so reserved have not been put into use in particular areas. Only chaos could result if other services were licensed on the frequencies so reserved for a given recognized service.

The licensing of any service presumes it has been recognized as being in the public interest and its establishment on any frequency can only be done as the result of the purchasing of communication equipment. The displacement of such a service at a later date without having replacement frequencies available simply would mean shutting down the service for lack of frequencies. The purpose of the allocation table, in other words, is to reserve bands of frequencies for the several services. The locations and widths of these bands are intended to represent a balance based upon the relative public interest, convenience, and necessity of each of them.

It is inevitable that some services will exploit their frequencies sooner than others. If adjustments in the allocations were made solely on the basis of the rate of growth of the different services, then the situation that Courtney envisages might,

**A NEW,
improved Fastener
for mounting**

**Miniature
Shield
Cans**

NO. 702 PALNUT
TRADE MARK
SHIELD CAN FASTENER*

- **Strong, positive grip**
- **No tolerance problem**
- **Low assembly cost**

Installs in popular shaped holes shown below

Live spring arch holds can tightly against chassis

Will not pull out until deliberately released



A quick snap of the PALNUT Shield Can Fastener into the chassis provides a secure job, speedily assembled at low cost. Good ground contact is maintained. May be used on any chassis thickness.

SAMPLES and data on PALNUT Shield Can Fasteners sent upon request on your Company letterhead.

*Pat. Pending

The PALNUT Co.

77 CORDIER ST., IRVINGTON 11, N. J.



THE NAME "BARBER" is a guarantee of proved superiorities on Production Lines; in Laboratories; at Test Benches. Let our advanced technologies, experience, skills, facilities, help you with any type of special Electronic units.

Alfred W. Barber

WIDE RANGE VACUUM TUBE VOLTMETER



0.1 to 100 Volts in 5 ranges, A-C & D-C; Easy reading 4 1/2" meter; Permanent accuracy; Probe will not "short" in crowded circuits.

Many other vital features. Ask for Bulletin 28.

HIGH VOLTAGE R. F. ELECTRONIC VOLTMETER

5 to 10,000 Volts in 5 ranges; Frequency 100 K. C. to 100 M. C. within 0.5 D.B. High voltage Coupler attenuates and rectifies radio frequency voltages from 100 K. C. to 100 M. C. and up to 10,000 r.m.s. Many other features. Get Bulletin R.F.



JUNIOR R. F. VOLTMETER



0.25 to 300 r.m.s., in 5 ranges. 20 cycles to over 300 M. C. This simple, well-built Voltmeter is of laboratory quality, with all unnecessary complications eliminated. Write for Bulletin LKV.

ALFRED W. BARBER LABORATORIES



34-04 Francis Lewis Blvd Flushing, N. Y.

The Latest News of Science Now Yours in One Big Magazine!

Now at last you can keep up with the new inventions and discoveries of science that affect you and your industry. Every month *Science Illustrated* is filled with new advances in vital fields...Electricity, Construction, Aviation, Atomic Energy, Radio, Synthetics, Mining, Chemistry, Electronics, Home Appliances, etc.

Science Illustrated shows you new products and designs and explains *why, when and how* they were made. Every monthly issue is packed with 30 complete, authentic articles and 140 photographs, diagrams.

ORDER NOW AND SAVE \$4!

You can order 36 big issues of *Science Illustrated* (3 full years) for ONLY \$5! This special rate saves you \$4 over the one-year price. We'll start your subscription with the big new issue now on the press—if you order within 10 days!

MAIL THIS ORDER FORM TODAY!

Science Illustrated
930 West 42nd Street, N. Y. 18, N. Y.
YES! I accept your special offer. Start my subscription to *Science Illustrated* with the new issue now on press.

- I prefer 2 yrs. at \$4 (Saves me \$2 compared with the 1-yr. rate)
 I prefer 3 yrs. at \$5 (Saves me \$4)
 I prefer 1 yr. at \$3
 Bill me later Payment enclosed

Name _____

Address _____

City _____ Zone _____ State _____

ALSO ON SALE AT ALL NEWSSTANDS 25c

EE-11-48

BETA HIGH VOLTAGE POWER SUPPLIES



PROBLEM: A prominent television component manufacturing company required a *reliable, sturdy, foolproof* power supply for breakdown testing of projection television components.

BETA Built it!

MAJOR SPECIFICATIONS

Input: 115 volts, 50/60 cycles; 75 volt-amperes.
Output: 0-45 KV, negative grounded, 100 μ a available at 40 KV. Short-circuit current limited to 500 μ a.
Safety Features: Internal interlock on cabinet door. Provision for external interlock on test apparatus.
Size: 21" x 40" x 15".
Insulation: Air insulation throughout.

Power Supplies up to 200,000 volts DC, regulated or unregulated, built to specifications. Compactness, low cost and rapid delivery featured. *Submit your high voltage power supply requirements to us for a prompt bid on price and delivery.*

Other BETA products include:

KILOVOLT METERS up to 50 KV.
 PORTABLE 0-30 KV DC POWER SUPPLIES.
 ELECTRONIC MICROAMMETERS — 0.01 μ a full-scale.

Send for descriptive literature

Field Engineers throughout the country are at your service to discuss our products more thoroughly with you.

BETA ELECTRONICS CO.
1762 Third Ave., New York 29

A B RESISTORS

Prompt Delivery From Stocks

ALL LEADING MAKES RESISTORS AND POTENTIOMETERS ERIE CAPACITORS SILVER MICA CAPACITORS

We are nationally recognized as a dependable source of supply—by the "blue chips" of the electronic industry (names on request).

We supply many Manufacturers, Universities, Research Laboratories and fill Government orders per JAN specifications.

Wire, write or telephone at once for price list. State your requirements. Courteous reply and service is guaranteed.

LEGRI S COMPANY, INC.

130 WEST 102ND STREET

NEW YORK 25, N. Y.

Telephone: ACademy 2-0019



SMALL PARTS

Filaments, anodes, supports, springs, etc. for electronic tubes. Small wire and flat metal formed parts to your prints for your assemblies. Double pointed pins. Wire straightened and cut diameter up to 1/8-inch. Any length up to 12 feet.

LUXON fishing tackle accessories. Inquiries will receive prompt attention.

ART WIRE AND STAMPING CO.

227 High St.

Newark 2, N. J.

PAMARCO DE-REELING TENSION

PAMARCO tensions are the perfect answer to lower coil winding costs!

- ★ FINGER-TIP TENSION CONTROL
- ★ OPERATOR MAKES OWN ADJUSTMENTS
- ★ NO TOOLS OR ACCESSORIES NEEDED
- ★ FITS ALL COIL WINDERS

The free-running action of the PAMARCO tension practically eliminates defective coils. Their compact size permits more simultaneous coil winds on any machine. Operator makes all adjustments for any gauge wire with simple thumbscrew.

Write Dept. E-1 for Literature Today

SHORT CUT TO
PERFECT COILS!



PAPER MACHINERY & RESEARCH, INC.
1014 OAK STREET • ROSELLE, NEW JERSEY

ELECTRONIC COUNTERS

TO MEET YOUR SPECIFICATIONS

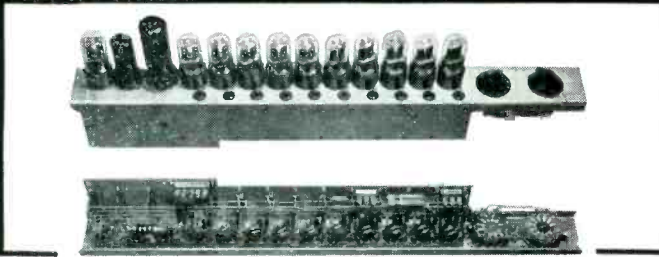

BASIC DECADE COUNTER

To meet your specifications, basic decade counters are combined with electronic switching circuits by us to provide counters and timers for factory and laboratory.

FEATURES

Over 150,000 counts per second.
Elapsed time measured to less than 7 Micro Seconds.
Decimal indication of count.
Number of decades specified.
Output signals switchable to any count.

Presetting switchable to any count.
Simultaneous inputs to two or decades.
+ or - difference counts directly indicated.
Automatic sequencing of two or more counters.

These and many other features are available at a price comparing favorably with stock counters. Send us your counting or timing problem for quotation.

Production Control Equipment Engineered and Constructed to the Customer's Satisfaction.

Technitrol Engineering Co., Inc. 3212 MARKET ST. PHILA. 4, PENNA.

Over 1000 Sizes

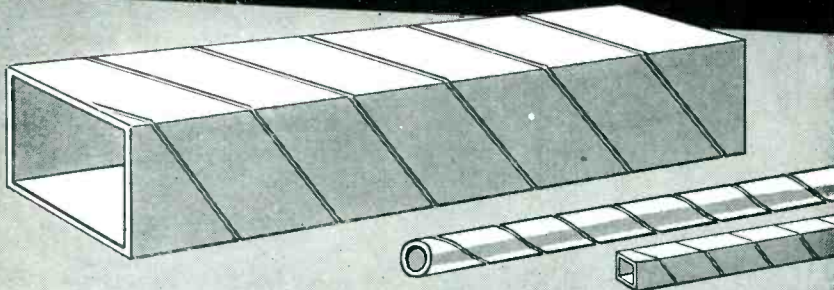

PARAMOUNT SPIRAL WOUND PAPER TUBES

Square • Rectangular • Triangular
Round and Half-Round

With a wide range of stock arbors... plus the specialized ability to engineer special tubes... PARAMOUNT can produce the exact shape and size you need for coil forms or other uses. *Hi-Dielectric*, *Hi-Strength*, Kraft, Fish Paper, Red Rope, or any combination, wound on automatic machines. Tolerances plus or minus .002". Made to your specifications or engineered for YOU.

Inside Perimeters from .592" to 19.0"

SEND FOR ARBOR LIST OF OVER 1000 SIZES

Convenient, helpful listing of over 1000 stock arbors. Includes many odd sizes of square and rectangular tubes. Write for Arbor List today. No obligation.

PARAMOUNT PAPER TUBE CORP.

616 LAFAYETTE ST., FORT WAYNE 2, IND.

Manufacturers of Paper Tubing for the Electrical Industry

BACKTALK

(continued)

indeed, come to pass. That is, a commercial service whose benefit from the use of the spectrum is the saving of money or making of a profit, due to the use of radio, logically would invest in communication equipment more rapidly than a safety service, such as city fire departments, where the obtaining of equipment is dependent upon the approval of tax-supported budgets by the local citizens. Further, the comparative frequency loading, from a traffic-handling standpoint, by two such services can represent a wide range of extremes. Aside from routine testing of radio equipment, a fire department might have very few messages to pass for protracted periods of time, depending upon the number of fires which occur.

Would it be feasible to allow taxicabs to employ fire station frequencies during periods when there is no fire? Obviously not, since when a fire occurs the fire frequency must be instantly available on a noninterference basis and no time could be allowed for clearing taxicabs from such frequencies. Even if it were possible to do so, the service to taxicabs on the basis of such uncertainty of frequency time would be impracticable from the point of view of the taxicabs.

The railroad example Courtney mentions was the subject of an FCC action prior to publication of his article, but his article apparently was written prior to the FCC action. I will not discuss it here because it involves a pending Commission hearing as do some of the other detailed examples. The extent to which these problems would be solved by the FCC proposals may be judged by each person concerned after inspection of the public announcements in Dockets 8965, 8972, 8973, and 8974.

Monitoring is a tool but it is not sufficient. Nor is the so called "need" a sufficient tool. Presumably any one who requests the use of radio can demonstrate a "need" and even "frequency requirements." As to whether these requirements can be satisfied by an allocation depends just as much upon the relative importance of other services as upon the needs of the service requesting the allocation.

The main theme of Courtney's

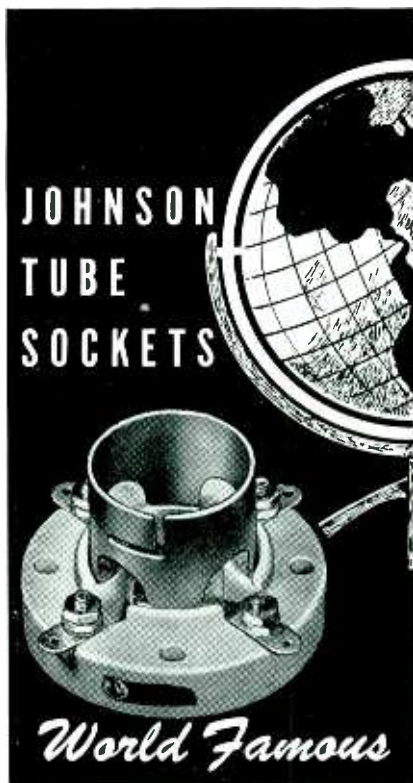

Thoughtful design, superb workmanship and top quality materials are combined in the manufacture of JOHNSON sockets to earn for them the reputation as the world's finest.

Illustrated above is the JOHNSON 123-209, a 4 pin bayonet type socket for medium power tubes having a medium 4 pin bayonet base, such as the 866.

Also available is the 123-210, a similar JOHNSON socket that fits the same tubes as the 123-209 but which is slightly smaller in size.

The 123-211 is a larger 4 pin socket for tubes such as the 872.

The 123-216 is for tubes having a GIANT 5 pin bayonet base such as the 803 and RK28.

These high quality JOHNSON tube sockets, which represent only a part of the extensive JOHNSON tube socket line, are available in porcelain or steatite.

See them at your dealers or write for latest catalog.



BACKTALK

(continued)

article deals with the dual jurisdiction in the United States over the radio spectrum. Let us examine this question from the standpoint of our philosophy of government, and more particularly from the standpoint of what can be done about the situation. The present jurisdiction is contained in the Communications Act of 1934, but the plan now in force also was contained in the preceding law, the Radio Act of 1927, which was superseded by the Act of 1934. The system has, in fact, been followed since 1922. The existing legislation provides that the FCC may assign frequencies to non-federal stations throughout the radio spectrum. There is no restriction on the Commission's authority in this respect. The very same legislation provides, however, that the President assigns frequencies to federal government stations. Here again, there is no limit or restriction of any kind on the President's authority. Moreover, and this is the interesting point, there is no procedure established in the legislation which provides for a reconciliation of conflicts between assignments made by the FCC and those made by the President. The legislation is silent on this point, except for a "time sharing" section which is not applicable in all cases. It is doubtful the courts would be in a position to resolve conflicts of this kind since it would be necessary to such a court's decision to evaluate the determinations made by the President and by the Commission. Fear of a court reversal might cast a shadow upon the investment of substantial sums in given bands of frequencies.

Next, we recall that the President has no authority over the FCC in matters of substance. The President appoints the Commissioners subject to ratification by the Senate but he does not have authority to direct, control, or veto actions of the Commission, nor can the Commission direct the President. In practice, the President has delegated his authority, under Section 305 of the Communications Act of 1934, in the matter of assignment of frequencies to government radio stations, to the Interdepartment Radio Advisory Committee. This is a voluntary committee composed

JUST PUBLISHED!

FREQUENCY MODULATION

FUNDAMENTALS • APPARATUS SERVICING

By **Nathan Marchand**
Radio and Electrical Consultant, Lecturer on Electrical Engineering, Columbia University
448 pages, 6x9, over 100 illustrations, \$3.00

MHB
A modern guide to one of radio's fastest-growing developments

SIMPLIFIES SERVICE — ENGINEERING PROBLEMS!

It takes more than ordinary radio servicing knowledge to handle the complicated special problems and methods of modern FM work! This new book by a well known radio and electrical consultant has been specifically written, first to help you understand FM clearly and, second, to explain fully just how to go about handling FM work.

With a minimum of mathematics, but with a copious use of easily understood illustrations, schematic diagrams and practical on-the-job examples, it covers the complete field of frequency modulation. Basic theory, circuits, transmitters, receivers and mobile equipment are fully explained — and special emphasis is placed on up-to-the-minute methods of installing, adjusting and repairing FM receivers.

Here at your fingertips you have everything necessary for a complete understanding of the subject — from circuit peculiarities, tuning indicators, to antennas, mobile equipment, FM test units, receiver alignment, general servicing procedure, and a host of other essential subjects. Particular attention is paid to outlining the important points of difference between FM and ordinary AM work.

Here's What It Includes

1. Fundamentals of Modulation.
2. Fidelity of Band Width Requirements
3. Noise and Interference
4. Direct Frequency Modulation
5. Frequency Control Circuits
6. Direct FM Transmitters
7. Phase to Frequency Modulation
8. FM Transmitters Using Phase Modulation
9. FM Detectors
10. Amplitude Limiters
11. RF Amplifiers, Oscillators, and Converters
12. Intermediate Frequency and Audio Circuits
13. FM Receivers
14. FM Transmitting Antennas
15. FM Receiving Antennas
16. Mobile FM Equipment
17. FM Servicing
18. Phasor Calculations, etc.

READ IT AT OUR RISK!

We're so sure you'll want to keep this new FREQUENCY MODULATION book for day to day study and reference, that we'll gladly send it to you for 10 days' examination. Read it carefully. See how quickly it brings you up-to-date on developments in this fast-growing field. Then decide whether or not you want to buy it or return it. We'll take the risk! Send no money, just mail the coupon now.

10 DAY TRIAL COUPON

Dept. E-118, Murray Hill Books, Inc.
232 Madison Ave., New York 16, N. Y.

Send me Marchand's FREQUENCY MODULATION for 10 days' examination on approval. In 10 days I will send \$5, plus a few cents postage, or return book postpaid. Postage paid on cash orders; same return privilege. (Books sent on approval in U. S. only. Price outside U. S. \$5.50 postpaid.)

Name

Address

City, Zone, State

Occupation

NOW FOR TELEVISION RECEIVERS

Carter

**SUPER CONVERTERS
WITH
PICTURE CONTROL**

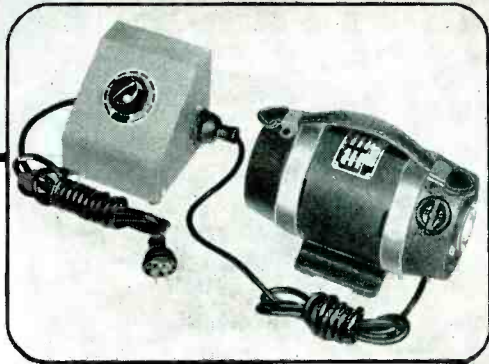

The Ideal DC to AC Portable Power Supply for Popular 7" Television Receivers

Now you can operate TELEVISION in DIRECT CURRENT districts, with perfect picture reception. Simply plug in Carter Super Converter, connect your receiver, and tune in! Exclusive Carter "Picture Control" assures clear reception, without drift, wave, or flutter. Converter AC output requires NO FILTER. Operates on 110 to 135 v. DC. Model D1010CT operates 7" receivers up to 125 watts load. Compact, lightweight.

GET NEW BULLETIN, INFORMATION, PRICES

Special TELEVISION CONVERTER BULLETIN #948 just off the press. Gives complete information, pictures, prices. Sent FREE by return mail. WRITE TODAY.



2646 N. MAPLEWOOD AVENUE

CABLE: GENEMOTOR

BACKTALK

(continued)

of those agencies operating government radio stations. The Commission obviously cannot deal directly with the President on each frequency assignment since there are thousands of such assignments every year. Even on basic matters of frequency allocations it would be safe to assume that the President would seek the advice of his cabinet officers in those Departments which operate government radio stations. The views of such cabinet officers would be the same as those expressed by the same departments in the IRAC. Since there are differences of opinion on many problems solely as between the government agencies using radio, the President presumably would seek a compromise in each such problem.

To the extent IRAC can (and has for over 25 years) arrived at such equitable compromises on a voluntary basis it would be unlikely that the President would arrive at decisions drastically different from those arrived at voluntarily by the IRAC. In any case, his own independent decision most probably would represent a point of view different from that arrived at by 4 or more of the 7 Commissioners of the FCC. This is a thoroughly reasonable assumption since the 7 Commissioners seldom are unanimous on such matters as frequency allocations. Considering the President as an eighth individual, and recognizing that he would be motivated by reasons different from those that motivate the Commission (because the President would base his decision upon the views of the government agencies whereas the Commission would base its thinking upon the cases presented by the public to the Commission), there might still be an area of disagreement or difference of opinion as between the Commission and the President. A deadlock would mean that no frequency could be assigned anyone until a decision was made. The possibilities exist of requesting Congress to resolve any dispute which might arise, or of direct negotiations between the President and the Commission, or, as is presently done, by arrangements between the IRAC, and the representative of the President, and the Commission.

This explanation is a little clearer

HEAT RESISTANT WIRES FOR EVERY APPLICATION . . .

DESIGN ENGINEERS . . .

*Do those new circuit designs
present new wire problems?*

Then check with Lewis Engineering for an economic solution and fast delivery. For twenty years we've successfully been solving the heat and age resistance wire problems of industry. We don't stock wire—we make it to your specs—for an experimental run or for the production line. If you're designing in the electronic, electrical or appliance field . . .

- HEATING UNITS
- HEATING ELEMENTS
- RESISTANCE
LINE CORD
- THERMOCOUPLE WIRE
- ASBESTOS LEAD
& FIXTURE WIRE
- INSULATED
RESISTANCE WIRE
- FIBERGLAS
INSULATED WIRE
- WIRE TO ANY
SPECIFICATIONS

Let Lewis Build The Wire For You

Send your electronic control, communications or appliance wiring specifications for a recommended solution by our engineers.
FOR A TRIAL ORDER OR A CARLOAD consult



THE LEWIS ENGINEERING CO.

Wire Division
NAUGATUCK CONNECTICUT

For Originality

LOOK TO 

ZIP! THE SIZE YOU WANT in a Flash!

If you do nut driving, better ask your dealer about this set! Seven most needed sizes with color coded XCELITE handles to flash you the size! Top grade tool steel blades—new, larger, more comfortable handles. Sturdy, lockable metal holder. A real time saver!

XCELITE
No. 127
Super Delux
Nut Driver Set



"ANOTHER XCELITE FIRST"
PARK METALWARE CO., INC.
Dept. C Orchard Park, N. Y.

Quality Tools **PREFERRED BY EXPERTS**
FIRST TO USE PLASTIC FOR SCREWDRIVER HANDLES

Manufacturers of Quality Capacitors—Oil and Wax
Fabricated Plate ELECTROLYTICS

- ★ RADIO
- ★ TELEVISION
- ★ MOTOR STARTERS
- ★ AUTOMOTIVE
- ★ ELECTRONICS
- ★ POWER FACTOR CORRECTION

Your Specifications for Quotation will be given
Prompt Attention

CHICAGO CONDENSER CORPORATION
3255 WEST ARMITAGE AVENUE CHICAGO 47, ILLINOIS

*Send For This Valuable
Mailing List Data!*

To aid you in planning your direct mail, check any of these mailing lists you may be interested in . . .

- Business Executives
- Electrical Appliance Dealers
- Manufacturing Industries
- Metal-Working Industries
- Aviation Industries
- Bus Industry
- Chemical Processing Industries
- Civil Engineering and Construction Industries
- Coal Mining Industries
- Electrical Industries
- Electronic Engineers
- Food Industries
- Metal Mining Industries
- Power Plant Engineers
- Product Design Engineers
- Textile Industries
- Welding Industry

. . . attach this 'ad' to your business letterhead . . . and mail. We'll send you complete information, selections, list counts, and prices. No obligation, of course.

Direct Mail Division

**McGRAW-HILL
Publishing Company**
330 W. 42nd St., New York 18

**DEVELOPMENT
ENGINEER**

Communications Engineer or Physicist with a minimum of ten years' electronic development experience wanted for circuit development work on commercial test equipment.

Excellent opportunity for permanent employment in congenial surroundings with good working conditions.

All replies held in confidence. Please submit complete resume directly to

Dr. G. A. Downsbrough

**BOONTON
RADIO CORPORATION**
BOONTON, NEW JERSEY

**COIL
WINDING
MACHINES**

We manufacture machines to wind all types of coils on a laboratory or production basis.

also

- Assembly Fixtures
- Miniature Tube Pin Straighteners
- Dummy Tubes
- Tube Pullers

Production Equipment Co.

37 West Main St.

Oyster Bay, Long Island,
New York

Phone Oyster Bay 6-0009

FREE! send for our
RADIO BUYING GUIDE
a complete and diversified line-up of:

- electronic equipment
- sound systems
- recording equipment
- amateur gear
- television components and kits
- replacement parts
- laboratory and service test equipment

Save time and money—buy direct from distributor! Consult the NEWARK radio buying guide, featuring all standard makes . . . a value-packed listing of 20,000 essentials for expert servicemen, engineers, soundmen, experimenters, teachers, hobbyists, amateurs!

24 HOUR SERVICE ON ALL ORDERS
Free technical advisory service!

JUST MAIL THIS COUPON TO GET YOUR CATALOGUE
Newark Electric Co., Inc., Dept. 8
242 West 55th St., New York 19
Please send me the FREE Newark Buying Guide of fine radio equipment.

Name _____
Address _____
City _____ State _____



3 GREAT STORES
115 W. 45th St., & 212 Fulton St., NEW YORK
and 323 West Madison Street in CHICAGO

MAIL ORDER DIVISIONS
242 West 55th Street, NEW YORK 19, N. Y.
323 West Madison Street, CHICAGO 6, ILL.

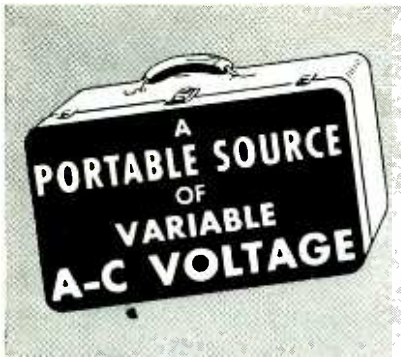

VOLTBOX A-C POWER SUPPLY

- COMPACT
- PORTABLE
- HANDY

Operation of the Superior Electric VOLTBOX is simple. Plug into 50/60 cycle single phase source, snap "ON-OFF" switch to "ON". Snap "LINE-LOAD" switch to "LOAD", rotate knob to produce continuously adjustable output voltage, from 0 to 17 per cent above line voltage. Read line voltage by snapping "LINE-LOAD" switch to "LINE".



TYPE
UC1M

INPUT: 115 volts, 50/60 cycle,
single phase
OUTPUT: 0-135 volts, 7.5 amperes,
1000 VA

Type UC2M available for 230 volt operation.

ALL THIS IN ONE PORTABLE PACKAGE

Cast aluminum case • POWER-STAT variable transformer • Easy-to-read voltmeter • Superior 5-Way Binding Posts • Output receptacles • "ON-OFF" switch • "LINE-LOAD" switch • Renewable fuse for overload protection • Six foot cord-plug.

FOR FULL DETAILS WRITE

THE
**SUPERIOR ELECTRIC
COMPANY**
411 MEADOW STREET
BRISTOL, CONN.



BACKTALK

(continued)

than the actual situation which Courtney describes. Up to this point neither Courtney's article nor this letter has examined the reasons behind this most peculiar situation. An understanding of these reasons is fundamental to the drafting of a plan for improvement. The reasons are briefly these. The military, that is the Army, Navy, and the Air Force, probably would not wish to apply to an independent civilian board or commission for frequencies to be used for the national defense. Presumably, the President, as Commander-in-Chief, could direct the military to do just that but it is an unlikely situation and one which will certainly not come to pass at a time when the country is arming for defense. As long as there is a requirement to maintain the Armed Forces in peacetime, it is unlikely that the President and the Congress would allow a non-military agency to parcel out frequencies to be used for military purposes. This is the situation that appears to exist. Only to the extent it is fallacious can this factor be ignored.

Next, it certainly can be stated that the public, in peacetime, would not wish its frequencies to be parceled out by the Armed Forces. Here again is an assumption based upon our way of life, and only to the extent that this assumption is invalid could this factor be ignored. The source of the federal authority to regulate the use of the radio spectrum is recognized by all to be the Congress, and the so-called dual jurisdiction over the radio spectrum could be eliminated only by new legislation. The 1927 Act and the 1934 Act obviously intended a dual jurisdiction and the final report of the Select Committee of the House of Representatives (H.Res. 21—78th Congress) which reviewed this point in detail in 1943-4 stated in part: "The broad division of jurisdiction seems to be a logical one."

One might suggest that appropriate military authorities be made Commissioners ex officio, at least to the extent of having veto power over actions of the Commission which might affect military frequencies. A little thought will reveal weakness in such a plan. The position taken by such military

NEW! CORONA-FREE RF FILAMENT TRANSFORMERS FOR TELEVISION AND NUCLEAR RESEARCH



Now, a HI-VOLTAGE, CORONA SHIELDED, TUNED TRANSFORMER ASSEMBLY which includes an octal socket for use with 1B3-8016 type tube.

Filament voltage is easily adjustable through a small access hole in bottom of spun copper cup, allowing tube to be used for voltages from 1KV to 20KV.

TYPICAL 10KV CIRCUIT SHOWING USE OF CORONA-FREE RF FILAMENT TRANSFORMER

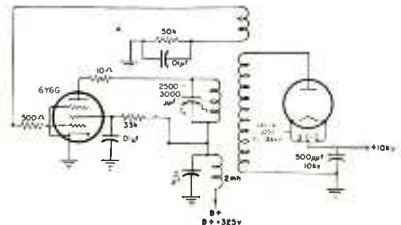

This unit is designed to operate in conjunction with RF step-up coils of approximately 200 KC frequency, solving the problem of research workers and experimenters in the construction of CORONA-FREE HIGH VOLTAGE RF POWER SUPPLIES. Ideal for use with our 10KV coil. To obtain 20, 30, 40 KV—or higher voltages—merely use doubler, tripler or quadrupler circuits. To obtain still higher voltage, additional cascade units can be added.

These Corona-Free RF Filament Transformer Units are provided with diagrams and instructions.

A PRECISION-MADE PRODUCT
ACTUALLY PRE-TESTED IN CIRCUITS
Net Price—No. V055 . . \$5.50
Also Available With A Tested 1B3 Type Tube
Complete With Plate Cap.

Net Price—No. V056 . . \$7.65
AVAILABLE FOR IMMEDIATE DELIVERY!

LIMITED QUANTITIES AVAILABLE!
HIGH-VOLTAGE COILS!
15KV—25KV—30KV
Prices sent on request. Write—phone today
for yours!

Include 25% Deposit With Order,
Balance C.O.D.

Pioneers in Projection Television
SPELLMAN TELEVISION CO., INC.
130 WEST 24th STREET • NEW YORK 11, N. Y.

For the finest
WIRED MUSIC
The utmost fidelity in
STUDIO MONITORS
The highest quality
PUBLIC ADDRESS

Graham
Audio Amplifiers

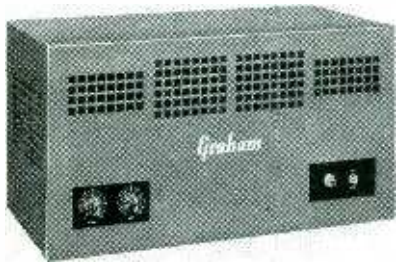

Graham Model 200-A

POWER OUTPUT: 20 watts
FREQUENCY RESPONSE: Within ± 1 db, 30 to 15,000 cycles
MAXIMUM GAIN: 62 db
NOISE: 79 db below full output unweighted
INPUT IMPEDANCES: 150,000 ohms. Also bridging
OUTPUT IMPEDANCES: 125,500, 4 ohms
DISTORTION:
At +43 VU, Less than 2%, 50 to 10,000 cycles
Less than 3%, 50 to 15,000 cycles
POWER: 105-125 volts, 50/60 cycles, 140 VA.



Graham Model 180-A

Specifications same as 200-A with these exceptions:
POWER OUTPUT: 8 watts
NOISE: 73 db below full output unweighted
DISTORTION: At +39 VU. Same as Model 200-A.
POWER: 105-125 volts, 50/60 cycles, 110 VA.

Other input and output impedances optional on either model. Preamplifiers available for low and high impedance microphones or pickups.

- Precision-engineered to the exacting standards required for wired-music services, broadcast station monitors and top-quality public address systems.

- Input transformers may be operated directly from telephone lines (local telephone practice permitting), eliminating the necessity of using re-peat coils.

- Generous interleaving of the output transformers results in reduced leakage reactance, permitting excellent wave form up to highest frequencies at full power.

- Thorough testing at each stage of manufacture, from raw material to finished product, assures rigid adherence to specified characteristics, and long life.

Write for further details

GRAHAM DIVISION
of the
ACRO TRANSFORMER MFG. CO.
21-20 33rd AVE., L. I. CITY 2, N. Y.

BACKTALK

(continued)

Commissioners necessarily would be based upon advice received from the Armed Forces. By the time such military Commissioners stated their positions, matters would have progressed to the point where the possibility of negotiation, adjustment and equitable compromises would be minimized or eliminated. This would be true whether such a system was tried under the existing legislation or a new agency was given exclusive authority over the spectrum. The net result would lead in the direction of deadlock.

The present system has, in fact, worked for more than a quarter of a century. In the end, the fundamental consideration of utilizing the radio spectrum for the greatest good of the greatest number will govern the allocations to the several services. If the military chooses to use too large a percentage of the spectrum in peacetime, to the actual detriment of public uses of radio, then certainly the President or Congress will make the necessary curtailment in such military uses of radio consistent with the national interest. If, on the other hand, the civilian agency allocating the frequencies to the non-government services fails to take sufficiently into account the requirements of the military for frequencies for the National Defense, then that agency can expect a Congressional overhauling.

We do not have adequate publicity as to the importance of frequencies used by government agencies as compared to the importance publicly acclaimed for non-government uses. Nor is there any mechanism for any single agency other than the Congress to evaluate the relative public importance of Federal government uses and non-government uses. But we do know that the Congress has a direct control over the funds available for all government radio stations, and that the cost of each such station and its maintenance is "justified" in the government agency concerned, to the Bureau of the Budget, to the President, to the House, and to the Senate. Also, in recent months, the Congress has provided large sums for particular programs leading to the installation of large numbers of new government radio stations. Surely, these

**QUICK
AS AN
ELECTRONIC
WINK**

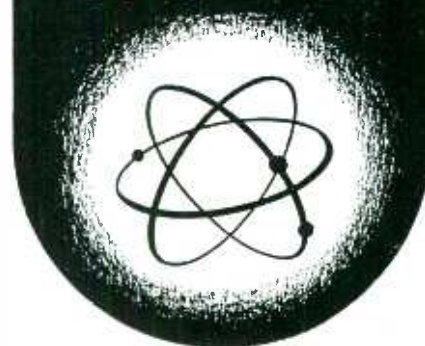

That's how fast a STABILINE Automatic Voltage Regulator corrects line voltage fluctuations. Type IE (Instantaneous Electronic) has no moving parts — is completely electronic in operation. Designed to act instantaneously — with a waveform distortion not exceeding 3 percent — and to keep output voltages stable within ± 0.1 of 1 percent of the preset value, regardless of line variations. For any load current change or load power factor change from lagging .5 to leading .9, the STABILINE Type IE will hold the output to within ± 0.15 volts of nominal. Various models available in numerous ratings.



Rear View
STABILINE Type IE

Bulletin 547 gives you information on this and other Superior Electric voltage control equipment. Write for your copy today.

**THE
SUPERIOR ELECTRIC
COMPANY**
411 MEADOW STREET
BRISTOL, CONN.



S.S. White MOLDED RESISTORS

The All-Weather Resistors

ARE USED IN HIGH VOLTAGE "HIPOT" COUPLERS

S.S. White resistors are connected in series to permit a current flow to ground, when the "Hipot" Coupler is used to measure or to synchronize voltage of high voltage lines.

Canadian Line Materials, Ltd.—maker of "Hipot" Couplers and other transmission and lighting equipment—says, "We have always found S.S. White resistors of the highest quality". This checks with the experience of the many other producers of electrical and electronic equipment who use S.S. White resistors.



S.S. WHITE RESISTORS

are of particular interest to all who need resistors with *low noise level* and *good stability* in all climates.

HIGH VALUE RANGE

15 to 10,000,000 Megohms

STANDARD RANGE

1000 Ohms to 10 Megohms

WRITE FOR BULLETIN 4505

It gives details of S.S. White Resistors including construction, characteristics, dimensions, etc. Copy with price list on request.



S.S. WHITE INDUSTRIAL DIVISION

THE S. S. WHITE DENTAL MFG. CO. DEPT. R 10 EAST 40th ST., NEW YORK 16, N. Y.



FLEXIBLE SHAFTS • FLEXIBLE SHAFT TOOLS • AIRCRAFT ACCESSORIES
SMALL CUTTING AND GRINDING TOOLS • SPECIAL FORMULA RUBBERS
MOLDED RESISTORS • PLASTIC SPECIALTIES • CONTRACT PLASTICS HOLDING

COUNT TEN TIMES FASTER

...and accurately!

The new Photo-electronic Counter was designed for industrial applications in which mechanical counters do not count accurately or wear rapidly because of counting speed. One of the well-known Potter electronic counter decades is used to scale down the operating speed of a reliable electro-mechanical register. In the Model 310, the photo-electric "eye" is located inside the cabinet and the light enters through a small window at the rear. In the Model 312, the photo-electric "eye" is housed separately for remote counting. Small objects as well as closely spaced parts can be accurately counted since the width of the photo-electric beam is only 1/4 inch, and does not require complete interruption for actuation. Another version the Model 311, uses an electromagnetic pick-up coil for counting shaft rotation without contact.

For complete literature or consultation on high speed counting, timing and control problems call or write Dept. 6R.



MODEL 310
ILLUSTRATED
PRICE \$185⁰⁰

NEW POTTER PHOTO-ELECTRONIC COUNTER

- ★ High speed—counts at rates up to 6000 per minute
- ★ Long life—mechanical register operates at only 1/10 normal rate
- ★ Direct reading—units digit is read from electronic counter, other digits from mechanical counter
- ★ Accurate—mechanical register not affected by detector "on-off" time
- ★ Compact—completely self-contained, no wiring required, easy to install
- ★ Flexible—self-contained "eye", separate "eye" or electromagnetic pick-up coil may be used for actuation

POTTER INSTRUMENT COMPANY

INCORPORATED

136-56 ROOSEVELT AVENUE • FLUSHING • NEW YORK



BACKTALK

(continued)

must be in the public interest.

The government agencies other than the military which use frequencies would seem to be in a sort of neutral position in that they could receive their frequencies from the same source as the military or from the same source as the public. Treatment of this feature of the problem would not, in itself, eliminate the dual jurisdiction.

We might look briefly at the situation in the United Kingdom. The procedure followed there is remarkably similar to that used in the United States. The British Post Office functions in much the same way as the FCC, but, in addition, acts as an operating agency for some of the public radio services. The British military sit on the Wireless Telegraph Board, which is a rough counterpart of the IRAC in the United States, and the military therefore look to the British Cabinet, which contains representatives of its Army, Navy, and Air Forces as well as the Postmaster General, for the resolution of conflicts. Neither the system in the U. S. nor in the U. K. seems to have been patterned after the other. The net difference in the two systems is rather slight.

The attention of those interested in this important subject is invited to the testimony of former FCC Chairman Fly before a Select Committee of the House of Representatives (78th Congress—H. Res. 21, Part 3, page 2860) where Mr. Fly testified at length and stated in part, in regard to the IRAC: "I think it would be unwise to tamper with that successful and cooperative (IRAC) operation. I have no particular objection to spelling out the same sort of thing by legislation, but as a practical matter, I don't see how it could be improved upon."

Former Commissioner Craven, testifying before the same House Committee, expressed a somewhat different view. He said, in part:

"It seems to me that Congress could settle this matter by specifying in the law more clearly the various jurisdictions and what procedures shall be adopted in reconciling conflicts with respect to the use of the radio frequency spectrum, as between the Government departments, on the one hand, and private enterprise on the other.

I would suggest that first the President be empowered in the act to appoint an Interdepartment Radio Advisory Committee having much the same functions, powers, and department representation as

PROFESSIONAL SERVICES

Consulting — Patents — Design — Development — Measurements

in

Radio, Audio, Industrial Electronic Appliances

THE BARRY CORPORATION

Specialists in the Control of
VIBRATION IMPACT NOISE
*Engineering Development
Manufacturing*
179 Sidney Street Cambridge, Mass.
Telephones: ELIot 0861-0140

ERCO RADIO LABORATORIES, INC.

Radio Communications Equipment
Engineering - Design - Development - Production
Pioneers in Frequency Shift Telegraph
Garden City • Long Island • New York

MEASUREMENT ENGINEERING LIMITED

Consultants on Special Equipment for measurements and production tests, communications and audio systems.
Arnprior, Ont. 2235 Addington Ave.
61 Duke St. Toronto, Ont. Montreal, Que.

H. RUSSELL BROWNELL

Consultant
Specializing in Measurements & Testing
Instruments & Techniques - Electrical - Electronic - Magnetic
188 West 4th St. New York 14, N. Y.
Chelsea 2-4208

FRANKEL & NELSON

Consultants in Mathematical Physics
7716 Firenze Ave. Los Angeles 46, Calif.
Granite 6870

Eugene Mittelman, E.E., Ph.D.

Consulting Engineer & Physicist
High Frequency Heating — Industrial Electronics
Applied Physics and Mathematics
549 W. Washington Blvd. Chicago 6, Ill.
State 2-8021

CANOGA CORPORATION

Electronic Engineers
Radar, Pulse Techniques, MTI Systems, Pulse and Television Receivers, Video Amplifiers, Test Equipment, Microwave Antenna Applications, Electronic Controls, and Microwave Equipment.
SHOP AND LABORATORY FACILITIES
14315 Bessemer St. Van Nuys, Calif.
STate 5-9722

GENERAL INSTRUMENT & ENGINEERING

CONSULTATION RESEARCH DEVELOPMENT
IN
ELECTRONICS, E. E., PHYSICS
100 Barr Building Washington 6, D. C.

ALBERT PREISMAN

Consulting Engineer
Television, Pulse Techniques, Video Amplifiers, Phasing Networks, Industrial Appliances
Affiliated with
MANAGEMENT-TRAINING ASSOCIATES
3808-14th St., N.W. Washington 10, D. C.

EDGERTON, GERMESHAUSEN & GRIER, Inc.

Consulting Engineers
Research, Development and Manufacture
of Electronic and Stroboscopic Equipment
Specialists in High-Speed Photography
155 Massachusetts Avenue, Cambridge 39, Mass.

GLOBE PRODUCTS CORPORATION

Electronic Division
Specializing in Test Methods and Techniques—
Development and Design of Electronic Test and
Measurement Equipment—Automatic and Manual
—Production and Laboratory types.
870 Maplewood Ave.
P.O. Box #7 Bridgeport, Conn.

RADIO ENGINEERING COMPANY

Design and Development
R.F. IF, Osc. Coils Stable Oscillator Circuits
Test Equipment Instrumentation
Measurements Frequency Calibration
F.M.-A.M. Receivers—High Fidelity Audio Systems
COMPLETE LABORATORY FACILITIES
8 State Street, New York 4, N. Y. Whitehall 4-5266

ELECTRO IMPULSE LABORATORY

Consulting Physicists
Radio Interference and Noise Meters; Interference
Suppression Methods for Ignition Systems and
Electrical Devices.
P. O. Box 250 Red Bank, New Jersey
Red Bank 6-4247

PAUL GODLEY CO.

Consulting Radio Engineers
GREAT NOTCH, N. J.
Est. 1926 Little Falls 4-1000

A. F. SMUCKLER & CO.

Electronic Engineers
Electronic Product Manufacturing
Contractors to United States Government
238-346 East 23rd St. New York 10, N. Y.
GRamercy 5-8151

ELECTRO-MECHANICAL RESEARCH INC.

Specialized Research and Manufacture
High and Low Frequency Circuit Development
Electronic Measuring and Test Equipment
Optical and Infra-Red Studies
Special Geophysical Equipment
Magnetic Susceptibility Meters
Ridgefield, Conn.

HANSON-GORRILL-BRIAN INC.

Product & Mfg. Development
ELECTRICAL - ELECTRONIC
HYDRAULIC - MECHANICAL
One Continental Hill Glen Cove, N. Y.
Glen Cove 1922

SPECTRUM ENGINEERS

Electronic & Mechanical Designers
540 North 63rd St., Philadelphia 31, Pennsylvania
GRanite 2-2333; 2-8135

ELECTRONIC ENGINEERING CO. of CALIFORNIA

Radio and Electronic Consulting and
Designing.
2008 W. Seventh St. Los Angeles
DRexel 8323 California

LERU LABORATORIES, INC.

Design and Development of Electronic Equip-
ment for industrial and scientific purposes
Special experience in microwaves, spectrum ana-
lyzers, photo-electric circuits, test equipment, etc.
360 Bleeker Street
New York 14 WAtkins 9-4194

TELEREGISTER LABORATORIES

Development — Design
Studies and Investigation
Automatic Data Handling Storage
Digital Computers
Coded Pulse Techniques
157 Chambers Street New York City
DiGby 9-4440

THE
REAL
VALUE

of placing your unusual problem in the hands of a competent consultant is that it eliminates the elements of chance and uncertainty from the problem and provides real facts upon which to base decisions.

Microwave Transmission Problems

are a cinch with

Waveflex Waveguides



The WAVEFLEX waveguide incorporates *all* of the advantages of rigid waveguides while offering the additional feature of flexibility. Designers of radar, FM, and television transmission equipment have discovered that this combination of properties simplifies many of their design problems.

WAVEFLEX waveguides offer lower attenuation loss, excellent impedance match, and extreme flexibility without loss of efficiency. They are made in ac-

cordance with joint Army-Navy specifications. Let us work with you in developing special waveguides for your special applications.

Literature on request
TITEFLEX, INC.
410 Frelinghuysen Ave., Newark 5, N. J.



BACKTALK

(continued)

that body has today. This would legalize in every respect such a radio frequency coordinating agency for the Government departments.

I likewise suggest that in all matters having to do with broad policies of radio frequency allocation, the President be authorized to consider independent recommendations from both the Interdepartment Radio Advisory Committee and the Federal Communications Commission. In the event of differences between these two agencies, the President should be authorized to appoint a special Radio Advisory Board, such as I mentioned this morning, comprised of the Secretary of State, other Cabinet members, selected members of the Interstate and Foreign Commerce Committee of the House, and the Interstate Commerce Committee of the Senate, and perhaps private citizens. The latter I would choose on the basis of their well-known leadership in matters having to do with the social, economic, and scientific aspects of radio, and their broadness of vision, men who would have the confidence of the public. I think it will become increasingly important that these matters be determined on a broader scale than they are now."

The significance in Mr. Craven's statement seems to be that the President apparently would be the final authority, but that the FCC and IRAC both would be continued. Whether such a system would prove too cumbersome in practice would be subject to test; but it would not seem to lend itself to prompt, decisive actions.

A. L. McINTOSH, *Chief
Frequency Allocation & Treaty Div.
Federal Communications Commission
Washington, D. C.*

MANUFACTURE of piezoelectric quartz crystals identical to natural quartz seems possible in the near future. Early in this century Giorgio Spazia in Italy grew quartz crystals at rates of an inch a year. During the recent war Richard Nacken, a German geologist, obtained somewhat higher rates. This August, Ernest Buehler and A. C. Walker of the Bell Telephone Labs described a method before the International Union of Crystallography at Harvard University whereby rates of growth in excess of an inch a month are obtained under conditions suitable for quantity production; faster rates can be obtained under laboratory conditions. The method consists of placing finely powdered silica and an aqueous alkaline solution in a steel bomb at the top of which is suspended a seed plate of quartz. The bomb is sealed and placed in a furnace. Under pressures exceeding 15,000 pounds per square inch and at temperatures of about 750 F, silica dissolves, rises to the cooler portion of the bomb and deposits atom by atom on the seed plate producing a large clear quartz crystal from which filter and oscillator plates can later be cut.

Quality you can see!

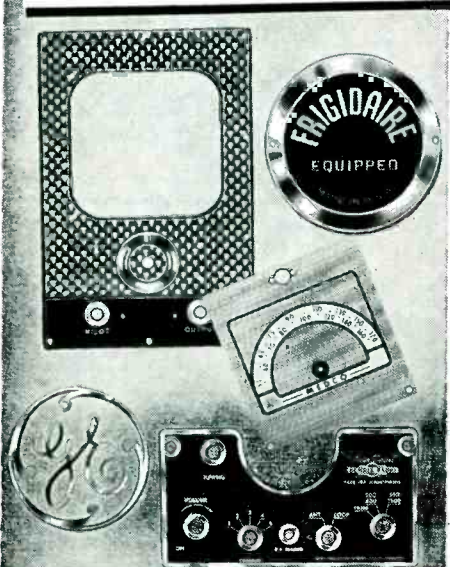

PREMIER DIALS, PANELS & PLATES

What counts, sales-wise, is what your customer sees. What gets the attention for Premier Metal Products, quality-wise, is their sharpness and clarity . . . close tolerances . . . rich colors and baked-in finishes. Let us tell you how these qualities can add important sales-appeal to your products.

Etched & Lithographed on:

- Aluminum
- Bronze
- Monel
- Brass
- Copper
- Nickel Silver
- Stainless Steel

WRITE FOR BULLETIN

PREMIER METAL ETCHING COMPANY
21-07 44TH AVENUE LONG ISLAND CITY 1, N. Y.

Quality Products for Over 35 Years

CONTACTS

FOR THE FIELD OF ELECTRONICS

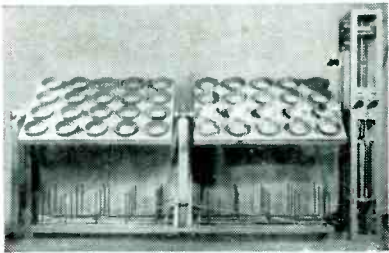

TILTING TABLES for C. R. Tubes

For settling, decanting and drying C. R. Tubes. Manual or automatic timing. Standard or Special Design for any tube size.

ALSO Special equipment of any type—mechanical; electrical; electronic.

BUCK ENGINEERING CO., INC.

37-41 Marcy St. Freehold, N. J.

MICROMETER FREQUENCY METER

for Checking Transmitters from 100 Kc to 175 Mc within 0.01 per cent

LAMPKIN LABORATORIES, INC.
Bradenton, Fla., U. S. A.

FLUXES

SOLDERING - BRAZING & WELDING

L. B. ALLEN CO. INC. Chicago 31, Ill.
6751 BRYN MAWR AVE.

This CONTACTS Section

supplements other advertising in this issue with these additional announcements of products essential to efficient and economical production and maintenance. Make a habit of checking this page, each issue.

Classified Advertising Division
ELECTRONICS

ELECTRON TUBE MACHINERY OF ALL TYPES

STANDARD AND SPECIAL DESIGN

.....
We specialize in Equipment and Methods for the manufacture of

- RADIO TUBES
- CATHODE RAY TUBES
- FLUORESCENT LAMPS
- INCANDESCENT LAMPS
- NEON TUBES
- PHOTO CELLS
- X-RAY TUBES
- GLASS PRODUCTS

Production or Laboratory Basis

.....
Kahle ENGINEERING CO.
1309 SEVENTH STREET
NORTH BERGEN, N. J., U. S. A.

FINE RIBBONS OF TUNGSTEN and MOLYBDENUM

Quality and accuracy in our fabrication of Tungsten & Molybdenum Ribbons have characterized our service to the Electronic industry.

A development of
H. CROSS Co.
15 Beekman St., New York 7, N.Y.

STRIP WIRE FASTER with Speedex Wire Stripper

STRIPS 300 OHM TWIN TELEVISION LINE OR ANY SINGLE OR DOUBLE WIRES - MODELS FOR ALL SIZES.

The Ideal Wire Stripping Tool for Craftsmen; Radio, Maintenance, Auto Ignition Men; Electricians; Manufacturers.

Fast, easy to use. SPEEDEX strips all types of solid and stranded wires. Models for every purpose. Use on job, or in production wiring—FAST—strips 750-1,000 wires per hour, makes anyone an expert wire stripper. Hardened Steel cutting blade, interchangeable. Regular Model No. 733 strips No. 12 to No. 20 wires. ORDER TODAY or write for literature.

\$3.60 NET

GENERAL CEMENT MFG. CO., ROCKFORD, ILL., U.S.A.

WE manufacture a complete line of equipment

<p>SPOT WELDERS, electric from ¼ to 50 KVA TRANSFORMERS, special and standard types INCANDESCENT LAMP manufacturing equipment FLUORESCENT TUBE MAKING EQUIPMENT ELECTRONIC EQUIPMENT, vacuum pumps, etc. WET GLASS SLICING and cutting machines for laboratory use GENERAL GLASS working machines and burners COLLEGE GLASS WORKING units for students and laboratory</p>	<p>AC ARC WELDERS from 100 to 400 Amps</p>
---	--

EISLER ENGINEERING CO.
731 So. 13th St. (near Avon Ave.) Newark, New Jersey

Antenna Coils, Grid Clips, Dial Cord Springs and Precision Springs of all types pertaining to RADIO and TELEVISION.

Your inquiries invited

WEBSTER SPRING CORPORATION
97 South 5th Street Brooklyn 11, New York

ELECTRO ENGINEERING WORKS

6021 COLLEGE AVENUE - OAKLAND 18, CALIFORNIA

Specializing in High Voltage Filament and Plate Transformers for Electronic Projects
Prompt Deliveries

LOCKING TYPE TUBE CLAMPS

Stainless Steel

Send for Illustrated catalog and engineering data
THE GEORGE S. THOMPSON CORPORATION
South Pasadena, California

BALL BEARINGS

MPB makes more than **40** different types and sizes . . .

For precision instruments, laboratory equipment, electronic devices, to minimize friction, space, weight, and to overcome starting torque specify MPB bearings.

Radial · Pivot · Angular Contact · Thrust
Promptly Available · Ask for catalog EL-2

MPB MINIATURE Precision BEARINGS
INCORPORATED
KEENE, NEW HAMPSHIRE, U.S.A.



INVESTIGATE THIS OPPORTUNITY

To join the staff of one of the largest research organizations in the country devoted exclusively to

VACUUM TUBE RESEARCH

Working conditions are ideal in these laboratories which are located in the New York Suburb of Orange, New Jersey. Your associates will include men of many years experience in vacuum tube research and development.

This rapidly expanding organization is devoted to both commercial and military research. It is a division of one of the oldest vacuum tube manufacturers in America. Security and stability for the years to come are assured. You will have an opportunity to gain experience with the different kinds of vacuum tubes, receiving, power, cathode ray, sub-miniature, micro-wave, radial beam and various special types.

If you can qualify as a

**PHYSICIST • MATHEMATICIAN • ELECTRICAL ENGINEER
CIRCUIT TECHNICIAN • VACUUM TUBE TECHNICIAN**

write at once to

RESEARCH DIVISION

NATIONAL UNION RADIO CORPORATION

350 SCOTLAND RD.

ORANGE, NEW JERSEY

TELEVISION ENGINEERS

The Crosley division, Avco Manufacturing Corporation is expanding its television receiver activities on a long term basis, creating a few positions for qualified supervisory and senior engineers.

Requirements: College degrees. Three or more years' experience in television and radar design and development of which at least two years have been spent in advanced or product development of television receivers. Specialists in circuit elements will be considered.

Ideal working conditions in well equipped modern laboratories with unlimited opportunities for advancement. Forty hour week, insurance, hospitalization and pension plans. Responsibilities and excellent salaries based on experience and ability.

Replies (which will be kept confidential) stating age, experience, education and salary requirements should be addressed to:

Director of Research and Engineering
CROSLY DIVISION

AVCO MANUFACTURING CORPORATION
1329 Arlington St. Cincinnati 25, Ohio

SCIENTISTS AND ENGINEERS

Wanted for research and advanced development in the fields of microwaves, radar, gyroscopes, servomechanisms, instrumentation, computers, and general electronics. Scientific or engineering degrees required. Salary commensurate with experience and ability. Direct inquiry to Manager, Engineering Personnel.

BELL AIRCRAFT CORPORATION
P. O. Box 1, Buffalo 5, New York

REPLIES (Box No.): Address to office nearest you
NEW YORK: 330 W. 42nd St. (18)
CHICAGO: 520 N. Michigan Ave. (11)
SAN FRANCISCO: 68 Post St. (4)

POSITION VACANT

TELEVISION—ENGINEERS with various degrees of training and experience required by a leading Chicago manufacturer of tuners and other television components. Reply fully in confidence giving all details, including age and salaries. Our staff is aware of these openings. P-6528, Electronics.

SELLING OPPORTUNITY OFFERED

MANUFACTURER HIGH class varnished fabric tubings wants representatives in the electronic, radio line. RW-6674, Electronics.

EMPLOYMENT SERVICES

SALARIED POSITIONS \$3,500-\$35,000. If you are considering a new connection communicate with the undersigned. We offer the original personal employment service (38 years recognized standing and reputation). The procedure, of highest ethical standards, is individualized to your personal requirements and develops overtures without initiative on your part. Your identity covered and present position protected. Send only name and address for details. E. W. Bixby Inc., 266 Dun Bldg., Buffalo 2, N. Y.

EXECUTIVES \$3,000-\$25,000. This reliable service, established 1927, is geared to needs of high grade men who seek a change of connection under conditions assuring, if employed, full protection to present position. Send name and address only for details. Personal consultation invited. Jira Thayer Jennings, Dept. E, 241 Orange St., New Haven, Conn.

POSITIONS WANTED

ASSISTANT PLANT Manager, 7 yrs. experience on incentives, simplification, layout, job evaluation. Degrees in management. PW-6481, Electronics.

RESEARCH ELECTRONICS; M.S. Physics 1947; electronics design, testing, 3 years; asst. Prof. Physics 1 year; Sigma Xi; Knowledge of nuclear processes and audio sound field; with concentrated study could qualify to do top research in other fields such as optics. PW-6621, Electronics.

PROFESSOR OF electronics and communication desires position in research or teaching, industrial experience, many papers published, advanced degree. PW-6655, Electronics.

SPECIAL SERVICE

Service Organization
New Orleans area, available to manufacturers of any Electronic apparatus on Service Agency setup. Industrial, medical and commercial radio. Write "Delta Electronics", Box 476, New Orleans 1, La.

WANTED Mathematicians, Engineers, Physicists

Men to train in oil exploration for operation of seismograph instruments, computing seismic data, and seismic surveying. Beginning salary \$250.00 to \$300.00 per month dependent on background. Excellent opportunity for advancement determined on ingenuity and ability. Nature of work requires several changes of address each year; work indoors and out; general location in oil producing locations.

To apply write giving scholastic and employment background, age, nationality, marital status, and include recent snapshot to

NATIONAL GEOPHYSICAL CO., INC.
8800 Lemmon Ave. Dallas 9, Texas

ELECTRONIC ENGINEER

An opportunity for a man with considerable experience to head a small developing and engineering group in a growing company in Chicago. Pulse experience a necessity and a background of work with nuclear radiation instrument and nuclear detectors very desirable. Please give full details.

P-6593, Electronics
520 North Michigan Ave., Chicago 11, Ill.

Positions open for PHYSICISTS SR. ELECTRONIC ENGINEERS

Familiar with Ultra High frequency and micro wave technique.

Experience with Electronic Digital and/or Analog Computer Research and Development Program. Salaries commensurate with experience and ability. Excellent opportunities for qualified personnel.

Contact:

C. G. Jones, Personnel Department,
GOODYEAR AIRCRAFT CORPORATION
Akron 15, Ohio

WANTED ELECTRICAL ENGINEER

A nationally known Chicago company is in need of a high grade, experienced electrical engineer. He must be a college graduate with a B.S. in E.E. degree, with high scholastic record. Should have from two to five years experience in electronics, preferably with a minimum of two years in the design of audio amplifiers. In reply give all particulars and state expected salary.

P-6750, Electronics
520 North Michigan Ave., Chicago 11, Ill.

RESEARCH & DEVELOPMENT ENGINEERS

Wanted for advanced research and development. Should have extensive experience on analysis of electronic systems in the fields of microwaves, missiles, radar, servomechanisms, communications, navigational devices. Outstanding ability in E. E. or Physics required.

Please furnish complete resume, salary requirements and availability to: Personnel Manager,

W. L. MAXSON CORPORATION
460 WEST 34TH STREET
NEW YORK, NEW YORK

ELECTRICAL ENGINEER

Good opening for electrical engineer with suitable training and three to five years of experience in industrial electronics or allied work, including design and development of relay and tube circuits. Project method used in development work on timers, sensitive photo-electric relays, amplifiers, counters, measuring and recording devices.

Employment of long-range, permanent nature for properly qualified individual. Superior industrial relations and employee benefit programs. Replies will be treated in confidence and should give full details concerning personal qualifications, education, and experience.

P-6794, Electronics
330 West 42nd Street, New York 18, N. Y.



ENGINEERS

Attractive positions immediately available for:

PROJECT ENGINEERS

Experienced in design of automobile radio receivers.

SENIOR DRAFTSMEN

Experienced in the handling of mechanical layout work and design of automobile radio receivers.

RADIO ENGINEERS

To handle liaison work with radio and television production department.

In reply give only brief outline of work experience. Standard application blanks will be forwarded if detailed information or personal interview is desired.

Personnel Manager,
BENDIX RADIO DIVISION
Towson 4, Maryland

ENGINEERS

PROGRESSIVE ELECTRONIC RESEARCH AND DEVELOPMENT COMPANY

has several openings for Senior Electronic Engineers of superior ability, with experience in design and development. Excellent opportunities for top flight men. Send complete resumes and salary requirements to:

Personnel Department

MELPAR, INC.

452 SWANN AVENUE, ALEXANDRIA, VIRGINIA

WESTINGHOUSE RESEARCH

Openings in Pittsburgh

ENGINEER having three or more years experience in radar or television for work on television systems and television receiver research.

ENGINEER or **PHYSICIST** with experience in underwater acoustics.

PH.D. PHYSICIST with background for working on solid state problems.

ENGINEER or **PHYSICIST** for work on magnetic circuits and materials.

ELECTRONIC ENGINEER to work on advanced circuit design problems.

ENGINEER OR PHYSICIST with three centimeter wave guide experience.

For application address
Manager, Technical Employment
WESTINGHOUSE ELECTRIC CORP.
306-4th Ave., Pittsburgh, Pennsylvania

ELECTRONIC ENGINEERS

PHYSICISTS

SERVO & COMPUTER ENGINEERS

PROJECT ENGINEERS SENIOR ELECTRONIC ENGINEERS

This is your opportunity to go places
in Electronic Research and Development

MEN ARE ESPECIALLY NEEDED TO DO ORIGINAL WORK IN THE FOLLOWING FIELDS:

1. Pulse circuits including ranging, scope, video, trigger and square wave generator circuits.
2. Radar type transmitters, including high voltage power supplies, receivers and modulators.
3. Micro-wave antennae, radomes, wave guides and other radio frequency components of radar systems.
4. Servo-mechanism and controls.
5. Electronic Instrumentation.

For Personal Interview in Chicago on November 4, 5 and 6,
Contact The Glenn L. Martin representative attending
the National Electronics Conference

or send resume to

PERSONNEL DEPARTMENT
THE GLENN L. MARTIN COMPANY

Baltimore 3, Maryland

NO HOUSING PROBLEM IN BALTIMORE, MARYLAND

ELECTRONIC ENGINEERS WANTED

● TELEVISION

experienced in circuit designs, either video amplifier design or scanning circuit design.

● TRANSMITTER

SENIORS . . .

Technical graduates with a minimum of 6 years engineering and supervisory experience, capable of assuming responsibilities for directing engineers and designers on specific projects connected with pulse type transmitters and timer equipment.

INTERMEDIATE ENGINEERS . . .

Technical graduates or equivalent with at least a minimum 4 years practical experience in design of transmitter and associated equipment.

JUNIOR ENGINEERS . . .

Technical degree, minimum 1 year experience in development for production of electronic equipment.

RESEARCH CHEMIST . . .

Technical degree and experience for development work on selenium rectifier.

ENGINEERS . . .

Also needed having experience with telephone systems in general, particularly in voice frequency equipment engineering, toll transmission systems and carrier telephone equipment.

**SALARY COMMENSURATE WITH ABILITY
APPLY IN PERSON OR WRITE PERSONNEL MANAGER
FEDERAL TELEPHONE & RADIO CORP.
100 Kingsland Road, Clifton, N. J.**

PROJECT ENGINEERS

Real opportunities exist for Graduate Engineers with design and development experience in any of the following: Airplane Stability and control, Servomechanisms, radar, microwave techniques, microwave antenna design, communications equipment, electron optics, pulse transformers, fractional h.p. motors.

Send complete resume to employment office.

**SPERRY
GYROSCOPE CO.**
Division of the Sperry Corp.
GREAT NECK, LONG ISLAND

ELECTRONIC ENGINEERS PHYSICISTS

"A leading Electronics Company in Los Angeles, California offers permanent employment to persons experienced in advanced research and development. State qualifications fully."

P 6606 Electronics
68 Post St., San Francisco 4, Calif.

**Bachelors, Masters, PhD's in PHYSICS or E.E.;
Experienced Electronic Engineers;
Recent Graduates; and Technicians:**

OPPORTUNITY ON LONG ISLAND

offers attractive working conditions, salary commensurate with ability, access to graduate schools, first-rate research and plant facilities, other advantages.

Projects underway in fields of microwave receivers, transmitters, antennas; radar, air traffic control; servos, motor-control systems; general electronics.

In reply, write Personnel Manager

Airborne Instruments Laboratory
INCORPORATED

160 OLD COUNTRY ROAD · MINEOLA, N.Y.

CHIEF ELECTRICAL ENGR PROJECT ENGRS SENIOR ENGRS

Must have extensive experience in home radio receivers and/or television, design & development.

Address Replies To

Vice President in Charge Engineering

AIR KING PRODUCTS CO., INC.
170-53rd St. Brooklyn, N. Y.

X-RAY TUBE ENGINEER

EXPERIENCED MAN familiar with X-ray production and design methods. Excellent opportunity. Salary is open. Call or write. **Amperex Electronic Corporation, 25 Washington St., Brooklyn 1, N. Y.**

RADIO CABINETS

and wood cabinets of all types built to your specifications.

"Engineered Wood Production"

THOMAS MANUFACTURING CO.
NEENAH, WISCONSIN

● EXPERT DIAGNOSIS and TREATMENT ●

for Ailing Communication and Television Receivers and Transmitters
by TRAINED SKILLED TECHNICIANS

When trouble comes and your receiver acts up, don't blame sun spots . . . let factory trained experts check your set's health.

**HALLICRAFTERS HAMMARLUND COLLINS
NATIONAL PIERSON RME**

Complete realignment—Bandspread Calibration—Sensitivity Measurements—Image Rejection Ratios—S Meter Calibration. Rebuilding to rigid factory standards.

*Authorized Collins, Hallicrafter, National and RME
Service Center*

WINTERS RADIO LABORATORY

11 WARREN STREET Cortland 7-1361 New York 7, N. Y.

SAVE RESEARCH TIME BY CONSULTING The Indispensable Bibliographical Reference ELECTRONIC ENGINEERING MASTER INDEX

Descriptive Literature on Request
ELECTRONICS RESEARCH PUBL. CO.
2 W. 46th St., N. Y. 19



SURPLUS NEW EQUIPMENT



PORTABLE (CHRONOMETRIC) TACHOMETER

Jaeger Watch Co. Model #43A-6

- Can be used for speeds up to 20,000 R.P.M.
- Can be used for lineal speed measurements to 10,000 F.P.M.
- Ideally suited for testing the speeds of motors, particularly of fractional horse power, generators, turbines, centrifugals, fans, etc.
- Very small Torque—requires practically no power to drive.
- Unequaled Readability 2" Open face dial—each division on large dial equals 10 R.P.M.; each division on small dial equals 1,000 R.P.M.
- Greatest Accuracy—meets Navy specifications—guaranteed to be within 1/2 of 1%.
- Results of test reading remain on dial until next test taken.
- Push button for automatic resetting.
- Complete with the following accessories:
 - Large pointed rubber tip
 - Large hollow rubber tip
 - 6" circumference Wheel tip
 - Operating Instructions
 - Temperature Correction chart

The combination of the above features will give accurately, within a few seconds, by direct reading, the R.P.M. of shafts or the lineal speeds of surfaces without any accessories or timing of any kind. Each unit comes complete in a red velvet lined carrying case 5"x3 1/2"x1 1/2". Net List Price \$70.00—Surplus—New—Guaranteed. Your Cost \$24.50 F.O.B. N.Y.

A.C. VOLTMETERS

- 0-15, WH NA-35, 3 1/2" rd fl bake case, (100 MA) \$3.95
- 0-75, Weston 517, 2" rd fl metal case, ring mt'd. \$2.95
- 0-150, GE AO-22, 3 1/2" rd fl bake case \$5.50
- 0-150, Triplett 331-JP, 3 1/2" rd fl bake case \$4.50
- 0-150, W Resist, to increase range to 300 V, Triplett 331-JP, 3 1/2" rd fl bake case \$5.50
- 0-300, Burlington 32A, 3 1/2" rd fl bake case \$8.00
- 0-500, GE AO-22, 3 1/2" rd fl bake case \$12.00

A. C. AMMETERS

- 0-30, Triplett 331-JP, 3 1/2" rd fl bake case \$4.00
- 0-50, GE AO-22, 3 1/2" rd fl bake case \$4.50
- 0-60 & 0-120, Burlington 32XC, with current transformer \$7.50
- 0-75, Triplett 331-JP-C, 3 1/2" rd fl bake case \$3.50

R. F. AMMETERS

- 0-250 MA, WH NT-33, 2 1/2" rd fl bake case, black se cal 0-5 \$3.50
- 0-1, GE DW-44, 2 1/2" rd fl bake case, black scale \$2.95
- 0-1.5 Weston 507, 2 1/2" rd fl metal case, black scale \$2.50
- 0-2, Simpson 135, 2 1/2" rd fl base case \$3.50
- 0-2.5, Simpson 35, 3 1/2" rd fl bake case \$4.95
- 0-3, Simpson 135, 2 1/2" rd fl bake case \$3.50
- 0-4, GE DW-44, 2 1/2" rd fl bake case, black scale \$2.95
- 0-5, GE DW-44, 2 1/2" rd fl bake case, black scale \$2.50
- 0-20, Weston 507, 2 1/2" rd fl bake case \$3.50
- 0-30, Triplett, 0347-A, 3" sq fl bake case, W, ext. leads & couple \$8.00

D. C. MICROAMMETERS

- 0-200 microampere mt., GE DO-41, 3 1/2" rd fl bake case, Knife edge pointer, se mid "Set Carrier" supp with paper V.O.M.A. se \$6.00
- 0-200, Superior, 4 1/2" x 1 1/2" flush case, Knife edge pointer se cal 0-200 Meg & 20,000 ohms insulation Tester, 500 ohms resistance \$7.50
- 0-400, Triumph, 4" Rect fl bake case, 500 ohms resist, se cal 3/15/60 V MA \$5.50
- 0-500, Grein 221-T, 2 1/2" rd fl bake case \$3.95
- 0-500, GE DO-41, 3 1/2" rd fl bake case, se cal 0-20 KV, supp with paper V.O.M.A. se \$4.95

D. C. MILLIAMMETERS

- 0-1, Sun 3A1259, 3 1/2" rd fl bake case \$3.00
- 1-0-1, GE DO-53, 3" sq fl bake case \$4.50
- 0-15, Simpson 26, 3 1/2" rd fl bake case \$4.50
- 0-20, GE DO-53, 3" sq fl bake case \$3.25
- 0-25, Weston 301, 3 1/2" rd fl bake case \$4.95
- 0-80, GE DO-41, 3 1/2" rd fl bake case \$3.25
- 0-100, Weston 506, 2 1/2" rd fl bake case \$3.95
- 0-150, Gruen 508, 2 1/2" rd fl bake case \$3.00
- 0-200, Marion, 3 1/2" rd fl bake case \$4.00
- 0-500, WH NX-33, 2 1/2" rd fl bake case \$3.95

D. C. AMMETERS

- 0-5, Gruen, 2 1/2" rd fl bake case \$3.50
- 0-15, Triplett 0321-T, 3 1/2" rd fl bake case \$4.00
- 30-0-30, GE DW-51, 2 1/2" rd fl metal case \$3.50
- 0-200, GE DO-41, 3 1/2" rd fl bake case, with ext 50 MV (Aircraft style) stumt. \$9.50

D. C. VOLTMETERS

- 0-5, WH NX-33, 2 1/2" rd fl bake case, 200 r/v \$3.50
- 0-10, Sun 2AP458, 2 1/2" rd fl bake case, 100 r/v \$2.50
- 0-15, Gruen GW 505, 2 1/2" rd fl bake case \$3.50
- 0-30, GE DW-41, 2 1/2" rd fl bake case, approx 250 r/v \$2.95
- 0-50, WH NX-35, 3 1/2" rd fl bake case, 200 r/v \$3.95



PORTABLE TACHOMETER

Multiple Range Continuous Indicating
This unit is of the centrifugal mechanical type and is designed to show INSTANTANEOUSLY and CONTINUOUSLY the speed or change in speed of any revolving shaft or surface. No stop watch or other mechanism required.

- Three ranges in R.P.M. and three in F.P.M. Low Range 300-1,200 (Each division equals 10 R.P.M.) Medium Range 1,000-4,000 (Each division equals 10 R.P.M.) High Range 3,000-12,000 (Each division equals 100 R.P.M.)
- Large open dial 4" diameter.
- Ruggedly constructed for heavy duty service.
- Ball bearing and oilless bearings—require no lubrication whatsoever.
- Readily portable—Fits neatly into hand.
- Gear shift for selecting low, med., high ranges.

Made by Jones Motrola, Stamford, Connecticut. Comes complete in blue velvet lined carrying case: 7 1/2" L x 4" H x 5" W. List Price \$95.00—Surplus—New—Guaranteed. Your cost \$24.50 F.O.B. N.Y.

Gasoline Heater

Motorola

Model GN-3-24

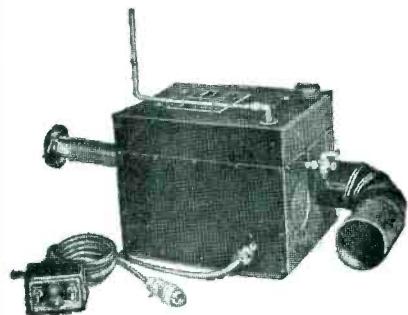

An internal combustion type heater which will give 15,000 B.T.U. of heat per hour. Ideally suited for use with equipment, farms, boats, bungalows, cabins, trailers, work sheds, darkrooms, mobile equipment, transmitter stations etc. and any place where a quick heat is required in volume. Very economical in operation—tank holds one gallon of gasoline which is sufficient for 6 hours operation. Uses any grade gasoline.

This unit is designed primarily for aircraft installation, 24-28 volts d.c., but it can be readily adapted for a 115 or 230 volt 60 cycle power supply by use of a transformer and rectifier. Simple circuit diagram for adaptation to 115 or 230 volt 60 cycle use supplied with each unit. Can be used on 32 volt farm or boat systems as is without the installation of additional transformers etc. Lower consumption approximately 75 to 100 watts.

Takes very little space—can be readily stored when not in use—measures approximately 12 long x 9 1/2" high x 9 1/2" wide—weighs only 30 lbs complete with all accessories.

These units are complete with exhaust pipe, 3" air duct elbow, control switch and cord, as illustrated, and are supplied with Technical Manual and Parts Catalog.

SIMPLE TO INSTALL—SAFE TO USE—NO ODORS
BRAND NEW—IN ORIGINAL CARTONS—READY TO USE

Made by Galvin (Motorola) Mfg. Company.

NET PRICE **\$22.50**

SPECIAL METERS

- FREQUENCY METER**—Range 350 to 450 cycles, 115 volt A.C. Iron core dynamometer type movement, 5 cycles per scale division. Black scale luminous markings, Weston Model 637, 3 1/2" Aircraft style \$4.95
- FREQUENCY METER**—J.B.T. 30-F dual range covers Frequency ranges from 48-52 cycles and 58-62 cycles. Dual element, Vibrating Reed type 115 volt, 3 1/2" rd flush metal case \$5.95
- DECIBEL METER**—Weston 506 minus 10 to plus 6, 6 MW in 600 ohms, 2 1/2" rd fl base case \$5.50
- HOUR METER**—Totals to 99,999.9 hours and repeats. WH NH-35, 3 1/2" rd fl bake case. Operates on 230 volt 60 cycle \$8.50
- D. C. MILLIAMMETER**—Weston 271 fan type, 1-0-1 MA (60-0-60 MV) movement Se cal 600-0-600 R.P.M. \$12.50

SWITCHBOARD METERS

- FREQUENCY METER**—53 to 62 cycles, Westinghouse 11Y 5 1/2" square proj. mt'd case; accuracy within 1%. Electric Dynamometer type movement; Comp. with ext. reactor \$39.50
- FREQUENCY METER**—50 to 70 cycles, Westinghouse 11Y 5 1/2" square proj. mt'd case; Accuracy within 1%. Electric Dynamometer type movement; Comp. with ext. reactor \$45.00

All items are Surplus—New—Guaranteed. C.O.D.'s not sent unless accompanied by 25% Deposit. Orders accepted from rated concerns, public institutions, etc., on open account. The above is only a partial listing of the many items we have in stock. Send for free circular. MANUFACTURERS, EXPORTERS, DEALERS—we invite your inquiries.

MARITIME SWITCHBOARD

336 Canal Street Worth 4-8217 New York 13, N. Y.

We carry a complete line of surplus new meters suitable for every requirement, such as portable, panel, switchboard, laboratory standards, etc.

OVER 50,000 METERS IN STOCK

We also have in stock various surplus components, tubes, code keying and recording units, coil training sets, tachometers, analyzers, tube testers, converters, precision resistors, current transformers, transmitters, receivers, condensers, and other electronic units, parts and accessories.

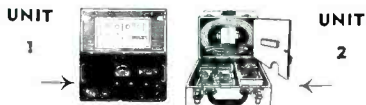

MICROWAVE TS-12AP TEST SETS — BRAND NEW!

US Navy 2-unit MICROWAVE Test Set UNIT 1—STANDING WAVE Indicator-Amplifier w/linear STANDING WAVE RATIO METER (15 microvolt full scale). Precision measurements of standing waves in plumbing or coax lines. TR & RT boxes, xtal mixers, antennae. Used & supplied w/UNIT 2—SLOTTED SECTION CG87/U (1/2 mm calib) & gear driven movable probe & Xtal assy MX158/U & BOLOMETER or Xtal det. 3 Waveguide Coax (UG79/U, 2—UG81/U) adaptors, 7-IN series-Xtals, 1—Choke & Flange coupled large-to-small wavegd adaptor UG80/U, 1 terminating sect CG88/U w/4" Res strip, RF (CG92/U) & Sync (CG89/U) Cabling, adaptors CG90 U, supports, UHF plugs, ALL accessories. Amplifier (Unit 1) linear 400-2500 cps, 3 hi-gain stages, 2 input channels w/sep gain cont, chan sel sw, master gain cont. Write for SPECS. Ea. unit sep cased. Units 1&2 COM- PLETE \$298.50

GIBSON Girl XMTR T74/CRT3 p/o SCR578 Like new S0S xmtr & Crank Dyn 28V&300V also tubes Parts & Xtal 8280KC. SPECIAL \$5.95
 G'GAL Sig Lamp & Ant. .89
 G'GAL Haversack Bag w/proof. .98
 G'GAL BOX KITE 17x17x36". 2.98
 GIBSON GAL PARACHUTE 12 foot. .298

HIPOWER VARIABLE ANTENNA MATCHING NETWORK 100A1 KW RF NEW 1.5 to 7 mc's convertible to Hi-freqs. PiNetwork adjustable IN & Output CASED 15 x 15 x 23" RACK MTG Ribboncoil & 250mmf/7000V V-condsr RFmtr, Instlrs Technmanual will match most ANTS. NEW requires recentering coil turn SPECIAL \$9.95



Same Unit NEW.\$12.95
 SAME UNIT, NEW, broken coil .85

RCA AUDIO AMPLIFIER Hvy duty CHASSIS Hi Porcelainized Gray rustproof 7/4 x12 1/4 x 4 1/4" 9 Amphenol sockets including 6 octal, 3 inputs, cutout for pwr transf & choke, Chassis marked for 2mic, Vol, tone, fuse, tubes 3—6V6GT, 5Y3GT, 6SN7GT, 6J5 & 6J7, Spkr. Complete with 3FP triple section Electrolytics (1—30mf/450VW&2X20mf/25WV 2—10mf/450VW&2X20mf/25WV) "TAB" SPECIAL 2.49 ea. 5 for \$10.98



CONSTANT V'REGULATOR NEW RAYTHEON in 95-130V/60 cy; Output 115V/60 cy Csd. \$10.95 RAYTHEON in 198 to 242 Vmpt/50-60 cys: Output 220V/500 Watts/0.5% Roltm Rack mtg \$36.00 SOLA CONSTANT V'REGLTR USN Cased in 95 to 190V/50-60 cys: Output 115 or 220V 2KW/17.4 Amps/Constant Duty 1% Regulation 1N*. \$130.00 Same Unit NEW, USN Cost \$369. Only \$162.00

BATTERIES STORAGE AND DRY TYPES

- (A) BR18/BB52/5oz/36V minSBaty ea. \$1.49 8 for 10.00
- (B) BURGESS 3V F2BP/dated 6/47 5 for \$1.00
- (C) GOULD 6V/15AH S'Baty USN NEW \$3.98
- (D) BB54/2V 27 amp WILLARD S'Baty \$1.98
- (E) WILLARD 4V/40AH/TBY S'Baty \$5.95
- (F) BB206U/2V 11AH WILLARD S'Baty \$1.89

Collins Art-13 Speech Amplifier
 Dynamic or Carbon Mike or Line inpt, Audio Driver to PPG & Monito tube. Less Tubes. \$4.50
 SAME & CLIPPER KIT & TUBES & Data. NEW. \$8.25
 Cased Filters 0.1 to 1000 mc's/USN .129
 TOBE 30amp 250 VACDC filters 0.15 to 1000mc's USNesd Cont duty \$4.50
 @ \$2 for 8.00
 GE 100 amp filters & 2x5 mf/50V oil filled Cndrs operates 110VACDC SPECIAL \$1.98



PRECISION RESISTORS "TAB" SPECIALISTS IN PRECISION RESISTORS
 Write Qty \$

"NO MFGS CHOICE. We ship types in stock"	
1116	170
42	182
425	199
607	200
209	216
216	219
220	220
220	220
225	225
230	230
235	235
240	240
245	245
250	250
260	260
271	271
275	275
280	280
286	286
289	289
299	299
300	300
310	310
311	311
320	320
325	325
340	340
350	350
350	350
366	366
370	370
375	375
380	380
390	390
400	400
410	410
414	414
418	418
425	425
425	425
440	440
440	440
450	450
452	452
452	452
475	475
478	478
480	480
487	487
500	500
520	520
525	525
540	540
550	550
575	575
580	580
600	600
607	607
612	612
625	625
633	633
640	640
641	641
649	649
650	650
657	657
665	665
669	669
670	670
675	675

ABOVE SIZES EACH 30¢ @ .10 TEN FOR \$2.50
 100000 155000 240000 353500
 110000 166750 245000 380000
 115000 169360 250000 400000
 120000 180800 265000 402000
 125000 185000 268000 422000
 130000 201000 275000 430000
 135000 220000 294000 478000
 140000 225000 307500 500000
 145000 229000 314000 520000
 147000 235500 330000 521000
 150000 238000 335500 570000
 ABOVE SIZES EACH 4¢ @ .10 TEN FOR \$3.50
 1 Meg 2 Meg 3.5 Meg 4.23 Meg 10 Meg
 1.2 2.855 3.673 4.5 11.5
 1.5 3 3.9 5 12.83
 1.8 3.673 4 9.05 20

Vacuum Precision Hivolt Resistors (C)
 .12, .25, .6, .75, .83, .99 megohms
 1, 1.5, 2, 3, 3.75 megohms 0.5% accuracy
 SPECIAL \$1.00 @ .10 TEN FOR \$7.50
 SEALED 10w/12Men/10KV/9W \$1.35 @ 10for \$10.00
 MVZ8/20Watt/30Megohms/25KV\$1.98 @ 6for \$10.00
 MFB105/1Meg/.5% acy/Jan, R-29
 198 @ 6for \$10.00
 Type 2/20megJANR29/20KV/0.5% gacy \$29.95
 200B/675Watt/0-135V GR. 10.95
 200C/860Watt/0-135V GR. 16.50
 100R/0-230or270/2KW/115or220Vin 39.95
 AN/AP4 RECEIVER & COILS Write for details
 OILS/MFD/600WV/220VAC&brckts 2 for .98
 ELECTROLYTIC SPECIAL
 FP Type 30mf/450V&2x20mf25V also One10mf/450V&2x20mf/25V Both for .59

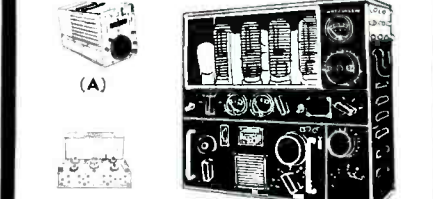

(A) BC457 XMTR 4-5.3Mc LIKE NEW & TUBES \$7.95
 (A) BC457 XMTR 4-5.3Mc Good used & tubes 5.95
 (A) BC458 XMTR 5.3-7Mc LIKE NEW & Tubes 7.95
 (A) BC458 XMTR 5.3-7Mc Good used & tubes 5.95
 (A) BC458 XMTR 5.3-7Mc As IS less tubes. 3.49
 (B) BC456 Modulator & Tubes & Dyn Good used. 4.98
 (B) BC456 Modulator less tubes & Dyn used. 1.69
 (V) BC375 XMTR Good used w/ tubes kone TU. 12.95
 (C) BC375 or BC191 as is, less tubes & TU. 14.44

PHOTOFLASH & 2 KRYPTON LAMPS NEW
 AIRCORPS 1503 SET CONTAINS PWR

SUPPLY LAMPS
 Reflectors, HV rectifier, Condensers 2x25 mfd, HV transformer Relay, light output 12,000,000 lumens. 15to30000flashes for Color&B/Wfilm KIT includes INSTRUCTIONS & PARTS to CONVERT 12 to 24VDC unit 115VAC OPERATION "TAB" SPECIAL \$59.95
 PHOTOFLASH 1503 & RECTIFIED POWER SUPPLY for 115VAC operation READY TO WORK. \$9.50
 PHOTOFLASH KRYPTON LAMPS&Reflector 2 for \$21
 PHOTOFLASH CONDENSERS
 8mf/60V/660VAC/3000VDCintermittent .4 for 11.95
 16mf/660VAC/3000VDCintermittent 7.95
 15mf/330VAC/2000VDCintermittent 4.50
 25mf/330VAC/2000VDCintermittent 7.95
 16mm/PAN/50Film GSAP Camera. .54 for 8.98
 16mm/PAN/Film Gun Camera GSAP. .10 for 1.98



METER GE/200MICROAMPdc/4"SQUARE/ 5 scales ACDCV&Ohms in Red & Black, K.E. Pointer NEW 6.95
 METER 50MICROAMP,dc/4"SQUARE/VOM 5 scales, 9 ranges ACDCV & DC ma & DB in Red & Black, K.E. pointer, used in GE Unimeter 9.49
 METER DB WESTON 506 minus 10 plus 6/ 6MW 600 Ohm Bakelite Cased JAN MR25W-123 spec 5.49
 METER TUNING 5ma WESTON 2 1/2"B'CSd. 1.49
 METER One Ma DeJUR 2 1/2"B'CSd. 3.95
 METER Two Hidamping 4"/10x40 Ma/.5% WESTON 12.95
 METER GALVOMA GE 2.5&25 Ma 0 Center. 3.95
 METER TWIN MVT 0-200&100-0-100 Microamp aircraft 2.95
 METER RF One Amp 2 1/2"B'CSd GE 3.95
 METER RF 5or9am2 1/2"B'CSd GE&WSTG ea 3.49
 METER RF 750ma & ext couple WESTON 2 1/2" CSD 3.49
 METER AmpDC 15 amperes 2 1/2" Csd Hoyt. 2.95
 METER AmpDC 240amps/50Mvmvt 2 1/2"B'CSd 2.49
 METER VoltsDC 30 Volts AN 2 1/2"B'CSd WSTGHSE 2.49
 METER VDC/200Vor500V/Mohmsp/v3 1/2" B'C/W.E. 4.95
 METER VDC 2000V/Mohms p/v/2 1/2" B'CSd GE 5.95
 METER VDC 10000V/Mohms p/v/3 1/2" B'CSd. 12.95
 METER AC 150V/25to125/cy/2 1/2" WSTGHSE & GE 3.95
 METER AC 7.5V/3 1/2" B'SQ/RA35 WSTGHSE 4.49
 METER AC 15V/3 1/2" B'SQ/476 WESTON 4.95
 METER 182 360c AUTOSYN BENDIX 4.95
 TEST LEADS 8"&CLIPS Instltd/30amp49c @ 2 for 1.20
 TEST PRODS 4" instld plugs&tips Red&Blk49c @ 2 for 1.20
 POWERSTAT in115V/out 0-135V/2KW. 29.95

Blowers—Cool That Tube!
 40 CFM/28VACDC 2.98
 100 CFM/12VACDC 5.95
 100 CFM/28VACDC 4.95
 XFORMER 12 or 28V to 115VAC for above. 1.69
 250 CFM/28VACDC 8.95
 250 CFM above plus 28/115VAC XFORMER. 10.95

"TAB" MONEY BACK GUARANTEE
 \$3 MIN. ORDER F.O.B. N.Y.C.
 ADD SHIPPING CHARGES AND
 25% DEPOSIT. PHONE WO.2-7230

THAT'S A BUY

"TAB" MONEY BACK GUARANTEE
 \$3 MIN. ORDER F.O.B. N.Y.C.
 ADD SHIPPING CHARGES AND
 25% DEPOSIT. PHONE WO.2-7230

DEPT. 11E SIX CHURCH ST. NEW YORK 6, N.Y., U.S.A. CORNER CHURCH & LIBERTY STS. N.Y.C. 288-2883



KIT 866A's & XFORMER, input 115 VAC, 50-60 cys, output 2.5 VCT/10 Amps 10 KVinsulation and JOHNSON sockets & TUBES, SPECIAL... 5.95
KIT GE872A's & XFRMR, 12.5KV, insita & sockets SPECIAL... 12.95

COMPLETE TELEVISION POWER SUPPLY Kit Hi Voltage 5000VDC/5ma LO Voltage 300VDC/175ma output, fil 6.4V/10.3A, fil 5.4V 8A, 5.1V/3A&5V/3.5A inpt 105, 115, 125V/50 to 425cys & sockets & Rect tube 5U4G&5B24 & filter condensers & choke & diagram oil filled USN Transf W.E.D303184 "TAB" SPECIAL \$27.95 TRANSFORMER only, \$22.95

SAME TELEVISION POWER SUPPLY KIT & added parts for providing Hi VOLTAGE DOUBLER circuit—with 10000 Volts dc output "TAB" SPECIAL \$34.95

TRANSFORMERS 115 V/60 Cy. Input
7500V or 15000V DOUBLER/35ma... \$15.95
10800VCT or 21000V DOUBLER/95ma... 19.95
500VCT/60ma, 6.3V/4A Hmtclly Cascd... 1.29
1100VCT/212ma \$5.95; 10V/8A/12KV... 6.95
5V/115Amp \$10.95; 2.5V/10A/10KV... 3.95
220 to 440V-or-110 to 220V 250Watt... 4.95
880VCT/125ma, 6.3V/2A, 6.3V 3A&5V/3A delivers 250ma on hiv... 4.45
5V/60Amp KENYON HV insitd... 6.95
840VCT/110ma, 540VCT/21ma, 5V/3A, 5V/3A&6.3V/1A, 6.3V/6A USN Csd 2X safety factor... 4.95
2.5V 40Amp GE insitn 25KV... 7.95
6800V or VCT/1A/17KVinsitn, 208 to 251V 81.00
3400V or VCT/1A17KVinsitn, 107 to 126V 81.00
115 or 230V/10Amp/2KW TRANSFORMER... 19.95
115 or 230V 8Amp/1.8KV AUTOTRANSF... 16.95
5V/6.5Amp/36KV insitn & socket UX... 6.95
7.5VCT 6.5A, 6.3VCT/3A... 3.75
700VCT/150ma, 10V/3.25A, 2.5V/10A & 3VCT/2A, 5V/3A, H V insitd. Cascd... 5.95
1100VCT/150ma, 6.3V/3A, 5V/3A HV ins... 4.50
10V 8A/12KV or 2x5V/8A/12KV ins... 6.95
1000VCT/150ma, 300Vbuss, 6.3V/5A, 5V/3A & 2x6.3V/6.5A, 6.3V/1.25A CSD50-800cys & pri taps 0-80 115VAC Hmt sealed... 4.50
7.5V/12A/HV \$4.95; 4x6.3V 4A&3x5V 4A... 4.50
10VCT/10A/220Vin or 5VCT/10A/110Vin... 4.95
5VCT/20A/220Vin or 2.5VCT/20A/110Vin... 5.95
10VCT/10A, 12VCT/7A, 3x6V/1A, 2x6V/2A 3x5V/3A, 2.5V 1.75A, 6.4V/12A, 6.4V/10A 1200VCT/500ma \$4.50 @ ... Two for... 9.98
3200VCT/200ma & 780VCT 12VCT/5A... 12.95
60VCT/120ma, 115V/100ma, 6.3V/2A & 6.3V 2A, 5V/2A CASED HVinsitd... 3.25
Universal Vibrator Transf 6.12, 24, 115DC & 115&230VAC50-60cy, 420VCT/85ma, 6.3V/3A 500V/3A\$10; 2/319; 75V/24A/220Vin... 3.95
2240VCT/500ma, Pri105to250V/50-60cy2.5 V/10A, 12V/4.5A, 19V2.5A\$24.95 2... 47.00
250VCT/60ma, 6.3V1.5A Small... 1.49

CHOKES

13.5Hy/1Amp/42ohm/17KVinsl... \$54.00
15-29Hy/150ma Swinging Cascd... 2.95
12Hy/300ma \$3.95; 3Hy/40ma... 3 for 1.00
15Hy 400ma or 20Hy/300ma/12KV ins... 7.95
8Hy/150manewUTCrckd&BlkltE Bd2/2.25 50Hy/125ma Csd... 1.95
8Hy/100ma/\$1.10; 12Hy 275ma... 3.29

CERAMICS, HIQ, CAPACITORS NEW!



(A) ERIE DUAL TD2A/4-30mmf #45 @ 10/2.49
(B) ERIE TS2A/4.5-5-25mmf #27 @ 10/2.49
(C) ERIE TS2A/4-30mmf #27 @ TEN for 2.49
(D) ERIE TS5D/5-30mmf #54 @ TEN for 4.98
(E) ERIE TS5D/10-110mmf #54 @ TEN for 4.98
(F) MEISSNER 1to12mmfHFadder #12; 10/\$1
(G) TRIMMER 2to30mmf #9 @ 12 for .98
F H J 2,3,4,7, 5, 7, 5, 10, 11, 22, 25, 33, 43, 47, 50, 60, 75, 100, 120, 200 1000, 6200mmf, "TAB" SPECIAL #9; 10/75e; 100/6.95
(G) ERIE K/CC21 5. 39mmf #20 @ 6 for... 1.00
(G) ERIE L/CC26/27, 30mmf #20 @ 6 for... 1.00
(G) ERIE M/CC36 33mmf #25 @ 5 for... 1.00
(G) ERIE N/40, 45, 50, 100, 1000mmf #09 @ 12for 1.00
(G) ERIE Feedthru 50 or 100 mmf #18 @ 7 for... 1.00
ERIE 370 EF Button 400mmf #18 @ 7 for... 1.00
ERIE 741A/N750/50mmf; Hikap 10KV Peak
ERIE 741A luc type 185, 200, 280, 400mmf... 1.25

VARIABLE CONDENSERS



(A) Cardwell/Millen 150mm/3000V gap HF... 1.00
(B) DUAL 15 mmf per Sect/3000V gap... 7.99
(C) BUD DUAL 75mmf/sec/1000V gap/HF... 1.49
(C) JOHNSON 70H30/74mmf/3000V gap... 1.29
(D) CARDWELL NEUT ZT/12mmf/5000 Vgap/locknut... .98
PHASING CONDNR W.E. 90° Quadrants/4 taps, 360° SINEWAVE GENERATOR Variable 2.39

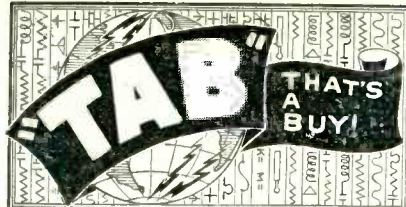

GE GL434A similar to 7C29 TRIODE useable maxinpt 110mc's Uptto1200 Watts input, UP to 600W output, 3 Terminal Grid & C. T. filament, forced air Cooling 75-200CFM, Ef 10-11V Dsgn for RADAR/BC-677 operated 215mc's/12KV/310ma inpt "TAB" SPECIAL \$7.95
REL36ACORN similar 6J4... 1.93
9LP7 Magnetic DEF/FCOCUS Suitable for TELEVISION... 3.98

TUBES

OA4G...	\$1.04	6N7...	.85	872A...	2.45
OZ4...	.85	6S7...	.87	884...	.89
1B3GT...	2.00	6SA7GT...	.54	918/CE1C...	1.49
1B21/471...	2.95	6SG7...	.71	922...	1.49
1B24...	2.95	6SF5...	.60	923...	.75
1B27...	3.95	6SG7...	.71	931A...	3.95
1D5GP...	1.25	6SH7...	.63	954...	.45
1G6GT...	.85	6SJ7...	.72	955...	.63
1L4...	.70	6SJ7GT...	.58	956...	.63
1LC6...	1.05	6SK7...	.58	957...	.45
1LH4...	1.05	6SL7...	.85	958A...	.63
1LN5...	.81	6SN7GT...	.69	991...	.25
1P5GT...	.63	6S07...	.54	1613/6F6X...	1.50
1P24...	2.95	6SS7...	.71	1614/6L6X...	1.50
1R4/1294...	1.00	6V6GT...	.69	1616...	1.39
2A1A...	2.85	6U7G...	.58	1619...	.39
2A3...	1.04	6X4...	.53	1622...	1.69
2C21/1642...	.81	6X5...	.81	1624...	.98
2C26...	.55	6Y6G...	.85	1625...	.45
2C34/RK34...	5.65	6Z4/84...	.69	1626...	.45
2C40/446A...	.81	6Z7GT...	1.23	1629...	.58
2C43...	2.98	7B7P-1813...	3.95	1635...	1.90
2D21...	1.49	7C29/434...	7.95	1641...	.75
2E22...	1.45	7C4/1203...	.98	2050...	.88
2E25/HY65...	1.95	9J1...	3.95	2051...	.88
2J19/725...	12.95	9J12...	9.00	713...	3.38
2J26...	12.95	9L9P7...	4.35	8005...	4.70
2J30...	18.50	10Y...	.60	8012...	4.70
2J31...	16.95	12A6...	.49	8013A...	3.95
2J32...	16.95	12AH7GT...	.87	8020...	3.49
2J33...	14.50	12AR7...	.95	9001...	.49
2J34...	18.95	12DF7...	14.75	9002...	1.83
2J42/700...	29.95	12GP7...	14.75	9003...	4.49
2J49...	29.95	12SA7GT...	.58	9004...	.49
2J55...	35.00	12SG7...	.65	9006...	.49
2J61A...	39.95	12SH7...	.71	CEJ...	4.95
2K25...	9.95	12SK7...	.58	CE206...	3.95
2K28...	7.00	12SQ7...	.58	CE215...	5.95
2K29...	6.95	13C3...	.95	CE205...	.35
2V3G...	1.05	15E...	1.39	FI17A...	18.00
2X2...	.54	24C/3C24...	.68	FG104...	14.95
3A4...	.0	25L6GT...	.68	FG105...	11.95
3B7/1291...	.95	25Z5...	.53	FG166...	49.00
3B24...	1.27	35L6GT...	.58	HY65/2E25...	2.95
3BP1...	1.39	35Z5GT...	.42	REL36/6J4...	1.98
3BP1A...	2.95	37...	.78	RK215...	7.95
3C23...	4.95	41...	.58	T200...	12.00
3D6/1299...	.85	50L6GT...	.58	VR90/0B3...	.74
3E29/829B...	3.85	80...	.52	VR92...	.39
3FP7...	3.98	83V...	1.05	VR105...	.70
3JF12...	2.95	11Z6...	1.10	VR150...	.94
3S4...	.69	20B1/VT2...	1.25	WE215A...	1.83
4J47...	39.95	211...	.89	WL468...	0.95
5A1P...	2.75	250TH...	19.49	WI530...	49.50
5BP1/5GP1...	1.95	250TH...	19.49	WL531...	9.95
5BP4...	3.95	304TH...	5.95	WL619...	20.00
5CP2...	3.85	304TH...	1.98	WL632A...	12.95
5D21...	19.00	307A/RX95...	4.25	WT6653...	2.95
5FNP7...	2.95	388...	1.59	TUNGAR*	
5HP1...	4.95	393...	5.95	20X672*	2.95
5R4G...	1.25	450TH/...	29.90	199698*	2.95
5T4...	1.25	6C21...	24.90	289881*	2.50
5U4G...	5.13	150TL...	29.90	MAZDA PL...	.60
5V4...	5.07	1000S...	11.95	85*Box 10...	.07
5W4...	.87	631P1/SN4...	3.95	64**...	.14
5Y3...	.38	63A...	8.95	56*/T4**...	.25
5Z3...	.89	701A...	3.95	100W/20V**...	.10
5Z4...	.88	702A...	3.49	313/28V**...	.10
6AB7...	.98	703A...	4.90	323/3V**...	.10
6AC7...	.81	705A...	1.59	Aviation Lts...	
6AG5...	.93	705A...	2.25	G1249/12V...	
6AG7...	1.05	707B/2K28...	6.95	GR-25 for 1.00	
6AJ5...	.98	710A/8011...	2.75	Sealed Beam...	
6AK5...	.90	717A...	1.49	4522/250W...	1.49
6AL5...	1.11	722/287A...	9.95	4560/600W 3.50	
6B4C...	1.28	723AB...	5.50	NEON BULBS...	
6B8G...	1.05	726A...	6.95	NE2-100...	4.50
6C4...	.27	802...	2.95	Oxy...	.25
6C5...	.54	803...	7.95	NE16/991...	.25
6C6...	.71	804...	9.75	NE51/NE20...	.08
6C8G...	1.85	805...	4.50	Orv100...	
6D4...	1.05	807...	1.24	NE20...	6.00
6D6...	.59	808...	2.25	SOCKETS for...	
6E5...	.71	810...	6.95	2Y2HV...	.30
6F6/1613...	.69	811...	2.20	705/715...	.69
6F8...	1.04	813...	6.95	803/304T...	.90
6G5/GU5...	.85	814...	2.98	807...	.27
6G6...	.86	815...	2.45	813...	.69
6H6GT...	.54	816...	1.15	827/832...	.25
6H6...	.54	826...	1.72	866...	.24
6J4...	5.95	828...	10.00	872/211...	.49
6J5...	.53	829B/3E29...	3.95	ACORN...	1.00
6J6...	.90	832...	3.75	5 for...	
6J7...	.79	836...	1.12	Dihental...	.59
6K5GT...	.86	837...	2.25	Miniral...	
6K6GT...	.54	845...	4.75	Loktal...	
6K7...	.70	860...	2.49	49SSL...	.24
6K8...	.86	864...	.67	Octal 788S...	.06
6L6...	1.27	865...	1.00	Octal 49SS8...	.15
6L6G...	1.04	866A...	1.00	Mfn 59500...	.12
6L7...	.85	868...	1.83	Mfn & SH...	.25

PRICES SUBJECT TO CHANGE

SWITCHES, MICRO, TOGGLE, ETC.

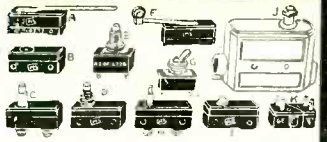

- A) MU/Leaf Sw 3/2" DPNO&NC/15A 1/2" @ .98
- B) MICROSWITCH Pin Plunger SPDT 10A @ .54
- C) MICROSWITCH Plunger SPDT/10A @ .59
- D) MICROSWITCH Plunger SPNO/10A @ .69
- E) ARROW H & H PLUNGER SPNO/6A @ .39
- F) MICROSWITCH ROLLER SPNC 10A @ .39
- G) AH & H Toggle 6A/DPDT 30e @ 4 for... 1.00
- H) MICROSWITCH PLUNGER SPNO*NC @ .59
- I) MICROSWITCH SPDT w/reset... .65
- J) MICROSWITCH PLUNGER Button SPDT @ .69
- K) SWITCHETTE DPNO&NC 30e; SPNO @ .25

IN	OUT	AMPS	PRICE	IN	OUT	AMPS	PRICE
18	14	1.35	2.49	36	28	1.5	3.95
18	14	3.5	3.49	36	28	3.5	6.75
18	14	5.	4.85	36	28	5.	7.50
36	28	.320	1.49	90	75	0.15	1.49
210	190	.04	.79				

Write for LIST



HEINEMAN MAGNETIC BKRS 10 ma. 220 ma 3, 5, 10, 15, 20, 30, 40, 80, & 180 amps NEW, each 1.95; Asstd... 10 for \$18.00
SQ'D, KLIXON & CH 5, 10, 20, 25, 33, 35 & 60 70 Amps, 98e each... 10 for 8.00
THERMOSTAT 85°F/20A adjustable... .49e
FUSE HLDR 1075 Littlefuse 20e @... 10 for 1.75
FUSE HLDR 4AG/HCM-BUSS 30e @... 10 for 2.50
FUSES 250ma/3AG Littlefuse 10e @... 10 for .79
FUSES 200ma/8AG Littlefuse 10e @... 10 for .79
FUSES 4Amp/3AG 25 for 50e... 60 for 1.00
FUSES Grasshopper Phone 3 for 25e, 15/ 1.00
AUTOSYN AY185/24Vin/60-400cy... 3.95
AUTOSYN type 5/115V/60cy LN*... Pair 8.98
AUTOSYN type 5/50V/60cy 2 for 115V op... 4.98
AUTOSYN type 5/50V-nair&Differential (1) 6.98
AUTOSYN type 5 Sync Differential 115V/60cy 4.98
GE SELSYN 2J55V1/110V/60cy @... 8.98
GE SELSYN 24V/TypeT&FL0AT can be used as liquid indicator or control system when float is removed... PAIR 1.98

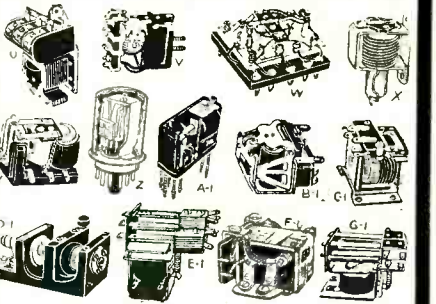

RELAYS

- G'DIAN 500AC/op18-24VAC/4PSTNO/8A... \$1.25
- S'DUNN 32AXX10Reset&O'land 10ma&115VAC 4.95
- GE Sealed pin 200ohm/SPDT/5A cts... 1.98
- ALLIED STK/6to12VDC DPDT&SPNO&NC... .98
- ALLIED CONTROL STK/7.5to24VDC/SPDT... .75
- GE CR2791B100J3 3PDT/24V/5A contacts... 1.39
- S'DUNN 17AXX109/115VAC/SPNO/6 cts... 1.98
- KURMAN 4maSens 650ohm/DPDNO&LNC/5amp.2.25
- GE CR2791-B100F3/24V DPDT/5Amp Cts... .98
- G'DIAN 1250V/4to 12VDC/SPDT/8A Cts... .98
- G'DIAN 4500 ohmCoil/SPST/5A Cts... .98
- LEACH 115VAC/DPDT/10Amp Contacts... 1.98
- R22 12V/DPT/SPSTNO/15Amp Contacts... 1.69
- U) Abardley 702/110VAC/3PSTD break 25A 4.49
- V) ALLIED BJ 6V/DPDT/5Amp Contacts... 1.89
- V) ALLIED BJ 7.5VAC/DPDT 5Amp Contacts 1.98
- V) ALLIED AS 24V/5A/SPDT/5A Cts... .98
- W) ADVANCE 4001B Ant DPDT&SPNO 15A CeramicHFin5to110V\$2.75 @ & Rec115VAC 3.25
- X

SEARCHLIGHT SECTION

AN/CPN-6, 3 CM RADAR BEACON INSTALLATIONS

*WIRE WOUND RESISTORS

Stock No.	Ferrule Resistor Description	RW 14F
46-189-2	9000 ohms @ 40 watts	
46-189-12	400 ohms @ 50 watts	RW 13F
46-189-7	16,000 ohms @ 40 watts	RW 14F
46-189-22	70 ohms @ 90 watts	RW 12D
46-189-17	20 ohms @ 90 watts	RW 12D
46-189-18	30 ohms @ 90 watts	RW 12D
46-189-4	10,000 ohms @ 40 watts	RW 14F
46-189-20	40 ohms @ 90 watts	RW 12D
46-1985T-1	5000 ohms 10 watts 5%	
46-2065	7500 ohms 10 watts 10%	
46-128-7	7500 ohms 10 watts 10%	
46-58T-8	7500 ohms 50 watts	
1W-996-2	8300 ohms @ 20 watts, 70F	
1W-996-3	1750 ohms @ 10 watts, 10F	
1W-996-4	200 ohms 5% @ 10 watts, 10F	
1W-996-5	20 ohms 5% @ 15 watts, 15F	
1W-996-6	800 ohms 5% @ 20 watts, 20F	
1W46-1766-1	5000 ohms 5% @ 20 watts	
	2 1000 ohms 5% @ 20 watts	
	-3 2000 ohms 5% @ 20 watts	
3W-46-1076-1	0.33 ohms @ 10% @ 5 watts	
3W-46-188-6	160 ohms @ 25 watts 10%	
	-11 250 ohms @ 90 watts	
	-12 2500 ohms @ 50 watts	
	-29 1.0 ohms @ 90 watts	
3W-46-950-4	2500 ohms @ 120 watts	
	-5 50 ohms @ 120 watts	
	-9 1250 ohms @ 120 watts	

46-189-23	75 ohms @ 90 watts	RW 12D
46-189-27	775 ohms @ 50 watts	RW 12D
46-189-28	800 ohms @ 50 watts	RW 13D
46-189-29	4000 ohms @ 50 watts	RW 13D
13786-T-2	1250 ohms	CSF6383F
13786-T-3	16,000 ohms	CSF63157F
13786-T-12	25,000 ohms	CSF63267F
46-1022T-1	14,000 @ 6 watts	
6-1023T-4	100	CSF 1
46-597-T-15	30 ohms, 100 W, Ferrule, #CAO 63179	
46-597-T-19	70 ohms, 120 W, Ferrule #CAO 63366	
46-597-T-33	450 ohms, 120 W, Ferrule #CAO 63196	
46-597-T-35	500 ohms, 120 W, 9 taps, Ferrule #CAO 63231	
46-597-T-28	198 ohms, 120 W, 10 taps, Ferrule #CAO 631134D	
46-597-T-25	225 ohms, 120 W, Ferrule #CAO 63191	
46-3818-T-13	4500 ohms, CSF 63211	
46-3818-T-12	3,000 ohms, 120 W, 9 taps, Ferrule #CIR 63236-D	
46-3818-T-11	630 ohms, 120 W, Ferrule, 10 taps, #CHD 631135D	
46-3818-T-1	Meg-o-max, 8000 ohms #CSF 63152-F	
46-3818-T-4	Meg-o-max, 12,500 ohms, #CSF 63831-F	
46-597-T-21	Meg-o-max, 100 ohms, #RW11F101	
46-597-T-22	125 ohms (100 W) Ferrule #CAO 63187	
46-597-T-31	250 ohms (120 W) Ferrule, #CAO 63192	
M-37471	Meg-o-max, 80 ohms, 15W, 5%, Non-Ind. CSF 632262-F	
46-597-T-23	125 ohms, 120 W, 9 taps, Ferrule, #CAO 63230	
46-3818-T-5	Meg-o-max, 16,000 ohms, #CSF 63157-F	
46-3818-T-16	Meg-o-max, #CSF 63830-F	
13084T-4	Meg-o-max, 6500 ohms, 6 W, #CSF633318-10P, K-7106845-8	
46-325T-1	Meg-o-max, 32.5 ohms, S 120, SC #3Z6003B2-1	
3953T-16	Meg-o-max, 160,000 ohms, S 120 F, SC #3Z6716-5	
46-597-T-9	2.5 ohms, 120 W, 9 taps, Ferrule	

TBK-17 500 WATT NAVY TRANSMITTERS, 2-18 mc. AVAILABLE: 10 NEW TRANSMITTERS, 5 MOTOR GENERATOR SETS, 220/440 VAC.; 3 MODULATOR UNITS FOR PHONE OPERATION; 50 SPARE OSCILLATOR UNITS. SEND FOR INFORMATION.

*MICROPHONE ELEMENTS

Carbon transmitter element for TS11-J, TS11-L, TS13-E, TS15-A75 ea.
Element for microphone T-24, 30 ohm resistance .95 ea.

APN-1 SPARE PARTS

Switch, #P-255299-5022 for \$3.25
RELAY, #M25377-1\$1.75

*INSULATORS

IN-81 IN-82 IN-84

SCR 578 Transmitters, alone, and complete sets very large quantities available



Magnetrons

Klystrons



*MAGNETRONS

TUBE	FREQ. RANGE	PK.PWR. OUT.	PRICE
2J31	2820-2860 mc.	265 KW.	\$15.00
2J21-A	9345-9405 mc.	50 KW.	\$25.00
2J22	3267-3333 n.c.	265 KW.	\$15.00
2J26	2992-3019 mc.	275 KW.	\$15.00
2J27	2965-2992 mc.	275 KW.	\$15.00
2J32	2780-2820 mc.	285 KW.	\$15.00
2J38 Pkg.	3249-3263 mc.	5 KW.	\$25.00
2J39 Pkg.	3267-3333 mc.	8.7 KW.	\$25.00
2J55 Pkg.	9345-9405 mc.	50 KW.	\$25.00
3J31	24,000 mc.	50 KW.	\$35.00
714AY			\$15.00
720BY	2800 mc.	1000 KW.	\$50.00
720CY			\$55.00
725-A			\$25.00
730-A			\$25.00
KLYSTRONS: 723A/B			\$12.50
707B W/CAVITY	\$20.00	726-A	\$15.00

MAGNETS

For 2J21, 725-A, 2J22, 2J26, 2J27, 2J31, 2J32 and 3J31 Each \$8.00
4850 Gauss, 3/4" bet. pole faces, 3/4" pole diam. \$8.00
1500 Gauss, 1 1/2" bet. pole faces, 1 1/2" pole diam. \$8.00

TUNABLE PKG'D "CW" MAGNETRONS

QK59 2675-2900 Mcs. QK61 2975-3200 Mcs.
QK60 2800-3025 Mcs. QK62 3150-3375 Mcs.
New—\$55 each

3 CENTIMETER PLUMBING

65 deg. twist, 6" long\$10.00
12" section, 45 deg. twist, 90 deg. bend\$6.00
11" straight waveguide section choke to cover. Special heavy construction, silver plated.\$450
5 ft. sections, choke to cover\$14.50
18" flexible sections\$17.50
"E" and "H" plane bends\$12.50
Bulkhead feed thru's\$15.00
DIRECTIONAL COUPLERS, "N" coupling. \$25.00 nominal
DIRECTIONAL COUPLER, waveguide coup-
ling. D-16499 (3 cm) for mounting in "X" band guide\$35.00
TS 108-AP dummy load.\$65.00
"X" BAND calibrated attenuator.\$85.00
SHIELDED KLYSTRON tube mount with rough attenuator\$90.00

TEST SET 159 TPX

Measures frequency between 150 & 200 mc. by heterodyne method. Power of Xmitr can be directly measured. Measures DC voltages up to 500 Volts. Original operation on 110 V. 400 cy. but conversion kit makes it operable on 110 V. 60 cy. new, complete with tubes, crystal, cal. chart, antenna, meter & conversion kit and data for 110 V. 60 cy operation\$29.95

*PRECISION RESISTORS

Type	Range	Tol.	Watts	Type	Range	Tol.	Watts
WM-3	5 ohms	1%			0.1 meg.	1%	
	920	1%			0.12 meg.	1%	
	1,450	1%			0.15 meg.	1%	
	2,230	1%			0.2 meg.	2%	
	5,000	1%			0.22 meg.	2%	
	7,000	1%			0.25 meg.	1%	
	7,500	1%			0.5 meg.	1%	
	8,500	1%			1 meg.	1%	
	10,000	2%		WM-3L	20,000 ohms		
	10,000	1%					
	10,000	1%					
	17,000	2%		WM-4L	50 ohms	1%	
	30,000	1%			75	1%	
	33,000	2%			82	1%	
	35,000	1%			120	1%	
		1%			125	1%	
		1%			128	1%	
		1%			150	1%	
		1%			200	1%	
		1%			250	1%	
		1%			468	1%	
		1%			800	1%	
		1%			1,100	1%	
		1%			25,000	1%	
		1%			35,000	1%	
		1%		WM-4L	0.25 meg.	1%	
		1%		WL	18 ohms	1%	
		1%		XL	300	1%	
		1%		TM	10	1%	
		1%		TM-1	1,000	1%	
		1%		X	10.1	1%	
		1%		X	43.5	1%	
		1%		X	430	1%	
		1%		X	1,900	5%	
		2%		X	4,300	2%	

Note: Type with suffix "L" have 3" wire leads, otherwise they have solder lug terminals.

*MFG'S QUANTITIES AVAILABLE

*PLUGS AND CONNECTORS

PART NO.	DESCRIPTION
PL 148A-2Z7226-148A	Female Plug, ARC type, 3 hole
Jones #P-302-AB-2Z7228.4	Bendix #A102811, Male "Jones" (Less Cover)
2Z7228-4	ES-691210-2, (RC-103-A), Male Chassis Plug, Sm. Banana, 3 Pins, Special, on Bakelite Sheet
SO 43-2Z8743 (SCR 283)	Male Chassis Plug, 8 Medium Size, Banana Pins, 1 1/2" FD, Some Painted Black, Some unpainted
2Z7114 51-Jones	#P-101/4, Male Connector Single Contact
R & S Everlock	Male Plug, 5 Pin, W/Cable Clamp
PL 182-10H/258-B	2Z7226-182, NAF 68925-2, Male Plug, 7 Pin, Bakelite, Tube Base type W/Key
PL 174-10/H258-B	NAF-68925-2, Same As Above, but w/Metal Cover
Cannon WK621C-3/4	-2Z3067-13, Female Plug, 6 holes W/Cable Clamp, 3/4" FD
Amphenol AN3064-12	-Cable Ferrule 1 1/2" FD
Amphenol-AN306416	Cable Ferrule 1 1/2" FD
Amphenol -37-5103-22-85	-Female Plug 2 hole Threaded Both Ends 1 1/2" FD
Amphenol-97-3100-22-8	-Female Chassis Receptacle 2 hole 1 1/2" FD
Amphenol AN-3046-8	-Cable Ferrule 11/16" FD
3Z9856-3	-CD618A, Special Insert type "6 Volt Only," 3/4" Dia. 9/16H
FT 137-2Z387	-Right Angle Cable Feed & Clamp for 191 type Plug 1 1/2" FD
U-15/U-2Z 7250-15 (ARC-3)	-Female Plug, 16 holes, Plated ARC type, Cable Clamp
2Z7412-12-7027	-(SCR274N), Male Chassis Receptacle, 18 Pins ARC type
COA-1	ES-677556-2, Transmission Line Connector
2Z-7227-10	-Female Plug Ass. Chassis Mtg., ARC type 3 hole
AN-3057-16	-2Z2636-2, 4K103589, M289, Cable Clamp Amphenol 1 1/2" FD
AN3102-14S-2P	-Male Chassis Plug 4 Pin 13/16" FD
GK-12-21C-1/2	-Female Cable Connector 12 hole, Cannon 1" FD
PL 123	-Female Plug 2 hole Threaded Both Ends 15/16" FD
AN3106-14S-2S	-PL-P-257, 2Z7226-P-257, Female Cable Plug 4 hole Amphenol 5/8" FD
AN-3102-14S-5A	-Male Chassis Plug 5 Pin 7/8" FD
AN-3102-16S-1P	-FD20443-1, Male Chassis Plug 7 Pin Amphenol 1" FD
UG21U	UG2290-21-(Type N) Male Cable Connector Original "Amphenol"
AN3108-28-12S	-Female Cable Plug 28 hole, Right Angle Harwood 1 1/2" FD Matches BA10251-3 Below
BA10251-3	-Male Chassis Receptacle Hubbell, 26 Pin 1 1/2" FD, Matches AN3108-28-12S Above
2Z7116.3	WK-6-32S-Male Chassis Receptacle 6 Pin Cannon 13/16" FD, Matches 2Z7242-85 Below
2Z7242-85	WK-6-23 3/4" B-Female 6 Pin Cable Plug, Right Angle 3/4" FD, Matches 2Z7116.3 Above, Cannon
2Z7171	PL-71-Female Cable Plug 3 hole Cannon Semi Heavy W/Right Angle Cable Feed
2Z7242-88	-WK-6-21 3/4" B, A30088, Female Cable Plug 6 Hole Cannon, 3/4" FD
2Z3067-13	-WK-6-21C%, Similar to above, but less threaded End, with Cable clamp, Cannon
AN3108-36-15S	-Female Cable Plug, 35 hole, Rt. Angle, Monowatt, 2" FD
AN3102-20-1P	-Male Chassis Receptacle, 14 Pin Amphenol 1 1/2" FD (Cable Plugs for Above P1P256, AN3106-20-27S)
PLP256	AN31062027S - 2Z7226-256.2, Female Cable Plug 14 hole, 1" FD, "Amphenol"
UG25/U	-Female type N chassis receptacle

101-A TWO-WIRE APPLIQUE

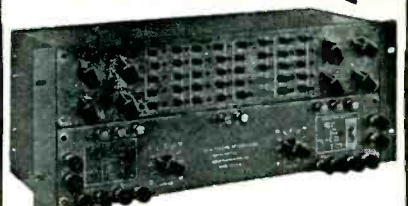

Provides necessary balancing facilities for four wire repeater when used on two wire lines which may be voice-frequency telephone lines of open wire, or non-loaded or loaded cable. Std. 1 1/2" channel iron rack mtg. Price, new, complete with tech manual, \$54.00

EE-89A REPEATER

Extends range of field telephone apparatus, such as EE-8 up to 25 miles, when inserted in a line. New, with spare tube and instruction manual, less standard type batteries\$21.50

BC 686 LINE AMPLIFIER

With magneto ringer, 3-tube 25L6 amplifier. For local point-to-point telephone operation, remote operation of Phone Emit. remote operation of receiver output, monitoring facility. Requires only 24 vdc for tube "B" plus supply for full operation. New, less tubes, in wooden chest\$18.50
Per pair for 2-way pt-to-pt operation\$35.00
Telephone switchboard lamp holders: 10 imp holders per strip\$4.25
LAMP CARDS FOR TELEPHONE SWITCH-BOARDS: GREEN, RED, WHITE.\$.05 ea.

U. S. Army red and white star cluster flares, with cartridges. Types M52-A1 and M-18-A1. New, export packed in wooden carrying cases. 60,000 available.

131-E

Liberty St.
New York, N.Y.

ALL MERCHANDISE GUARANTEED. MAIL ORDERS PROMPTLY FILLED. ALL PRICES, F.O.B. NEW YORK CITY. SEND MONEY ORDER OR CHECK. SHIPPING CHARGES SENT C.O.D. RATED CONCERNS SEND P. O.

COMMUNICATIONS EQUIPMENT CO.

Cable
"Comsup"
Ph. Digby 9-4124
MR. CHAS. ROSEN

**RELAYS
MANUFACTURERS QUANTITIES**

Stock No.	Contacts	Coll Rating	Coll Res. (Ohms)	Mfr. & No.
138TBD4	DPDT (8 amp)	24-28 vdc	170 ohms	G.E.: CR2791B100F3
4T-1	SPDT	28 vdc	175	G.E.: CR2791B100CS
430T-1	3PDT	24-28 vdc	175	G.E.: CR2791B100J3
682T-1	4PST	24 vdc	180	G.E.: CR2791G100K4
12058T-1	DPDT, SPST (NO)	12 vdc	44	Leach: 1087-490 (antenna relay)
2535	DPDT	22-28 vdc	160 ohms	Leach: 1077 BF (antenna relay)
13520T-2	SPST (NO)	28 vdc	250	Allied Box: 48
46-800-1	DPST (NO)	14 vdc	85	Price: X-20-A
4352T-1	3PDT	24-28 vdc	250	Allied: DDX-3
13166T-1	SPST	24-28 vdc	2400	G.M.: #12917-1
138T-2A	DPDT	24 vdc	250	Allied: BO-635
2243-T-1	3PDT (10 amps)	26 vdc	280	Allied: KS 5910-L11
1619T-2	DPDT	28 vdc	280	Allied: BO6D35
611T-1	SPST (NC) (2 amp)	75 ma.	60	Allied: KS 5862
41115T-1	DPDT	20-30 vdc		Dunco: 50XBX103
192T-1	DPDT	10-14 vdc		Dunco: 100ABX103
461711T1	DPDT (6 amps)	12 vdc		Dunco: CX3190 B (latching type)
417T-2	SPDT	10-12 v, 60 cy.	125	Dunco: CX2120
4118T-7	DPDT	27.5 vdc	400	Allied
1640T-1	DPDT	9-14 vdc		Allied: KS 5819 LO8
833T-1-6	DPDT	24 v, 60 cy.	50 ohms	G.E.: CR2791C104B28 (high speed)
3W46831	SPDT	24 vdc		

MINIATURE RELAYS

Stock No.	Contacts	Coll Rating	Coll Res. (Ohms)	Mfr. & No.
2608T-1	4PST (NO)	24-28 vdc	300 ohms	Clare: A16280
2469T-1	SPDT	22-28 vdc	300	Clare: BA10059-3
4117T-1	SPDT	24-28 vdc	300	Philleo: 452-1086
4121T-2	DPDT	24-28 vdc	300	Philleo: 452-1148
1452T-1	DPDT	24-28 vdc	300	Am. Tot.: A-8045
295T-1	DPST (NO)	18-25 vdc	300	Allied: CA-5
4118T-A	SPDT	24-28 vdc	300	Allied: C-4
690T-1	SPDT	24-28 vdc	300	Philleo: 452-12 98
4118T-6	SPDT	24-28 vdc	300	Philleo: 452-1086
4121T-1	SPDT	24-28 vdc	300	

***ARC-3 EQUIPMENT MINIATURE RELAYS**

Stock No.	Contacts	Coll Rating	Coll Res. (Ohms)	Mfr. & No.
142R	SPDT, DPST	28 vdc	300 ohms	RBM 55342
83R	6PST (NO)	22-28 vdc	300	RBM 55528
126-R	SPST	22-28 vdc	300	RBM 55251
167R	DPDT, DPST (NO)	22-28 vdc	300	RBM 55531
149R	SPDT, SPST (NO)	22-28 vdc	300	RBM 55526
927T-4	SPDT	24-28 vdc	300	RBM 55836

BATHUB CAPACITORS

Stock No.	Mfr. & No.	Description
3DA100-2311	#16-NBN	3 X .1 MFD @ 400 VDC-Top Lugs
3DKA-100-169		3 X .1 MFD @ 600 VDC-Top Lugs
18B-95		3 X .1 MFD @ 600 VDC-Top Lugs
3DA-100-124-3		3 X .1 MFD @ 600 V-Side Lugs
18B83		2 X .1 MFD @ 600 VDC-Bot. Lugs
3DA-100-110		2 X .1 MFD @ 600 VDC-Bot. Lugs
3DA-500-373		.5 MFD @ 600 VDC-Side Lugs
3DA500-87		3 X 5 MFD @ 100 VDC-Side Lugs
18B-84		2 X .1 MFD @ 600 VDC-Side Lugs
46-1951T-9		2 X .1 MFD @ 600 VDC-3 Side Lugs
CP50B4EF104V		CP50B4EF104V
2C4229-2	1574	2 X .1 MFD-2 Bot. Lugs
46-1311-107	P9723	3 X .1 MFD @ 600 VDC-3 Bot. Lugs-CSF-48709-A20
3DA-250-172		2 X .25 MFD @ 400 VDC-Side Lugs
3DA-100-423		3 X .1 MFD @ 600 VDC-Top Lugs
1951T-5	#9453	2 MFD @ 400 WVDC-2 Side Lugs
46-1951T-18		3 X .1 MFD @ 400 VDC-3 Side Lugs
CP50B5EE104B		CP50B5EE104B
4180T-2	430TR11	.1 MF @ 400 VDC-2 Top Lugs 1 CD-1066-11V
46-1951T-6		2 X .1 MF @ 600 VDC-3 Top Lugs
CP51B4EF104V		CP51B4EF104V
45B-4		.1 MFD @ 600 VDC-Side Lugs
3DA250-29		.25 MFD @ 600 VDC-Top Lugs
3DA100-97-27	RLO-650	.5 MFD @ 600 VDC-2 Side Lugs
3DA-500-292		.5 MFD @ 120 VDC-2 Top Lugs
18B-97		.1 MFD @ 600 VDC-1 Side Lug
3D275		4 MFD @ 50 VDC-2 Side Lugs
3DA-1-230-1	230 M	1 MFD @ 400 VDC-1 Side Lug
18B-44		3 X .1 MFD @ 600 VDC-3 Bot. Lugs
CP52B5EF104M		CP52B5EF104M
3D9005-2D	8A31231-C2	.5 MFD @ 200 VDC-2 Side Lugs
1W10540-2	CSF481391-10	.05 MFD @ 600 VDC-2 Top Lugs
3DA500-30		.5 MFD @ 600 VDC-2 Side Lugs
1699T-1	630 R08-C	2 X .25 @ 600 VDC-3 Side Lugs
18B-60		3 X .1 MFD @ 600 VDC
CGF4B713B10		CGF4B713B10
3DA100-42	#DYRT-6111	3 X .1 MFD @ 600 VDC-3 Top Lugs
3DB1A25-2		1.25 MFD-100 VDC
46-1081-1		2 X 0.1 MFD-600 WVDC-3 Bot. Lugs
CP52B4EF104		CP52B4EF104

**HEADSET PLUGS and JACKS
PLUGS PL-54 JK-26**

*M.F.G.'S QUANTITIES AVAILABLE



***LEAR AVIATION POWER UNITS**
24 vdc drive, 90:1 gear ratio, High power. Originally designed for landing gear retraction. Bicycle type sprocket for multi-purpose drive. Large quantity available. \$16.50

***OIL CAPACITORS (STANDARD BRANDS)**

Stock No.	Description
46-1384T-1	#25F649 0.5 mfd-2,000 vac. 180 cy.-2 standoffs (M7471333-1) 5" x 4 1/2" x 3 1/2"
13036T-2	26F433 0.2 mfd-10 kvdc-(CG-481703) 3" x 0.1 mfd-600 vdc-3 bot. lugs. 1 1/2" x 2 1/2" L x 1 1/2"
W-46988-1	CA255 2.0 mfd-@ 600 vdc-bot lugs, rd. cam 2" diam. x 3 1/2" H./w/mtg. bracket
W-2381-"17"	AX-1089 3" x 0.5 mfd-500 vdc, B34584 rect. can, w/mtg. bracket-3 top lugs, 2 1/2" H x 1 1/2" sq.
C5E66	XEM 0.5 mfd-600 vdc, XEM R B W 6, C S L-481921-10, KS8546/M-2 bot. lugs w/mtg. brack. 1 1/2" x 1 1/2" x 1 1/2"
14F191	.1 mf @ 10,000 vdc, CP70D1FS104K
26F344	.005 x .005 x .01 mf @ 10 kvdc
25F585-G2	.06 mf @ 15 kv
25F774	.1 @ 7000 vdc
23F299	1 mfd-500 vdc-upside down-2 lugs, 2" H x 1 1/2" W x 1 1/2" W
C-5D-46	616MB 0.1 mfd-600 vdc-2 bot-top lugs, 1 1/2" x 1 1/2" x 1 1/2"
C-5K-8	618CT 0.25 mfd-400 vdc, CRV481176, P720555-1, 3 1/2" x 1 1/2" x 1 1/2"
C5D-4-6	616M 0.1 mfd-600 vdc-2 bot. lugs, 1" x 1 1/2" x 1 1/2"
46-815 "E"	616M 0.25 mfd-400 vdc, CRV481176, P720555-1, 3 1/2" x 1 1/2" x 1 1/2"
3DA50-32	#5414 3 x .05-300 vdc
46-167T-30	#2009M 0.5 mfd-1500 vdc, 224365 S01, 4" x 1 1/2" x 1 1/2"
2281T-1	7030-19A 1.0 mfd-1500 vdc, 4 1/2" x 1 1/2" x 1 1/2"
14B-282	1 1/2" x 1 1/2" x 1 1/2"
13772T-1	#2ZF41 0.5 mfd-1000 vdc, CP70E1FG504K, 2 1/2" x 1 1/2" x 1 1/2"
W-775	2 x 2 mfd-500 vdc, 4 top lugs, 3 1/2" x 2 1/2" x 1 1/2"
46-167T-44	RYS 2 mfd-1000 vdc, 1 20%, K7108152-P2, 3 1/2" x 1 1/2" x 1 1/2"
(Vlt. "Q")	2 x 2 mfd-600 vdc, 3 1/2" x 2 1/2" x 1 1/2"
829 "C"	PO2 2.0 mfd CA-59
13759T-5	25F805 1.0 mfd, 400 cy., @ 250 vac, 2 1/2" x 2 1/2" x 1 1/2"
8A106494	SA106494 3" x 0.5 mfd-1000 vdc, 2 1/2" x 1 1/2" x 1 1/2"
8A106495	SA106495 2.0 mfd-1000 vdc, 3 1/2" x 1 1/2" x 1 1/2"
8032-"D"	2 mfd-600 vdc, 1 1/2" diam. x 3"
47-167-43	2509M 0.1 mfd-2500 vdc, CP70E1EK104K, 2 1/2" x 1 1/2" x 1 1/2"
46-582T-2	Co.6GA200 2 mfd-600 vdc, 1 1/2" diam. x 3" L
W-444 "F"	AX-1169MSB 3" x .67 mfd-90 vac-3 lugs, 3 1/2" x 1 1/2" x 1 1/2"
3DA250-207	55908 0.25 mfd @ 400 vdc, upright, tubular 1 1/2" dia. x 2" L
46-1308-T6	RO3 2.0 mfd-600 vdc, CAW48777, 2 1/2" x 1 1/2" x 1 1/2"
47-167T-11	25F813 2 x .1 mfd-4800 vdc, type EBK, 3 1/2" x 2 1/2" x 1 1/2"
13752T-13	#25F509G2 0.1 mfd-6000 vdc, CG481941-10, 3 1/2" x 3 1/2" x 1 1/2"
46-167-T-76	2009 0.5 mfd-1500 vdc

CERAMICON CONDENSERS
\$7.50 per 100

3 mmf	±5%	67 mmf	±20%
5 mmf	±5%	100 mmf	±5%
4 mmf	±5 mmf	115 mmf	±2%
8.5 mmf	±5 mmf	120 mmf	±5%
11 mmf	±5%	240 mmf	±3%
15 mmf	±2.5 mmf	250 mmf	±15-30%
48 mmf	±2%	500 mmf	±15-30%
50 mmf	±20%	1000 mmf	±5%
60 mmf	±3%		

***Silver-Mico Button Capacitors (Erie, Centralab) \$9.50 per 100**

185 mmf	±2.5 mmf
175 mmf	±2.5 mmf
500 mmf	±10%

***ELECTROLYTIC CAPACITORS**

1986T-2	25-25 mfd-50 vvdc
46-1814T-2	20 mfd-25 vdc, K-7104527
46-1909	D1223 30 mfd-50 vdc, #2C6494A/C6
W-173-A	2500 mfd-3 vdc, 2 x 40 mfd-150 vdc, 20 mfd-25 vv-octal plug-in

Build YOUR OWN TEST EQUIPMENT

Heathkit ELECTRONIC SWITCH KIT DOUBLES THE UTILITY OF ANY SCOPE

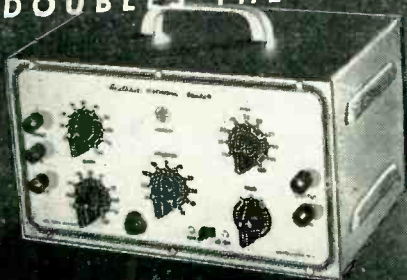

\$34.50

Gives two separately controllable traces with individual inputs on any scope. See both the input and output traces, locate distortion, phase shift, etc., immediately. Individual gain controls and positioning control. Coarse and fine sweeping rate controls. Complete Heathkit matches others, with 5 tubes. All metal parts are punched, formed and cadmium plated. Complete with tubes, all parts, detailed blueprints and instructions. Shipping Wt. 13 lbs.
Nothing ELSE TO BUY

HEATHKIT CONDENSER CHECKER KIT

\$19.50

Nothing ELSE TO BUY



A condenser checker anyone can afford to own. Measures capacity and leakage from .00001 to 1000 MFD on calibrated scales with test voltage up to 500 volts. No need for tables or multipliers. Reads resistance 500 ohms to 2 megohms. 110V 60 cycle transformer operated complete with rectifier and magic eye indicator tubes. Easy quick assembly with clear detailed blueprints and instructions. Small convenient size 9" x 6" x 4 3/4". Wt. 4 lbs.

HEATHKIT SIGNAL GENERATOR KIT



\$19.50

NOTHING ELSE TO BUY

Every shop needs a good signal generator. The Heathkit fulfills every servicing need, fundamentals from 150 Kc. to 30 megacycles with strong harmonics over 100 megacycles covering the new television and FM bands. 110V 60 cycle transformer operated power supply. 400 cycle audio available for 30% modulation or audio testing. Uses 6SN7 as RF oscillator and audio amplifier. Complete kit has every part necessary and detailed blueprints and instructions enable the builder to assemble it in a few hours. Large easy to read calibration. Convenient size 9" x 6" x 4 3/4". Wt. 4 1/2 lbs.

HEATHKIT SIGNAL TRACER KIT

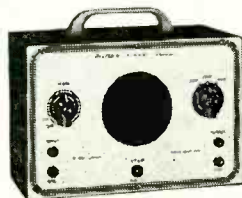

\$19.50

Nothing ELSE TO BUY

Reduces service time and greatly increases profits of any service shop. Uses crystal diode to follow signal from antenna to speaker. Locates faults immediately. Internal amplifier available for speaker testing and internal speaker available for amplifier testing. Connection for VTVM on panel allows visual tracing and gain measurements. Also tests phonograph pickups, microphones, PA systems, etc. Frequency range to 200 Mc. Complete ready to assemble. 110V 60 cycle transformer operated. Supplied with 3 tubes, diode probe, 2 color panel, all other parts. Easy to assemble, detailed blueprints and instructions. Small portable 9" x 6" x 4 3/4". Wt. 6 pounds. Ideal for taking on service calls. Complete your service shop with this instrument.

HEATHKIT SINE AND SQUARE WAVE AUDIO GENERATOR KIT

The ideal instrument for checking audio amplifiers, television response, distortion, etc. Supplies excellent sine wave 20 cycles to 20,000 cycles and in addition supplies square wave over same range. Extremely low distortion, less than 1%, large calibrated dial, beautiful 2 color panel, 1% precision calibrating resistors, 110 V 60 cycle power transformer, 5 tubes, detailed blueprints and instructions. R.C. type circuit with excellent stability. Shipping weight 15 pounds.



\$34.50

Nothing ELSE TO BUY

THE NEW HEATHKIT VACUUM TUBE VOLTMETER KIT

The most essential tool a radio man can have, now within the reach of his pocketbook. The Heathkit VTVM is equal in quality to instruments selling for \$75.00 or more. Features 500 microamp meter, transformer power supply, 1% glass enclosed divider resistors, ceramic selector switches, 11 megohms input resistance, linear AC and DC scale, electronic AC reading RMS. Circuit uses 6SN7 in balanced bridge circuit, a 6H6 as AC rectifier and 6 X 5 as transformer power supply rectifier. Included is means of calibrating without standards. Average assembly time less than four pleasant hours and you have the most useful test instrument you will ever own. Ranges 0-3, 30, 100, 300, 1000 volts AC and DC. Ohmmeter has ranges of scale times 1, 100, 1000, 10M and 1 megohm, giving range .1 ohm to 1000 megohms. Complete with detailed instructions. Add postage for 8 lbs.



\$24.50

Nothing ELSE TO BUY

HEATHKIT FM AND TELEVISION SWEEP GENERATOR KIT

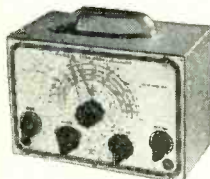

\$24.50

NOTHING ELSE TO BUY

THE BASIC FM AND TELEVISION SERVICE INSTRUMENT

At the lowest cost possible, anyone can now service FM and television receivers. The Heathkit sweep generator kit operates with oscilloscope and covers all necessary frequencies. A few pleasant hours assembling this kit puts any organization in position to share the profits of the FM and TV boom.

Every part supplied — grey crackle cabinet, two color calibrated panel, all metal parts punched, formed and plated. 5 tubes, complete detailed instructions for assembly and use. Shipping weight 6 lbs.

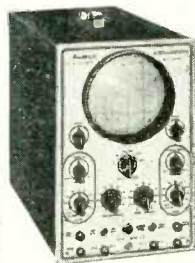

The NEW 1948 HEATHKIT 5 INCH OSCILLOSCOPE KIT

\$39.50

NOTHING ELSE TO BUY

New improved model of the famous Heathkit Oscilloscope. Building an oscilloscope is the finest training for television and newer servicing technique and you save two-thirds the cost. All the features and quality of instruments selling for \$100.00 or more. Supplied complete with cabinet, two color panel, 5B1 tube, 2 5Y3 tubes, 2 6SJ7 tubes and 884 sweep generator tube. Power transformer supplies 1000V negative and 350 volt positive. Sweep generator 15 cycles to 30 M. cycles. Has vertical and horizontal amplifiers. Oil filled filter condensers for long life. Complete blueprints and instructions included.

The HEATH COMPANY
BENTON HARBOR 14, MICHIGAN



Buy HEATH SURPLUS Now!

ALL QUANTITIES LIMITED SUBJECT TO PRIOR SALES

APN/1 RADIO ALTIMETERS



NO. 200. The last chance to get a complete new 14 tube radio altimeter. Contains 420 Mc. transmitter and receiver, power supply, range switches, two antennas, meter indicator, all plugs and instruction manual. This unit makes excellent amateur station as it is right in the band. Shipped in original export crate. Weight 87 lbs.

\$34.50

G.E. BC 375 TUNING UNIT

NO. 203. Model TU10B covers 10 Mc. to 12.5 Mc. New complete with aluminum cabinet. The best buy of surplus. Over \$30.00 worth of new variable condensers, coil, dials, switches, etc. Add postage for 20 lbs.



\$2.49

G.E. 50 AMP CIRCUIT BREAKER

NO. 204. New General Electric 50 Amp 220 Volt AC circuit breakers. 100 Amp when used on 110V. Add postage for 4 lbs.



\$2.95
EACH
3 FOR \$7.50

BC 347 AIRCRAFT INTERPHONE AMPLIFIER

NO. 205. Interphone amplifier contains 6F8 tube, Oncner transformers, diagrams, etc. in aluminum cabinet. Add postage for 4 lbs.



\$2.95

274N COMMAND SET ACCESSORIES

NO. 238. 5" PM Speaker with output transformer matching head-phone output. \$2.80
NO. 239. Dual receiver rack FT277A with connecting plugs. \$1.00
NO. 240. Single transmitter rack FT234A. \$1.00
NO. 241. Spine shaft for tuning command receivers. Allows use of regular tuning knob on BC 453-4-5 receivers. \$.39



BC 451 CONTROL BOX
NO. 236. Control box for 274N transmitters. Contains proper c-voice switch, 4 channel switch, power switch, mike jack and telegraph key. Add postage for 2 lbs. \$1.95

METER SPECIAL

NO. 237. Brand new DeJur Model 312 0-800 M.A. D.C. Square 3" 0-10 M.A. basic meter with built in shunt. Probably the best buy ever offered in a surplus meter. Shipping Weight 1 lb. \$2.95



A-62 ARMY PHANTOM ANTENNA

NO. 206. Contains tuning condenser, coil, resistors, tuning dial, tuning indicator, binding posts, steel case, useful for building amateur transmitter. Add postage for 8 lbs. \$1.95



BENDIX MR9C COMPASS CONTROL UNIT

NO. 207. Tuning and control unit for Bendix MN 26 radio compasses contains tuning dial, band switch, crystal switch, AVC switch, volume control, fuses, phone jacks, etc. Shipping Weight 5 lbs. \$9.50

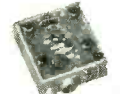

BC731 CONTROL BOX

with Weston Model 476 AC Voltmeter
NO. 208. Excellent buy in motor control box. Size 8" x 10" x 5 1/2". Contains Weston 0-150V. AC 3 1/2" voltmeter, motor starting switch, 28 fuses all 30 Amp 110V. and 8 fuse holders. Fuses and holders alone worth the price. Shipping Weight 18 lbs. \$7.95



BC 645 GENERAL ELECTRIC TRANSCEIVER

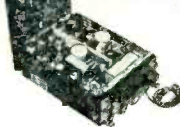

NO. 201. Complete 15 tube transmitter-receiver. Ideal for new citizens band 460 Mc. for communication between office and car, home, boat, etc. Conversion article in August ELECTRONICS Magazine. Brand new in original G.E. cartons with tubes. Add postage for 25 lbs.

\$19.50 ... 2 for \$35.00

ACCESSORIES FOR BC 645
PE101C Dynamotor for car use \$ 3.95
110V 60 Cycle Power Supply for home or office use. \$14.50

T32 TABLE MICROPHONE

NO. 210. One of the Army's best. Built by Kellogg, ideal for factory call system, public address, amateur use. Brand new in original cartons. Add postage for 5 lbs.



\$2.95

MINIATURE ELECTRIC MOTOR



NO. 211. Tiny Delco motor only 1" x 1 1/4" x 2" 10,000 RPM. Operates from 6 to 24 V. Excellent for models. Add postage for 1 lb. \$2.95

\$2.95

P. E. 103
6 VOLT

DYNAMOTOR

NO. 212. Dynamotor only from PE 103 power supply. Input 6 or 12 Volts, output 500 Volts at 160 MA. Brand new original cartons. Shipping Weight 29 lbs. \$5.95



\$5.95



G.E. BC 306 ANTENNA TUNING UNIT

NO. 213. An ideal dynamotor for mobile operation in taxicabs, police cars, sound systems and amateur stations. Supplies above voltage from 12 Volts or 500V. at 350 MA from 6 Volts. Complete with starting relay, and fuses. New. Our Dynamotor A. Shipping Weight 72 lbs. \$5.95

\$5.95

DM-36 DYNAMOTOR

NO. 215. Western Electric 24 Volt input, 220V. at 60 MA out. With filter assembly. Shipping Weight 6 lbs. \$2.95

\$2.95

G.E. BC 306 ANTENNA TUNING UNIT

NO. 231. Matches any aerial to 150 Watt transmitter, used on BC 375. Brand new. Add postage for 20 lbs. \$2.95

\$2.95

W.E. BC 456 MODULATOR

NO. 217. Modulator for 274N command transmitters contains 3 husky relays, 3 tubes, VR150, 1215 and 1625. Brand new. Add postage for 11 lbs. \$3.95

\$3.95

BE 77 TELETYPE TEST SET

NO. 218. Contains zero center voltmilliammeter, switches, relays, voltage divider resistors, neon indicator, etc. Excellent foundation for radio tester. Shipping Weight 10 lbs. \$7.95

\$7.95

BENDIX MN 20E DIRECTION FINDER LOOP

NO. 219. Ring type loop excellent for use on boat or aircraft. Extremely rugged construction. Low impedance manual type. Add postage for 8 lbs. \$9.95 EACH



LP 18C DIRECTION FINDER LOOP

NO. 220. Motor driven streamline pod type loop used on automatic direction finders. Has Selsyn transmitter and motor, fits most military direction finders. Add postage for 20 lbs. \$14.50 EACH

\$14.50 EACH

KIT SPECIALS

POTENTIOMETERS
NO. 232. Kit of 10 excellent shaft type potentiometers good variety. \$1.95
SOCKETS
NO. 233. Kit of 20 high quality sockets several different types. \$1.00

RCA NAVY COMMUNICATION RECEIVER

NO. 202. The last of these beautiful RCA sets. Covers 195 Kc. to 9.1 Mc. continuously. Supplied complete with tubes, control box, tuning unit, 24 Volt dynamotor, band change motor, plugs and circuit diagram. Superheterodyne circuit covers aircraft, broadcast, short wave, marine, foreign broadcasts. Has sharp or broad I.F.'s B.F.O., etc. Shpg. Wt. 30 lbs. \$29.50

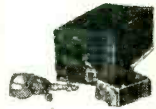

\$29.50

PE 125 TRANSMITTER POWER SUPPLY



NO. 223. Operates from 12 to 24 Volts and supplies 500 Volts at 160 MA. Extremely rugged construction used in Army tanks. Complete with fuses - relays - filters, etc. Ideal for boats. Shipping Weight 73 lbs. \$12.95

\$12.95

FM PUSH BUTTON TUNER

NO. 224. Brand new ten push button tuning assembly from Army FM receiver. Contains 4 gang 100 MMF silver plated tuning condensers. Add postage for 10 lbs. \$2.50 EACH



RG 8/U FLEXIBLE COAXIAL CABLE

NO. 225. Standard television lead in 52 ohm. Any length up to 1,000 ft. Add for postage. 4¢ PER FOOT



POWER TRANSFORMER Specials

NO. 226. Primary 117V. 60 cycle. Secondaries supply 746 V.C.T at 220 MA, 6.3V. at 4.5 A., and 5V. at 4A. Will handle 13 tube radio receivers. Supply is limited, order early. Shipping Weight 11 lbs. each. \$3.95 ... 3 for \$9.95

OUTPUT TRANSFORMER

NO. 227. Push pull 6V6's to 6-8 ohm voice coil excellent characteristics. 3 for \$1.95

TRANSFORMER TRANSFORMER

NO. 228. The transformer for Transmitter Power Supply, 600 Volt at 200 MA and 4 Amp. filaments of 3 to 24 Volts. Also 5 Volts at 4 amperes for rectifier. Shipping Weight 12 lbs. \$9.50

MILITARY POWER TRANSFORMERS

NO. 229. Convert your military receivers without rewiring the filament. "A" type supplies 500 VCT at 50 MA, 5V. at 2A. and 24V. at 1/2 A. "B" type supplies 500 VCT at 50 MA, 5V. at 2A. and 12V. at 1 Amp. State whether A or B type desired. Shipping Weight 4 lbs. \$2.95



HOME WORKSHOP GRINDER KIT

NO. 230. Easily assembled 110V AC or DC ball bearing fully enclosed motor from Army surplus dynamotor. Purchaser to make simple changes and shaft extensions, detailed instructions and all parts supplied. Motor approximately 5,000 R.P.M. Ideal for tool-post grinder, flexible shaft tool, model drill press, saw. Shipping Weight 6 lbs. \$3.95



\$3.95

HEARING AID HEADPHONES

NO. 216. The Army's best - eliminate flat ears and outside noise. Complete with transformer for conversion from low to high impedance. With cord and plug complete. Add postage for 1 lb. \$1.00

TELEVISION CONDENSERS

NO. 221. Tube triple .2 MFD 4000 V.D.C. Filter used on Army radar. Ideal filter for H.V. television set. Add postage for 3 lbs. \$3.95
NO. 222. Capacitor .25 MFD 6000 V.D.C. Porcelain insulated, an outstanding buy for high voltage filters. Add postage for 3 lbs. \$3.95



\$1.00

HOW TO ORDER • • • GIVE PART NUMBER AND DESCRIPTION • • • ADD POSTAGE FOR WEIGHT SHOWN. NO ORDERS UNDER \$2.00 • • • WE WILL SHIP C.O.D.



The HEATH COMPANY

DEPT. E ... BENTON HARBOR, MICHIGAN

RADIOMEN'S HEADQUARTERS ✨ WORLD WIDE MAIL ORDER SERVICE !



1949 MODEL MUTUAL CONDUCTANCE TUBE TESTER with new 9 pin socket to handle all future tube developments **\$49.95**
 No possibility of good tubes reading "bad" or bad tubes reading "Good" as on dynamic conductance testers or other ordinary emission testers. Attractive panel and case equal to any on the market in appearance . . . Large 4 1/2" meter . . . Calibrated Micromho scale as well as a Bad-Good scale . . . Front panel fuse . . . Individual sockets for all tube base types—voltages from .75 volts to 117 volts and complete switching flexibility allow all present and future tubes to be tested regardless of location of elements on tube base . . . Indicates gas content and detects shorts or opens on each individual section of all local, octal and miniature tubes including cold cathode, magic eye and voltage regulator tubes as well as all ballast resistors. Name of the nationally kn reading "Good" as on dynamic conductance testers or other
 Model "C"—Sloping front counter case . . . **\$49.95**
 Model "P"—Handsome hand-rubbed portable case . . . **\$4.95**
 Built-in roll chart with either of above \$5.00 extra.

GENERAL ELECTRIC RT-1248 15-TUBE TRANSMITTER-RECEIVER

TERRIFIC POWER—(20 watts) on any two instantly selected, easily pre-adjusted frequencies from 435 to 500 Mc. Transmitter uses 5 tubes including Western Electric 316 A as final. Receiver uses 10 tubes including 855's, as first detector and oscillator, and 3-7H7's as IF's with a 4 slug-tuned 40 Mc. IF transformers, plus a 7117, 7E6's and 7F7's. In addition unit contains 8 relays designed to operate any sort of external equipment when actuated by a received signal from a similar set elsewhere. Originally designed for 12 volt operation, power supply is not included, as it is a cinch for any experimenter to connect this unit for 110 AC, using any supply capable of 400 DC at 135 FA. The ideal unit for use in mobile or stationary service in the Citizen's Radio Telephone Band where no license is necessary. Instructions and diagrams supplied for running the RT-1248 transmitter on either code or voice in AM or FM transmission or reception, for use as a mobile public address system, on 80 to 110 Mc, as an FM broadcast receiver, as a Facsimile transmitter or receiver, as an Amateur Radio Television transmitter or receiver for remote control relay hookups, for Geiger-Mueller counter applications. It sells for only \$29.95 or two for \$53.90. If desire for marine or mobile use the dynamotor which will work on either 12 or 24V DC and supply all power for the set is only \$15.00 additional.

BRAND NEW

BC-221 FREQUENCY METERS with calibrating Crystal and calibration charts. A precision frequency standard that is useful for innumerable applications for laboratory technician, service man, amateur, and experimenter at the give away price of only \$75.00.

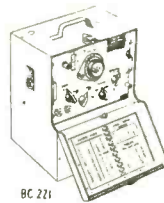

BUFFALO RADIO SUPPLY, ONE OF AMERICA'S LARGEST ELECTRONIC DISTRIBUTORS, IS IN A POSITION TO SUPPLY MOST OF THE REQUIREMENTS OF FOREIGN PURCHASERS, DIRECTLY FROM ITS GIGANTIC STOCKS OR THOSE OF ITS AFFILIATES. EXPORT INQUIRIES ARE SOLICITED BOTH FROM EXPORT HOUSES AND FROM FOREIGN GOVT. PURCHASING COMMISSIONS HERE AND ABROAD. EXPENSE CAN BE REDUCED AND REQUIREMENTS FILLED WITH A MINIMUM OF DELAY BY CONTACTING BUFFALO RADIO SUPPLY INITIALLY.

GENERAL ELECTRIC 150 WATT TRANSMITTER

Cost the Government \$1800.00 • Cost to You— BRAND NEW — \$100.00

This is the famous transmitter used in U.S. Army bombers and ground stations, during the war. Its design and construction have been proved in service, under all kinds of conditions, all over the world. The entire frequency range is covered by means of plug-tuning units which are included. Each tuning has its own oscillator and power amplifier coils and condensers, and antenna tuning circuits — all designed to operate at top efficiency within its particular frequency range. Transmitter and accessories are finished in black crackle, and the milliammeter, volt-meter, and RF ammeter are mounted on the front panel. Here are the specifications: **FREQUENCY RANGE:** 200 to 500 KC and 1500 to 12,500 KC. (will operate on 10 and 20 meter band with slight modification for which diagrams are furnished). **OSCILLATOR:** Self-excited, thermo compensated, and hand calibrated. **POWER AMPLIFIER:** Neutralized class "C" stage, using 211 tube and equipped with antenna coupling circuit which matches practically any length antenna. **MODULATOR:** Class "B" — uses two 211 tubes. **POWER SUPPLY:** Supplied complete with dynamotor which furnishes 1000V at 350 MA. from either 12 or 24 volts. Complete instructions are furnished to operate set from 110V AC. **SIZE** 21 1/2 x 23 x 9 1/2". Total shipping wgt. 300 lbs., complete with all tubes, dynamotor power supply, seven tuning units, antenna tuning unit and the essential plugs.

SCR-274N COMMAND SET

The greatest radio equipment value in history
 A mountain of valuable equipment that includes 3 receivers that use plug-in coils, and consequently can be changed to any frequencies desired without conversion. Also included are two Tuning Control Boxes; 1 Antenna Coupling Box; four 28V Dynamotors (easily converted to 110V. operation); two 40-Watt Transmitters including crystals, and Pre-amplifier and Modulator. 29 tubes supplied in all. Only a limited quantity available, so get your order in fast. Removed from unused aircraft and in guaranteed electrical condition. A super value at **\$34.95**, including crank type tuning knobs for receivers.

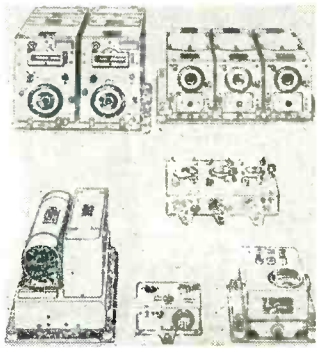

RT-1655—11 tube crystal controlled superheterodyne receiver that covers the FM band. The ultra modern circuit uses the latest types of tubes including 7 miniature 6AJ5's. Beautiful chassis and aluminum cabinet. Tubes and schematic supplied.—\$14.95

World renowned 700 page tenth edition of the **Radio Handbook** in cloth binding and hard cover at the sensational reduced price, for a limited time only, \$1.49

\$5.95 Takes Both BIG BARGAINS

1. **ALUMINUM GEAR BOX** 18x8x7 that contains two powerful electric motors and two matched gear trains, 22 gears in all varying in size from 1/2 to 4 inches in diameter. This unit is readily converted to rotate a beam antenna or any other similar use. \$3.00
 2. **SENSATIONAL FASCINATING, AMAZING SELSYNS.** Brand new selsyns made by G. E. Co. Two or more connected together work perfectly on 110 VAC. Any rotation of the shaft of one selsyn and all others connected to it will rotate exactly as many degrees in the same direction, following unerringly as if the units were connected together by shafting instead of wires. This is true whether you twist the shaft of the master unit a fraction of a revolution or many revolutions. Useful for indicating the direction of weather vanes, rotating directional antennas, or controlling innumerable operations from a distance. Complete with diagram and instructions. Per matched pair \$4.95



RT 1463 7 tube amplifiers containing 3-7F7, 1-7Y4, 3-7N7, 4 potentiometers, numerous resistors, filter and bypass condensers, filter chokes, power and audio transformers, and six sensitive plate relays. A military development that provided amazing stepless control proportional to correction required for ailerons, rudder and elevator. In the original application, a control amplifier of the ordinary type would deflect the rudder by some arbitrary amount when the ship was blown off the course to port or starboard. The result would either be that the correction was insufficient and the plane continued off course, or the correction would be too great, starting a series of tackings and would greatly increase fuel consumption and elapsed time in reaching the objective. This phenomenal unit, with its 3 amplifiers and six 6000 ohm, relays in bridge circuits, will accurately control any 3 operations, related or unrelated, in minutely adjustable uniquely quantitative variations in either forward or reverse directions, 9"x7"x8" black crackle aluminum case. Brand new in original carton, \$12.95, or used \$9.95.

VACUUM TUBE VOLT-OHM-CAPACITY METER

There are more features engineered into this all purpose instrument than in any other instrument on the market regardless of price. It was designed not only to meet present conditions but to be readily adaptable to future needs. At the sensationally low price of this precision instrument no school, plant, lab or service shop need deprive itself of the "new look" in measuring equipment. Here are a few of the many features of this outstanding meter:

- 5 inch easy to read meter.
- DC voltage ranges from 0 to 1000 V (Input resistance as high as 1 megohm per volt.)
- 5 AC voltage ranges from 0 to 1000 V (No dry disc rectifier to age and destroy the accuracy of this VACUUM TUBE VOLT-METER).
- 6 Resistance ranges from 2/10 ohm to 1000 megohms.
- 4 Capacity ranges from .00025 to 20 MFD.
- A zero center range for balancing FM discriminators.
- Isolating resistor built into probe.
- Sturdy natural finish hard wood case.

This outstanding development of one of the leading manufacturers of test equipment costs only \$39.95 complete with all leads, as illustrated.



RT-1579 consists of a three stage, cascade 6B17's and 6FG output stage high gain, high fidelity amplifier with 60 cycle, 110V power supply on the same 13 1/2 x 14 1/2 chassis, which is protected by a substantial steel cover over tubes and parts. Made by Western Electric with typical quality components such as a husky power transformer and oil condensers, this unit is obviously intended to give years of trouble-free service with no more need for repairs than a telephone. Disconnecting one wire each, from the special input and output filters, will result in as high a fidelity amplifier as can be obtained. Your cost with tubes, diagram and parts list included—\$14.95.

RT1711 Brand New 12 tube 110 Volt Receiver-Indicator-Oscilloscope complete with all tubes and power supply. Has hood over scope tubes, which is equipped with a detachable calibrated screen. Has centering and amplitude controls and two video inputs. A natural for television **\$39.95**

Cable Address: **BUFRAD** FOB **BUFFALO** UNLESS NOTED Minimum order **\$3.00**—All prices subject to change—25% deposit with COD orders.

BUFFALO RADIO SUPPLY, 219-221 Genesee St., Dept. 9-E BUFFALO 3, N. Y.

LARGEST STOCK OF TUBES IN THE COUNTRY

ALL BRAND NEW—STANDARD BRAND MINIMUM ORDER \$5.00
QUANTITY PRICES ON REQUEST

Type	Price	Type	Price	Type	Price	Type	Price	Type	Price	Type	Price	Type	Price
1B23	\$49.50	215A	3.00	860	3.00	RC4	105.00	2A4G	1.28	687	1.28	LSL7GT	.88
1B24	4.95	217C	7.50	861	49.95	KU676	22.00	687GT	.88	687GT	1.28	LSN7GT	.80
1B27	4.95	218	4.95	864	.69	ML100	105.00	2A6	1.06	688GT	1.06	12S07	.60
1B56	8.00	221A	2.95	865	2.98	ML101	150.00	2A7	1.06	68A7	.66	12S07GT	.60
1N21	.59	222A	120.00	866	1.95	ML502	300.00	2E5	.88	68A7GT	.66	12SR7	.39
1N23	.59	227A	3.95	866A	.88	MR4	90.00	2V3G	1.98	68C7	.72	12SR7GT	.39
1P22	11.50	241B	90.00	868	1.95	OK59	39.50	2X2A	1.25	68D7GT	.49	12X3	.98
1P24	2.00	242C	5.95	869B	75.00	OK60	39.50	3A4	.39	68F5	.66	12Q5	.72
1S21	1.95	249C	3.49	872A	2.95	OK61	39.50	3A5	1.39	68F5GT	.72	14A7/12B7	.88
2AP1	3.95	250R	7.95	874	2.49	OK62	39.50	3A8GT	1.98	68F7	.80	14AF7/XXD	.88
2B22	5.35	250TH	19.50	876	.98	REL21	4.25	3B7	.36	68G7	.80	14B6	.88
2C22	.39	250TL	19.50	878	2.49	RK12	1.95	3D6	.36	68H7	.39	14B8	.88
2C26A	.75	252A	4.95	879	.98	RK21	3.95	3Q4	.88	68J7	.66	14C5	.88
2C34	.59	259A	4.95	885	1.49	RK22	4.95	3Q5GT	.96	68J7GT	.66	14C7	.88
2C40	1.98	274A	1.25	885	.98	RK25	2.95	3S4	.80	68K7	.66	14E6	.72
2C43	7.50	274B	1.25	902P1	7.95	UK33	.98	3V4	.80	68L7GT	.66	14E7	.88
2C44	1.75	282A	9.95	905	11.95	RK34	.59	5A24	.50	68L7GT	.96	14F7	.88
2C46	7.50	301A	4.95	920	2.95	RK59	3.95	5R4GY	1.15	68N7GT	.88	14F8	1.06
2D21	1.69	304TH	6.95	923	.98	RK65	24.95	5T4	1.28	68O7	.60	14H7	.88
2E22	1.50	304TL	1.49	931A	.95	RK60	.79	5U4G	.60	68O7GT	.60	14J7	1.06
2E24	4.95	305A	12.95	950	1.06	RK69	49.50	5V4G	.96	68R7	.72	14N7	1.06
2E25	4.25	307A	4.95	954	.75	RK72	1.95	5W4	1.06	68R7GT	.72	14O7	.88
2E26	3.95	310	4.95	955	.75	RK73	.98	5X4	.66	68S7GT	.66	14O7GT	.88
2E30	2.49	311A	1.98	956	.75	RK75	6.25	5X4GT	.72	68V7	.88	14S7	1.06
2I21A	14.95	316A	.69	957	.75	RX120	10.00	5Y3GT	.42	6U5/6G5	.72	14W7	1.06
2J26	14.95	322A	120.00	958	.75	TZ40	2.95	5Y4G	.60	6U7G	.72	14X7	1.66
2J31	24.95	327A	4.95	958A	.75	UX6653	3.95	5Z3	.72	6V6	1.28	14X4	.88
2J32	24.95	331A	4.95	959	.75	V70D	6.95	5Z4	1.06	6V6GT	.80	14Y4	.88
2J33	24.95	338A	4.95	1000 SPEC.	24.95	VR75	.98	6A3	1.28	6V6GT	.80	15T8	1.06
2J34	24.95	350/A/B	2.95	1000T	75.00	VR78	.75	6A7	.80	6X5GT	.60	15T8	1.06
2J37	24.95	368AS	4.95	1608	4.95	VR90	.75	6A8	.80	6Y6G	.96	24A	.88
2J38	37.50	371A	2.95	1613	.89	VR92	.75	6A8GT	.80	6ZY5G	.88	25A7GT	1.16
2JB51	4.95	371B	2.95	1614	1.75	VR105	.75	6AB7 1853	1.06	7A4/XXL	.72	25AC5GT	1.16
2J54	25.00	388A	7.95	1616	1.39	VR150	.98	6AC5GT	1.16	7A5	.72	25L6GT	1.16
2K25	24.95	393A	7.95	1619	.75	VL127A	3.00	6AC7 1852	1.16	7B4	.72	25Y5	.66
3AP1	4.95	394A	24.95	1621	1.98	VL460	14.95	6ADG	1.06	7A8	.72	25Z5	.60
3B22	4.95	417A	24.95	1622	1.75	WL468	14.95	6AG5	1.06	7AD7	1.06	25Z6GT	.60
3B23	4.95	434A	3.95	1624	1.75	WL532A	4.95	6AG7	1.28	7AF7	.72	26	.72
3B24	1.95	446A	1.95	1625	.49	WL562	150.00	6AH6	3.90	7AG7	.88	27	.72
3B25	1.25	450TH	24.95	1626	.49	WL616	105.00	6A15	.99	7AF7	.88	28D7	.39
3B26	5.95	503	195.00	1627	7.95	WL619	49.50	6AK5	1.56	7AF7	.88	30	.39
3BP1	3.95	527	12.95	1628	4.95	Z25	8.00	6AK6	.96	7B4	.88	31	.39
3C21	5.95	531A	24.50	1629	.69	0A2	1.69	6AL5	.80	7B5	.72	32	1.28
3C22	12.95	575A	14.95	1630	7.50	0A3/VR75	.98	6AL7GT	1.06	7B6	.72	32L7GT	1.28
3C23	4.95	632A	9.95	1636	5.95	0A4G	1.06	6AO5	.80	7B7	.72	33	.39
3C24	1.69	701A	4.95	1638	.98	0B2	2.05	6AO6	.72	7B8	.72	34	.39
3C30	1.50	702A	3.95	1641	.79	0B3 VR90	.75	6AO7GT	.88	7C4 1203A	.39	35 51	.80
3CP1	3.00	703A	4.95	1642	.98	0C3 VR105	.75	6AR5	.66	7C5	.72	35A5	.72
3BP1	3.95	704A	1.98	1644	1.49	0D3/VR150	.75	6AS5	.66	7C6	.72	35B5	.80
3EP1	3.95	705A	24.95	1654	1.98	0Y4	.88	6AT6	.60	7C7	.72	35L6GT	.66
3FP7	7.06BY	24.95	1665	1.25	0Z4	.88	6AV6	.80	7E5 1201	1.06	35W4	.46	
4-65A	14.50	706CY	24.95	1851	1.06	0Z4G	.88	6AV6	.60	7E6	.72	35Y4	.72
4-125A	27.50	707A/B	24.95	1852	1.06	01A	.50	6B4G	1.28	7E7	.88	35Z3	.72
4-250A	37.50	708A	7.95	1853	1.06	1A3	.72	6B5	1.56	7F7	1.06	35Z4GT	.60
4A1	1.98	709A	9.95	1963	.95	1A4	1.28	6B6	.88	7B8	.88	35Z5GT	.50
4AP10	6.95	710A	2.95	2050	1.19	1A5	1.56	6B7	1.28	7C7/1232	1.06	36	.39
4B24	4.95	712A	1.65	2051	1.98	1A6	1.28	6B8	1.28	7H7	1.06	37	.39
4C35	19.95	714AY	14.95	2051	20.00	1A7GT	.72	6B8G	1.28	7I7	1.06	38	.39
4J26	110.00	715A/B	9.95	2140	4.95	1A8	1.28	6BA6	.72	7K7	1.06	39/44	.39
4J33	49.50	715C	24.95	5514	5.95	1A7GT	.80	6BE6	.72	7L7	.88	41	.66
5AP1	4.95	717A	.99	5562	10.00	1B3GT	1.49	6BG6G	1.92	7N7	.88	42	.66
5AP4	5.95	720CY	34.95	7193	.39	1B4	1.56	6BH6	.80	7O7	.88	45	.66
5BP1	2.95	721A/B	4.95	8003	5.95	1B5 2S	1.28	6B16	.80	7P7	.88	45Z5GT	.72
5BP4	4.95	723A/B	4.95	8005	4.95	1C3GT	.88	6C5	.39	7S7	1.06	50	.66
5CP1	3.95	724A/B	4.95	8008	3.75	1C6	1.28	6C5	.66	7V7	1.06	50A5	1.06
5CP7	13.95	725A	24.95	8011	2.95	1C7G	1.28	6C5GT	.66	7W7	1.06	50B5	.66
5D21	29.95	726A	23.50	8012	4.95	1D5G	1.56	6C6	.80	7X7/XXFM	1.06	50C5GT	.66
5FP7	3.95	750TL	49.50	8013	2.95	1D5GP	1.56	6C8G	1.28	7Y4	.72	50E6GT	.66
5GP1	9.95	800	2.25	8016	1.49	1D7G	1.28	6D6	.66	7Z4	.72	50F6GT	.66
5LP1	11.95	801A	3.98	8020	3.95	1D8GT	1.56	6D8G	1.28	8A6	.69	50G6GT	.66
6AF6G	88	802	2.95	8027	7.95	1E7G	1.56	6E5	.85	12A	.60	50Y6GT	.72
6C21	24.95	803	8.95	8031	12.95	1F4	1.06	6F5	.66	12A6	.39	53	1.06
6J4	3.95	804	12.95	C6A	9.95	1F5G	1.06	6F5GT	.66	12A6GT	.39	56	.72
6Q5G	1.25	805	5.95	C6J	12.95	1F6	1.56	6F6	.80	12A7	1.28	57	.80
7BP7	4.95	806	17.50	CE072	1.95	1F7G	1.56	6F6GT	.66	12A8GT	.88	70L7GT	1.56
7EP4	17.40	807	1.25	CK1005	.39	1G4GT	1.06	6F7	1.06	12A7GT	.80	71A	.80
7FP4	19.40	808	2.95	CK1006	.69	1G6GT	1.06	6F8	1.28	12A5	.60	75	.66
9GP7	15.00	809	2.95	CK1090	4.95	1H4G	.88	6G6G	1.06	12A6	.60	76	.66
9LP7	4.95	810	7.95	EF50	.79	1H5GT	.66	6H6	.60	12A7	1.06	77	.66
9MP7	14.95	811	2.45	EL3C	4.95	1H6G	1.28	6H6GT	.60	12A7	.60	78	.66
10BP4	34.95	812	2.95	EL225	1.95	1H6GT	1.28	6J5	.54	12A8	.72	79	.88
10HP4	49.50	812H	6.90	F123A	12.95	1H6GT	1.56	6J5GT	1.28	12A9	.72	80	.88
10Y	.69	813	8.95	F127A	23.50	1I4	.80	6J6	1.16	12RE6	.72	80	.46
10 SPEC	.69	814	3.95	F660	150.00	1I4A	1.06	6J7	.80	12R8	.72	81	1.56
12DP7	14.95	815	2.95	FG17	3.25	1IA6	1.06	6J7GT	.80	12F5GT	.72	82	1.06
12GP7	14.95	816	1.19	FG27A	9.95	1IB4	1.06	6J8G	1.28	12H6	.39	83V	1.28
12JP4	60.00	822	11.95	FG81A	6.95	1IC5	1.06	6K5GT	.96	12J5GT	.80	84 GZ4	.72
15AP4	125.00	826	.69	FG105	19.95	1IC6	1.06	6K6GT	.60	12J7G	.80	85	.88
15E	1.50	827R	99.50	FG172A	32.50	1ID5	1.06	6K7	.66	12J7GT	.80	85	.88
15R	1.50	828	6.95	FG238B	160.00	1IE3	1.06	6K7GT	.66	12K7GT	.66	89	.72
20AP4	270.00	829A/B	7.95	GL146	11.00	1IF5	1.06	6K8	.96	12K8	.88	89Y	.39
23D4	.49	829B/3E29	4.95	GL207	110.00	1IH4	1.06	6K8GT	.96	12K8GT	.96	117L7GT	1.56
45 SPEC	.49	830	2.95	GL559	5.35	1IN5	1.06	1L5G	1.06	12Q7GT	.72	117M7GT	1.56
75TL	3.95	830B	5.25	GL605	250.00	1NSGT	.80	6L6	1.42	12SA7	.66	117N7GT	1.56
100TH	12.95	832A	4.95	GL697	150.00	1P5GT	1.06	6L6G	1.16	12SA7GT	.66	117P7GT	1.56
100TS	3.00	833A	34.50	HF100	17.95	1Q5GT	1.06	6L6GA	1.16	12SC7	.72	112Z3	.60
102F	4.00	836	1.15	HY24	1.50	1R4	1.06	6L7	.80	12SF5	.80	117Z4GT	1.16

SURPLUS MATERIAL—Shipped Immediately

Thousands of Relays Available—Send for Complete Listings

TUBES! GUARANTEED!

TYPE	PRICE	TYPE	PRICE
1LA6	\$1.65	851	\$49.50
1L4	.65	860	2.75
1V	.65	864	.65
2X2/879	.65	866A	.75
3A4	.45	872A	1.65
5R4GY	.95	954	.45
6AC7	.95	957	.45
6AG7	.95	968	.25
6C4	.29	1613	.85
6F8	.95	1616	.95
6G6G	.85	1625	.45
6H6GT	.55	1626	.45
6L6	1.10	1629	.18
6SA7	.65	1632	.18
6SD7	.45	1641/RK60	.65
6SQ7	.65	1644	1.25
6SJ7	.65	1294/1R4	.65
6Y6	.75	3D6/1299	.65
6X5	.65	388A	3.95
7B7	.65	394A	2.95
7C7	.95	9002	.35
7F8	.95	9003	.25
7N7	.85	9006	.35
7Y4	.75	8013	2.95
12K8	.95	RK60/1641	.65
12Q7	.55	RK72	.75
12SL7	.65	RK73	.45
12SN7	.65	1B24	1.95
30 SPECIAL (VT67)	.45	2C46	3.95
32	.65	3B27/836A	.95
25Y5	.85	3C23	2.95
25Z6	.75	4B27	2.95
35L6	.65	4C33	2.95
38	.65	4D32	9.50
45 SPECIAL (VT52)	.35	14E6	.55
56	.55	23D4	.45
89	.15	HY114B	.45
210	.65	5CP1	3.95
250	.65	2J1005	.35
350B	4.95	Amperite Voltage Regulator 13-4	.25
801	.95	Hytron Ballast 100-79	.25
814	4.95	E1148	.95
826/2J	.95	VR78	.45
841	.65		
843	.65		

WIRE! WIRE!

At Giveaway Prices

Thousands and thousands of feet available of various types, sizes, and colors.

VINELITE, AEROGLAS COTTON BRAIDED

Size	Price
22	\$3.75/M
20	4.25/M
18	4.75/M
16	5.75/M
12	6.75/M
10	7.75/M

SHIELDED

Size	Price
18	\$20.00/M
20	15.00/M
22	12.00/M

ROCKBESTOS

Size	Price
7/.020TC	\$6.75/M
Spec #NSH3S	
10/.0105 TC	4.75/M
Spec #NSH1S	

PLASTIC

Size	Price
27	\$2.25/M
28	2.25/M

BARE SOLID TINNED

Size	Price
12	\$.50 lb.
14	.65 lb.
22	.85 lb.
24	.85 lb.

4000-6000 VOLT LOW CURRENT DC SUPPLY

Brand new completely wired and tested. Ready to operate from 115 volt power line. D.C. output is filtered. Price Complete \$12.50
 2000-3000 Volt D.C. Supply similar to above, but with lower output voltage. Ready to operate from 115 Volt power line. Price Complete \$7.95

HIGH FIDELITY INPUT TRANSFORMERS

Ferranti #4794 Balanced winding, shielded type. Description—Turns ratio step-up 2/1 primary inductance 133 Henrys ± 1 DB 60-9000 cycles. Can be used to match any single or push-pull plates to any single or push-pull grids—overall dimensions 2 1/4" x 3" x 2 1/2" Price \$1.75

STANDARD BRAND PRECISION RESISTORS

Following sizes are in 1% and 2% tolerance Price \$.35

1 meg	66,000	1500
.8 "	54,500	1400
.75 "	46,000	1200
.7 "	40,000	1000
.6 "	33,000	750
.268 "	13,300	235
.22 "	12,000	130
125,000	10,000	125
120,000	7,500	110
109,000	4,500	55
100,000	4,300	22
95,000	4,000	20
92,000	2,500	14
84,000	2,230	12
82,000	2,200	10
80,000	1,700	6

Following sizes are 5% or better tolerance, Price \$.15

110,000	70	40
22,000	50	35
15,000		30
2,500		

Following sizes are 1% or better Price \$.10

4,285	53.32	4.35
1,123	33.22	4.3
988	23.29	3.94
366.6	13.52	3.5
220.4	13.333	1.563
147.5	10.2	.29
105.8	5.1	.268
53.96	4.4	.25

COAXIAL CABLE

TYPE	IMPEDANCE	PRICE
RG 6/U	76 Ohms	.041 1/2 ft.
RG 38/U	55 Ohms	.041 1/2 ft.
RG 62/U	93 Ohms	.073 1/2 ft.
RG 77/U	48 Ohms	.041 1/2 ft.

MALLORY RADIO NOISE FILTERS

Model NFRD

Eliminates extremely noisy radio reception due to power line disturbances caused by lights, refrigerators, washing machines, vacuum cleaners, elevators, oil burners, diathermy machines, etc. Filters out man-made noises in the broadcast short-wave and ultra-high frequency bands.

Designed for radios, appliances, and electrical equipment consuming up to 1300 watts (12 amperes) at 120 volts AC or DC.

Housed in a metal case 1 1/2" x 3" x 7 1/2" complete with male and female line connectors. Price Only \$1.95

Mallory NF 12-6EG—Housed in a bathtub type container and rated at 7 amps, 50 volts D.C. Solder lug terminals. Price \$.35

Mallory NF7-3A—Housed in silver-plated rectangular case 3 1/4" x 1 1/2" x 2 1/2" with male and female amphenol AN3108 plugs. Price \$.95

Mallory NF7-4—Housed in rectangular case 3" x 1 1/2" x 7 1/2". Internal screw terminals. Rated at 12 amperes—35 V. D.C. Price \$.95

Bendix—model 3937—Generator Filter—50 amps, 120 Volts D.C.—Housed in shielded containers 4" x 3 3/4" x 8" Price \$1.25

Line Noise Filter—Unshielded and mounted on a bracket. Suitable for use on regular power lines—Consists of two .01 molded condensers and 140 turn solenoid choke coil Price only \$.10

TRANSTAT VOLTAGE REGULATORS

Model #29144

Fixed Winding 115 Volts—60 cycles Commutator range 75-120 Volts Maximum output .25 KVA Housed in shielded case 5" x 6" x 6" Price \$6.95

Type RH

Fixed Winding 115 Volts—400 cycles Commutator ranges 75-120 Volts Load—72 KVA Housed in Shielded case 5 1/2" x 6" x 6 1/2" Price \$1.95

Write for Latest Catalog

EDLIE ELECTRONICS, INC.

154 GREENWICH STREET

TELEPHONE DIgby 9-3143

NEW YORK 6, N. Y.

IMMEDIATE DELIVERY



DYNAMOTORS

D-101. 27 v. DC in @ 1.5 amps. DC output 285 v. @ 0.60 amps. Stock #SA-187. Price \$1.50 each. **DM-40A.** 14 v. DC in @ 3.4 amps. DC output 172 v. @ .138 amps. Stock #SA-188. Price \$3.25 each.

MICROWAVE ANTENNA—

AS-217A/APG 15B. 12 Cm dipole and 13 inch Parabola housed in weatherproof Radome 16" diam. 24 V. DC spinner motor for conic scan. Stock #SA-95. Shipping wt. 70 lbs.

Price \$9.50 ea.



Remote Position Indicating System



6-12 V. 60 cycles 5 inch indicator with 0 to 360° dial. Heavy duty transmitter. Stock #SA-115.

Price \$9.95 per system

SPERRY PHASE ADAPTOR — 661102 115 volts 400 cy. Used for operating 3 phase equipment from single phase source. Stock #SA-194. Price \$6.75 each.

RATE GENERATORS



Elenco PM-2 Approx. 2.0 v. DC per 100 rpm. Use to 2000 rpm. Stock #SA-53. Price \$7.50 ea.

ELINCO E-16. 2 Phase AC. 1.3 v AC per 100 rpm. 60 cy. output at 1800 rpm. Stock #SA-193. Price \$12.50 each.

400 CYCLE WESTINGHOUSE FL BLOWER



115 v. 400 cy. 17 c.f.m. Includes capacitor. Stock #SA-144. Price \$6.75 each.

SWEEP GENERATOR CAPACITOR



Hi-speed bearings. Split stator. Silver plated coaxial type. 5-10 mmf.

Stock #SA-167. Price \$2.75 each.

TXW Pat-199.

Write for complete listing, or call ARmory 4-3366

INVERTERS

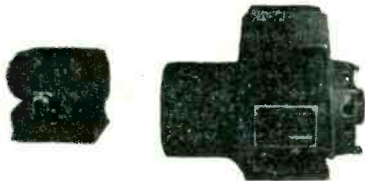

400 Cycle Three Phase

Holtzer-Cabot MG-153F— Input 28 volts DC at 52 amps. Output three phase 115 volts 400 cycles at 750 V.A. 0.90 P.F. Also second output of 26 volts 400 cycles at 250 V.A. voltage and frequency regulated. Stock #SA-135.

Pioneer 12123-1A— Input 28 v. DC at 12 amps. Output three phase 115 volts 400 cycles at 100 V.A. Voltage and frequency regulated. Stock #SA-5.

Leland SD-93— Input 28 volts DC at 60 amps. Output 115 volts 3 phase 400 cycles at 750 V.A. 0.90 P.F. Second output of 26 volts 400 cycles at 50 V.A. 0.40 P.F. Voltage and frequency regulated. Designed for use with various autopilots. Stock #SA-209.

400 Cycle Single Phase

Wincharger PU7/AP— Input 28 v. DC at 160 amperes. Output 115 volts 400 cycles at 2500 V.A. Voltage and frequency regulated. Cont. duty. Wt. 75 lbs. Stock #SA-164.

Pioneer 12117-2— Input 28 v. DC at 1 amp. Output 26 volts 400 cycles at 6 V.A. Cont. duty. Stock #SA-49.

Pioneer 12117-5— Input 14 v. DC at 2 amps. Output 26 volts 400 cycles at 6 V.A. Cont. duty. Stock #SA-96.

Holtzer Cabot MG-149F— Input 28 v. DC at 36 amps. Output 115 volts 400 cycles at 500 V.A. P.F. 0.40. Second output of 26 volts 400 cycles at 250 V.A. Stock #SA-86.

Holtzer Cabot MG-149H— Similar to MG-149F but draws 44 amps DC at 28 v. Output ratings are at 0.90 P.F. Equipped with high altitude brushes. Stock #SA-4.

General Electric 5D21N3A— Input 28 volts DC at 35 amps. Output 110 volts 400 cycles. 485 V.A. at 0.90 P.F. Weight 15 lbs. Stock #SA-41.

General Electric 5AS131JJ11A (PE-218)— Input 28 volts DC. 92 amps. Output 115 volts 400 cycles at 1500 V.A. 0.90 P.F. Stock #SA-112.

800 Cycle Single Phase

Navy Type CRV-21AAR. G.E. 5AS121LJ2— Input 27 v. DC at 45 amps. 120 volts 800 cycle out at 750 V.A. 0.90 P.F. Wt. 23 lbs. Stock #SA-192.

NOTE

All merchandise is new and guaranteed to meet original manufacturer's specifications. Delivery from stock.

Servo Motor

Pioneer Type CK-2. 2 phase 400 cycle. Fixed phase 26 V., var. phase. 49 V. max. 1.05 oz/in. stall torque. Stock #SA-97. Price \$4.75 ea. net



Blower Assembly MX-215/APG



John Oster C-2P-1L 28 V. DC. 7000 RPM 1/100 H.P. #2 L-R Blower.

Stock #SA-202. Price \$3.75 each

G.E. 10 rpm DC Motor 5BA 10FJ12



Output 40 lb. in at 10 rpm. 24 V. @ 1.1 amps. Series-wound #2 wire reversible.

(Housing is Common Lead)

Ideal for relay servo-systems. Stock #SA-17. Price \$8.75 each.

Phase Shift Capacitor— 4 stator single rotor 0-360° phase shift. (Use in complex wave synthesis.) Stock #SA-114. Price \$4.75 ea.

Delco PM Motor—5068571



Alnico field. 27 v. DC. 10,000 rpm. 1" x 1" x 2" shaft 21/32 Lg. x 0.125 diam. Stock #SA-151. Price \$3.75 each.

12V DC MOTOR John Oster B-9-2



1.4 amps. 5600 rpm.

1 1/4" Diam. x 3 3/4" Lg. Spline shaft CW rotation. Stock #SA-46. Price \$3.75 each

Delco PM Motor 5069600. 27 V. DC—250 RPM. Spline Shaft. Prices on Request.

LP-21-LM Compass Loops



New

Original Cartons Stock #SA-99. Price \$9.50 each.

110 RPM MOTOR

G.E. 5BA10J18D, 27 V. @ 0.7 amps. 1 oz/ft. torque. 1 3/4" diam. x 3 1/4" lg. Operates on AC or DC. Stock #SA-98.



Include 15¢ for P.P. and handling Price \$2.95 ea. net

4 Godwin Ave.

SERVO-TEK
PRODUCTS CO.
Incorporated
Surplus Division

Open account shipments to rated concerns. All prices F.O.B. Paterson, N. J.

Paterson, N. J.

MYCALEX SOCKET
for 813, 4E27/257B
TYPE TUBES

59¢ ea.

RHS
SPECIALS OF THE MONTH

FREE!

Send for our new, fully
illustrated catalog —
just off the press!

1 K.W. POWER SUPPLY KIT
2500-0-2500 Volts @ 500 MA

2000-0-200 Volts @ 500 MA

(oil-filled Xformer from BC610) **\$39.95**

- 1—Swinging choke **14.95**
- 1—Smoothing choke **7.95**
- 1—Filament Xformer **9.95**
- 2—2 Mfd., 3000 v. Condensers, ea **3.45**
- 2—872A Tubes each **1.95**
- 2—Plate Caps for 872A each **.20**
- 2—Sockets for 872A each **1.19**
- 2—Hash Filter Chokes **.79**

All parts New! Reduced to **\$79.50**

SELENIUM RECTIFIERS
Full Wave Bridge Type

INPUT	OUTPUT	
up to 18v AC	up to 12v DC	1/2 Amp. \$0.98
up to 18v AC	up to 12v DC	1 Amp. 1.95
up to 18v AC	up to 12v DC	3 Amp. 3.45
up to 18v AC	up to 12v DC	5 Amp. 4.45
up to 18v AC	up to 12v DC	10 Amp. 7.45
up to 18v AC	up to 12v DC	15 Amp. 9.95
up to 18v AC	up to 12v DC	30 Amp. 14.95
up to 36v AC	up to 28v DC	1 Amp. 3.45
up to 36v AC	up to 28v DC	5 Amp. 7.45
up to 36v AC	up to 28v DC	10 Amp. 12.45
up to 36v AC	up to 28v DC	15 Amp. 18.95
up to 115v AC	up to 100v DC	.25 Amp. 2.95
up to 115v AC	up to 100v DC	.6 Amp. 6.95
up to 115v AC	up to 100v DC	5 Amp. 19.95
up to 115v AC	up to 100v DC	3 Amp. 12.95

OIL CONDENSERS
NATIONALLY ADVERTISED BRANDS

All Ratings D. C.

Value	Price	Value	Price
2x.1mfd. 600v	\$0.35	1mfd. 2000v	\$0.95
.25mfd. 600v	.35	2mfd. 2000v	1.75
.5mfd. 600v	.35	4mfd. 2000v	3.75
1mfd. 600v	.35	15mfd. 2000v	4.95
2mfd. 600v	.35	4mfd. 2500v	3.98
4mfd. 600v	.60	2mfd. 2500v	2.49
8mfd. 600v	1.10	1mfd. 2500v	1.25
10mfd. 600v	1.15	.25mfd. 2500v	1.45
3x.1mfd. 1000v	.45	.5mfd. 2500v	1.75
.25mfd. 1000v	.45	.05mfd. 3000v	1.95
1mfd. 1000v	.60	1mfd. 3000v	2.25
2mfd. 1000v	.70	.25mfd. 3000v	2.65
4mfd. 1000v	.90	1mfd. 3000v	3.50
8mfd. 1000v	1.95	12mfd. 3000v	6.95
10mfd. 1000v	2.10	2mfd. 4000v	5.95
15mfd. 1000v	2.25	1mfd. 5000v	4.95
20mfd. 1000v	2.95	1mfd. 7000v	2.95
24mfd. 1500v	6.95	3mfd. 4000v	6.95
1mfd. 1750v	.89	2mfd. 3000v	3.45
1mfd. 2000v	.95	2x.1mfd. 7000v	3.25
.25mfd. 2000v	1.05	.02mfd. 12000v	9.95
.5mfd. 2000v	1.15	.02mfd. 20000v	11.95

HIGH CAPACITY CONDENSERS

10,000 mfd.—25 WVDC	\$6.95
2x3500 mfd.—25 WVDC	3.45
2500 mfd.—3 VDC	.39
3000 mfd.—25 WV DC	2.49
2x1250 mfd.—10 VDC	1.25
1000 mfd.—15 WVDC	.99
200 mfd.—35 VDC	.59
100 mfd.—50 WVDC	.49
4x10 mfd.—400 VDC	.89
4000 mfd.—18 WVDC	1.95
4000 mfd.—25 WVDC	2.95
4000 mfd.—30 WVDC	3.25

FILTER CHOKES

HI-VOLTAGE INSULATION

8 hy @ 550 ma.	\$7.95	325 hy @ 3 ma.	\$3.45
8 hy @ 300 ma.	3.95	1 hy @ 800 ma.	14.99
25 hy @ 160 ma.	3.49	10 hy @ 250 ma.	2.45
12 hy @ 150 ma.	2.25	10 hy @ 200 ma.	1.98
30 hy @ 70 ma.	1.39	10/20 @ 85 ma.	1.59
.05 hy @ 15 amps.	7.95	15 hy @ 125 ma.	1.49
.1 hy @ 5 amps.	6.95	15 hy @ 100 ma.	1.39
4 hy @ 800 ma.	5.95	3 hy @ 50 ma.	.29
200 hy @ 10 ma.	3.49	30/30 Dual @ 20 ma.	1.49
600 hy @ 3 ma.	3.49	8/30 hy @ 250 ma.	3.50
.065 hy @ 2.5A	2.49	10 hy @ 100 ma.	1.29

RADIO TUBES

NEW! STANDARD BRANDS!

1B24	\$1.95	726A	\$4.50	1Q5GT	\$9.95
1B26	4.95	800	1.75	1R5	.79
1B29	.89	801A	.75	1R4	.69
1N21	.59	802	2.95	1R5	.65
1N23	.59	803	5.95	1T4	.59
1N34	1.60	805	4.49	3Q4	.69
1P24	.89	807	1.25	3Q5	.69
2A21	2.39	808	1.95	3S4	.59
2C22	2.19	809	1.50	5Y4GT	.55
2C26	.29	810	5.95	6A7	.59
2C40	.74	811	1.49	6A8GT	.59
2C44	1.29	812	1.98	6AG5	.98
2C46	3.75	813	5.25	6AG7	1.19
2D21	1.59	814	2.75	6B4G	.98
2J21	12.95	815	1.45	6B6G	1.98
2J22	12.95	816	1.10	6C6	.49
2J26	9.95	828	.85	6D8	.49
2J31	24.95	829B	4.85	6F5GT	.49
2J32	14.75	832A	2.95	6F6GT	.49
2J36	24.95	833A	29.50	6F6	.81
2J37	24.95	836	.79	6H8GT	.49
2J38	14.75	837	1.49	6J5GT	.45
2J39	18.95	838	3.25	6J5	.59
2J40	24.95	841	.50	6J7GT	.55
2J46	18.95	843	.59	6K6GT	.49
2J49	26.95	845	3.29	6K7GT	.55
2J51	49.50	851	39.50	6L6G	.95
2J54B	18.95	860	1.98	6L6	1.23
2J55	18.95	861	11.95	6L7	.99
2K25	24.95	866	.85	6Q7GT	.55
2K28	8.95	866A	.85	6SA7GT	.49
2V30	.98	866JR	1.10	6SC7	.55
2X2	.59	869B	2.85	6SF5GT	.59
3A21	2.79	874	.69	6SH7	.49
3B21	1.39	876	.89	6S7GT	.49
3B22	.69	877	1.89	6S7GT	.49
3B24	.29	884	.49	6S7GT	.74
3B26	3.95	885	.98	6S7GT	.59
3CP1	2.95	902P1	7.95	6S7GT	.49
3C22	12.95	905	8.95	6V6GT	.69
3C23	2.95	923	.69	6X5GT	.65
3C24	.59	954	.35	7A6GT	.79
3C30	.69	955	.39	7B7GT	.79
3C31	1.49	956	.45	7C5	.79
3DP1	2.25	957	.35	7C6	.79
3D21A	1.50	958	.35	7F7	.49
3E29	3.39	1811	.99	7Y4	.35
4B24	3.95	1813	.58	12A4GT	.49
4E27	11.95	1816	.75	12A76	.49
5AP4	4.75	1819	.21	12A06	.75
5BP1	1.10	1822	1.75	12PA6	.49
5BP4	4.95	1824	.85	12BE6	.49
5CP1	2.95	1825	1.10	12J5GT	.49
5D21	5.95	1826	.75	12J7GT	.49
5FP7	.85	1829	.19	12K7GT	.49
5JP1	11.95	1830	3.95	12Q7GT	.74
5J29	18.95	1838	.69	12R87GT	.49
5J30	18.95	1854	1.98	12SF5GT	.49
5LP1	11.95	1851	.98	12SF7GT	.59
5R4GY	5.95	2050	.75	12S7GT	.49
5T4	.69	2051	4.85	12K7GT	.49
5U4G	4.45	8005	3.65	12S7GT	.49
5V4	.72	8011	.65	12SR7GT	.49
5X4	.59	8012	2.75	14A7	.69
5Y3	.39	8013	.89	14B6	.69
5Z3	.59	8014	1.65	14Q7	.69
5Z4	18.79	8016	1.85	14A	.49
6AB7	.95	8020	.89	25L6GT	.49
6AC7	.59	8025	4.95	25T5	.45
6AK5	.89	9001	.45	25Z6GT	.45
6AL5	.59	9002	.35	26	.45
6B4	1.25	9003	.35	27	.49
6D4	1.25	9004	.29	30 Sroc	.39
6J4	3.95	9005	4.45	32L7GT	1.19
6J6	.89	9006	.29	35V5	.59
6O5G	1.25	CK1005	.29	35A5	.72
7EP4	17.95	CK1006	.69	35L6GT	.49
10Y	.89	CK1090	1.49	35W4	.39
12A6	.25	FF50	.50	35Z4	.69
12DP7	13.95	F12A	12.95	35Z7	.79
12GP7	12.95	F12A7	17.50	35Z5GT	.39
15E	.89	F128A	69.50	36	.59
15R	.89	FF60	59.50	41	.75
75T	3.75	FG81A	4.75	42	.50
100TH	9.95	FG105	4.95	43	.54
211	3.35	FG238B	98.50	45	.55
227A	3.75	GL146	10.95	45 Spec	.35
231D	2.49	GL805	149.50	47	.74
249C	1.75	GL697	49.50	50A5	.89
250TH	19.49	HY75	1.25	50B5	.59
304TL	3.95	HY615	.75	50L8GT	.52
316A	.79	MI101	99.50	50V6GT	.75
327A	4.95	MI502	99.50	59	.95
350B	2.95	VR75	.98	70L7GT	1.29
388AS	6.95	VR90	.65	71A	.74
371B	.99	VR105	.65	75	.59
450TH	24.95	VR150	.65	76	.49
527	8.95	VT127A	3.49	77	.49
531	2.50	VU111	1.29	78	.49
559	.75	0Z4	.59	79	.85
703A	4.95	1A5GT	.54	80	.40
705A	1.85	1A7GT	.59	81	1.55
706CY	18.95	1H5GT	.59	82	1.15
714AY	7.95	1N5GT	.5	83	1.29
715B	9.95	1LA4	.95	83V	1.45
716C	18.95	1LA6	.95	84	.69
717A	.59	1LB4	.95	89	.69
721A	.59	1LC6	.95	117L7GT	1.15
723A/B	5.95	1LD5	.95	117P7GT	1.15
724A/B	1.75	1LH4	.95	117Z3	.89
725A	7.45	1LN5	.95	117Z6GT	.75

500 WATT POWER SUPPLY KIT

(Ideal for BC-191 & BC-375E)

- 1—Transformer—Pri: 105/250v
 - 60 cyc in 5v Steps
 - Sec: 1120-0-1120v @ 500 MA
 - 2 1/2v CT @ 10 AMPS
 - 12v @ 14 AMPS
 - 17v @ 2 1/2 AMPS
 - 32v @ .025 AMPS... **\$32.50**
 - 2—Filter Chokes @ \$7.95 ea. **15.90**
 - 2—Condensers 3 Mfd @ 2000v DC @ \$4.45 ea. **8.90**
 - 2—866 Tubes @ \$.89 ea. **1.78**
 - 2—Plate Caps Ceramic @ \$.20 ea. **.40**
 - 2—Sockets @ \$.20 ea. **.40**
 - 1 Pair Hash Filter Chokes **.79**
- Extra Special Buy \$49.50**

TRANSFORMER—115 V. 60 Cy.

HI-VOLTAGE INSULATION

3710v @ 10 ma.; 2x2 1/2v @ 3A	\$9.95
2500v @ 15 ma.	6.50
2500v @ 4 ma.; 2 1/2v @ 2A. 6.3v @ 1 amp.	7.95
2150v @ 15 ma.	5.50
175	



PARABOLOIDS

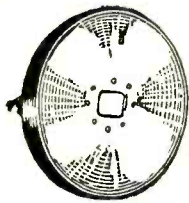

Ideal for microwave experimental work.
Spun Magnesium dishes
Reinforced Perimeter
17½" Diameter x 4" Deep
Two sets mounting brackets on rear
Open center hole 1½" x 1½"

Per Pair, Brand New... \$8.75

MERCURY CONTACT RELAY

Western Electric D-168479

For applications in all types of high speed switching devices. Long service life, high operating speeds. Large current and voltage handling capacity, uniform and constant operating characteristics under adverse atmospheric conditions. Hermetically-sealed mercury-wetted contacts in gas-filled glass envelope. Free from moisture, dirt, corrosion and atmospheric pressure. Single pole double throw contacts.
1000 hours life at 60 operations per second. Two coils of 700 ohms, and 3300 ohms. Operating current, coils series aiding—6.6 mils. Release current, coils series aiding—5.2 mils. Four page Technical Data on request.



Brand New in Original Cartons, \$4.75

STEPDOWN TRANSFORMERS

Input: 115V. 60 cycles.
Output: 20 V., at 10 amps.
Also tapped at 6V., for pilot light. Ideal for Selenium Rectifier Applications, etc.

Brand New \$2.45



PAN-OSCILLO-RECEIVER

Ideal for laboratory, television and general service work.

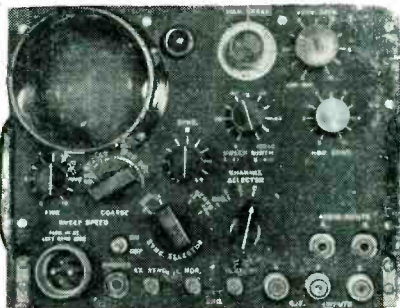

Model AN/APA 10

Performs work of four units

- PANORAMIC ADAPTOR:** For use with any receiver with I.F. frequency of 405-505 kcs., 4.75 to 5.75 mcs., and 29-31 mcs.
- OSCILLOSCOPE:** Visually checks received signals, monitors transmitter output, percentage modulation, carrier wave-shape, etc.
- SYNCHROSCOPE:** External inputs provide synchroscope action.
- RECEIVER:** Three inputs provide facilities for use with converters to cover wide range of frequencies to 10,000 mcs.

FEATURES:

- 3" scope tube
- 21 tubes
- Variable sweep 35-40,000 cy
- Transformer built in for 110 V. 60 cycle operation
- 2 I.F. stages—double conversion
- 2 Video stages in push pull to vertical plates
- Pentode output audio monitor
- Multi-Vibrator horizontal sweep (radar type)
- Horizontal sweep amplifiers P.P. to horizontal plates

Surplus equipment tested and guaranteed in perfect operating condition. We have sold hundreds of these units to leading schools, laboratories, amateur operators all over the world

\$149.50

(Mail \$3.50 for 80 page Technical manual and instruction book)

SHOCK MOUNTS



- | | | |
|--|-------|-----|
| A. Lord #20, 3" x 3" x 1 1/2" | | .40 |
| B. U. S. Rubber #5150 C 2 3/4" x 2 1/2" x 1 1/2" | | .30 |
| C. Lord #15 2 3/4" x 2 3/4" x 1 1/4" | | .25 |
| D. Lord #10 1 1/4" x 1 1/4" x 5/8" | | .10 |
| E. Lord #3 1 1/4" x 1 1/4" x 3/8" | | .10 |
- BRAND NEW

LINEAR SAWTOOTH POTENTIOMETER

W.E. No. KS 15138



The d-c potentiometer consists of a closed type die-cast aluminum alloy frame consisting of a continuous resistance winding to which electric power is supplied through two fixed taps 180 degrees apart. Two rotating brushes (180 degrees apart and bearing on the resistance winding) and two take-off brushes are provided for the output voltage. Varying the position of the brushes varies the output voltage in accordance with a linear sawtooth wave. The potentiometer is excited with 24-volt direct current, is arranged for panel or bracket mounting, is approximately 3-11/16 inches in diameter, 3 inches deep, 4 3/8 inches long, and has an approximate weight of one pound. External connections are made through a standard AN type connector.

Brand New \$5.75

DYNAMOTORS—500 Watts Navy Type CAJO-211444

Input: 105-130 Volts D.C., 6 amps. Output 13 or 26 Volts D.C. (26 V. at 20 amps. in series or 13 V. at 40 amps. in parallel). Designed for radio use, fully R.F. filtered, complete with separate Square D line switch box.

BRAND NEW \$59.50

SOUND POWERED CHEST SETS



No Batteries Required
Ideal for television installers, or any antenna measurement work. Leaves hands free to make adjustments. Set consists of microphone and headset as illustrated.

Brand New Per Set \$19.50

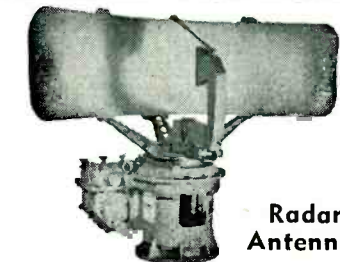

Radar Antennas

Following types available

- | | | |
|----------------|-------|----------|
| SO-1 (10 cm.) | | \$149.50 |
| SO-3 (3 cm.) | | \$139.50 |
| SO-8 (10 cm.) | | \$139.50 |
| SO-13 (10 cm.) | | \$129.00 |
| TDY (10 cm.) | | \$95.00 |

All Brand New

TRANSTAT VOLTAGE REGULATOR

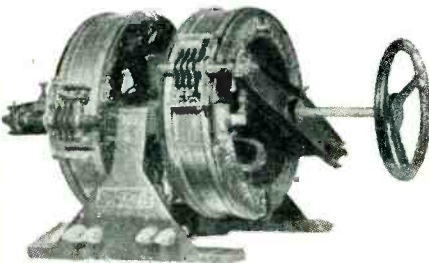

Max KVA Output.....11.5
Single Phase.....50-60 Cycles
Fixed Winding.....115 Volts
Commutator Range.....0-115 Volts
Max. Amperage.....100
With reconnection for 220 V. Operation:
Max Amperage.....50

This Transtat has wide application to control temperature, motor speed, illumination, rectifier output, filament supply, voltage compensation, instrument calibration, and general testing and laboratory use.

Net weight 134 Lbs. Dim. 25" W x 16" D x 17 1/2" H (Exclusive 8" shaft extension)
Brand New.....\$75.00

SYNCHROS

(Selsyns, Autosyns, etc.)

Navy types: 1F, 5B, 5CT, 5DG, 5G, 5F, 5SDG, 5SG, 5SF, 6DG, 7G, etc.

Army types: 2J5FB1, 2J5S1, 2J1F3, CAL 18300, C 78414, C 78863, C 78411, etc.

Pioneer Precision Autosyns type AY 101D.

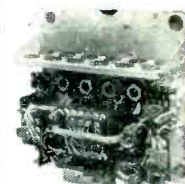

400 CYCLE SERVO AMPLIFIERS

G. E. Type 2CV1C1

Brand New \$29.50

Prices FOB, Tuckahoe, N. Y.
Subject to Change Without Notice. 20% With Order on C.O.D. Shipments.

5 WAVERLY PLACE

ELECTRONICRAFT

INC.

PHONE—TUCKAHOE 3-0044

TUCKAHOE 7, NEW YORK

All merchandise guaranteed. Immediate delivery, subject to prior sale.

SAVE — Brand New and Fully Guaranteed

SYNCHROS

- If Special Repeater, 115 volts, 400 cycle. Will operate on 60 cycle at reduced voltage.—**Price \$15.00 each net.**
- ICT Control Transformer, 90/55 volts, 60 cycle.—**Price \$22.50 each net.**
- 2J1G1 Control Transformer, 57.5/57.5 volts, 400 cycle.—**Price \$2.00 each net.**
- 2J1H1 Selsyn Differential Generator, 57.5/57.5 volts, 400 cycle.—**Price \$3.25 each net.**
- 5G Generator, 115 volts, 60 cycle.—**Price \$25.00 each net.**
- W. E. KS-5950-L2, Size 5 Generator, 115 volts, 400 cycle.—**Price \$4.50 each net.**
- Size 5 Generator, Army Ordnance Drawing No. C-78414, 115 volts, 60 cycle.—**Price \$14.00 each net.**

PIONEER AUTOSYNS

- AY1, 26 volts, 400 cycle.—**Price \$4.00 each net.**
- AY20, 26 volts, 400 cycle.—**Price \$5.50 each net.**
- AY30, 26 volts, 400 cycle.—**Price \$10.00 each net.**
- AY31, 26 volts, 400 cycle. Shaft extends from both ends.—**Price \$10.00 each net.**
- AY38, 26 volts, 400 cycle. Shaft extends from both ends.—**Price \$10.00 each net.**

PIONEER PRECISION AUTOSYNS

- AY131D, new with calibration curve. **PRICE—WRITE OR CALL FOR SPECIAL QUANTITY PRICES**
- AY131D, new with calibration curve.—**Price \$35.00 each net.**

GENERAL ELECTRIC D. C. SELSYNS

- 8TJ9-PDN Transmitter, 24 volts.—**Price \$3.00 each net.**
- 8DJ11-PCY Indicator, 24 volts. Dial marked -10° to $+65^{\circ}$.—**Price \$4.00 each net.**
- 8DJ11-PCY Indicator, 24 volts. Dial marked 0 to 360° .—**Price \$6.50 each net.**

PIONEER TORQUE UNITS

- Type 12602-1-A.—**Price \$30.00 each net.**
- Type 12606-1-A.—**Price \$35.00 each net.**
- Type 12627-1-A.—**Price \$70.00 each net.**

PIONEER TORQUE UNIT AMPLIFIER

- Type 12073-1-A.—**Price \$17.50 each net.**

RATE GENERATORS

- PM2, Electric Indicator Company, .0175 V. per R. P. M.—**Price \$7.25 each net.**
- F16, Electric Indicator Company, two-phase, 22 V. per phase at 1800 R. P. M.—**Price \$12.00 each net.**
- B-68, Electric Indicator Company, Drag Cup, 110 volts, 60 cycle, one phase.—**Price \$14.00 each net.**

INVERTERS

- 12117-4, Pioneer. Input 24 volts D. C. Output 26 volts, 400 cycle.—**Price \$12.00 each net.**
- 12117, Pioneer. Input 12 volts D. C. Output 26 volts, 400 cycle.—**Price \$15.00 each net.**
- 12123-1-A, Pioneer. Input 24 volts D. C. Output 115 volts, 400 cycle, 3 phase. Voltage and frequency regulated. 100 V. A.—**Price \$75.00 each net.**
- 153F, Holtzer Cabot. Input 24 volts D. C. Output 26 volts, 400 cycle, 250 V. A., and 115 volts, 400 cycle, 3 phase, 750 V. A. Voltage and frequency regulated.—**Price \$150.00 each net.**
- WG750, Wincharger, PU16. Input 24 volts D. C. Output 115 volts, 400 cycle, 1 phase, 6.5 amps. Voltage and frequency regulated.—**Price \$35.00 each net.**
- 149H, Holtzer Cabot. Input 28 volts at 44 amps. Output 26 volts at 250 V. A. 400 cycle and 115 volts at 500 V. A. 400 cycle.—**Price \$39.00 each net.**
- 149F, Holtzer Cabot. Input 28 volts at 36 amps. Output 26 volts at 250 V. A. 400 cycle and 115 volts at 500 V. A. 400 cycle.—**Price \$29.00 each net.**

SPERRY PHASE ADAPTER

- Type 661102, 115 volts, 400 cycle. Used for operating 3 phase equipment from a single phase source.—**Price \$6.50 each net.**

SINE-COSINE GENERATORS

(Resolvers)

- FJE 43-9, Diehl, 115 volts, 400 cycle.—**Price \$20.00 each net.**

D. C. ALNICO FIELD MOTORS

- 5067127, Delco, 27 V., 250 R. P. M.—**Price \$2.90 each net.**
- 5069600, Delco, 27 V., 250 R. P. M.—**Price \$4.00 each net.**
- 5069466, Delco, 27 V., 10,000 R. P. M.—**Price \$3.00 each net.**

WRITE FOR COMPLETE LISTINGS

D. C. MOTORS

- 5069625, Delco Constant Speed, 27 volts, 120 R. P. M. Built-in reduction gears and governor.—**Price \$4.25 each net.**
- A-7155, Delco Constant Speed Shunt Motor, 27 volts, 2.4 amps., 3600 R. P. M., 1/30 H. P. Built-in governor.—**Price \$6.25 each net.**
- 5BA10J18D, General Electric, 27 volts, 0.7 amps., 110 R. P. M.—**Price \$2.90 each net.**
- 5066665, Delco Shunt Motor 27 volts, 4000 R. P. M. Reversible, flange mounted.—**Price \$4.50 each net.**
- C-28P-1A, John Oster Shunt Motor, 27 volts, 0.7 amps., 7000 R. P. M., 1/100 H. P.—**Price \$3.75 each net.**

A. C. MOTORS

- 5071920 Delco, 115 volts, 60 cycle, 7000 R. P. M.—**Price \$4.50 each net.**
- 36228, Hayden Timing Motor, 115 volts, 60 cycle, 1 R. P. M.—**Price \$2.85 each net.**

SERVO MOTORS

- CK1, Pioneer, 2 phase, 400 cycle.—**Price \$10.00 each net.**
- CK2, Pioneer, 2 phase, 400 cycle.—**Price \$4.50 each net.**
- FPE-25-11, Diehl, Low-Inertia, 75 to 115 V., 60 cycle, 2 phase.—**Price \$16.00 each net.**
- FP-25-2, Diehl, Low-Inertia 20 volts, 60 cycle, 2 phase.—**Price \$9.00 each net.**
- FP-25-3, Diehl, Low-Inertia 20 volts, 60 cycle, 2 phase.—**Price \$9.00 each net.**

GYROS

- Schwein Free & Rate Gyro type 45600. Consists of two 28 volt D. C. constant speed gyros. Size 8" x 4.25" x 4.25".—**Price \$10.00 each net.**
- Schwein Free & Rate Gyro, type 46800. Same as above except later design.—**Price \$11.00 each net.**
- Sperry A5 Directional Gyro Part No. 656029, 115 volts 400 cycle, 3 phase.—**Price \$17.50 each net.**
- Sperry A5 Vertical Gyro. Part No. 644841, 115 volts 400 cycle 3 phase.—**Price \$20.00 each net.**
- Sperry A5 Amplifier Rack Part No. 644890. Contains Weston Frequency Meter. 350 to 450 cycle and 400 cycle, 0 to 130 voltmeter.—**Price \$10.00 each net.**
- Sperry A5 Control Unit Part No. 644836.—**Price \$7.50 each net.**
- Sperry A5 Azimuth Follow-Up Amplifier Part No. 656030. With tube.—**Price \$5.50 each net.**
- Pioneer Type 12800-1-D Gyro Servo Unit. 115 volts 400 cycle, 3 phase.—**Price \$15.00 each net.**
- Norden Type M7 Vertical Gyro. 26 volts D. C.—**Price \$20.00 each net.**
- Norden Type M7 Servo Motor. 26 volts D. C. **Price \$20.00 each net.**

INSTRUMENT ASSOCIATES

147-57 41st AVENUE Telephone INdependence 3-1919 FLUSHING, N. Y.

AND-EYEFULS OF ELECTRONIC SPECIALS TOO!



BC 1072 A IFF X'MITTER

in MAPLE CHEST 150 to 200 Mcs. 115 V. 60 Cyc.

POWER SUPPLY gives: 0-5000 v.d.c. (variac control) 312 v.d.c., 700 v.d.c., 6.3 vac. Also contains: 11 tubes 6J5, 826, 6SN7, 5U4G, etc.), 5 KV meter, Blower, Condensers and many other useful parts too numerous to list. Shipping Wt. 245 lbs.

Only (slightly used) \$22.50

PULSE TRANSFORMERS

Philco 352-7250-2A, 15/16 dia. x 1 1/2" High D.C. Resistance, 10 ohm 3 1/2 ohm. sine wave response 3db. 140 cy to 175 kc for long pulses (30 microseconds) (Can be used for vertical blocking in TV) \$1.25
 800 KVA GE. No. 7710417, 50 ohms pulse cable connection, 450 ohm output, 9500 volt input, 28000 V. pk. output, Bifilar. 19.50
 300 KVA GE. 7557296, 50 ohm pulse cable connection; 3.850 V. in 17,300 V. out (250 KVA @ 1/2 micro second) 15.00
 Western Electric Permalloy Core, 150 turns, No. 33 AWG. Primary and 150 turns secondary. Toroidal windings, D166638, 1 3/4" x 1 1/4" x 2 3/4" 1.25
 UTAH X 124 T-2 (9280, 9262). (Can be used for horizontal blocking oscillator in TV) X 143 T-1 1.50

TRANSFORMER

V.E. ± D 166173 high voltage input transformer, impedance 50 to 900 ohms. Frequency 10 Kc. to 2 Mc. 5 1/2" dia. x 7 7/32" high for APQ-13 \$12.00

UNIVERSAL JOINT

ALUMINUM

1 1/2" long x 1/2" O.D. 1/4" I.D.

35¢

POSTAGE STAMP MICAS

5MMF	60MMF	220MMF	560MMF	.0027*MFED
8-2	30	300	.003*	.003*
10	82*	360	.003*	.003*
20*	90	390*	.0039*	.0039*
22	110*	400	.004*	.004*
39	150*	470	.0047*	.0047*
47	180*	488*	.0048*	.0048*
50	185*	500*	.005*	.005*
56	200	525*	.00525*	.00525*

Price schedule

5MMF to .001MFED	— 5¢	Silver Mica	10¢
.0012MFED to .0027MFED	— 7¢	Silver Mica	20¢
.0029MFED to .0068MFED	— 12¢	Silver Mica	50¢
.0082MFED	— 16¢	.01MFED	18¢

DELAY NETWORKS. 1400 ohm, in small cans (look like I.F.) made up with ceramics and R.F. chokes. Ideal for making pulse generators, etc.

T113—approx. 1.2 micro second delay 85¢
 T114—approx. 2.2 micro second delay 85¢
 T115—similar to T114 with ten brought out 85¢

Mica Switch—Normally open SPST, push button type 45¢—10 for \$4.00

50¢ ALLEN BRADLEY TYPE J POTENTIOMETERS 50¢

Linear Taper

Resis.	Shaft	Bushing	Length	AB No.	100K OHMS	7/16"	3/8"	433196-4
500 OHMS	1/4" SD	1/4"	M440424-12	100K OHMS	1/4" SD	3/8"	440424-29	
1.5K OHMS	5/16" SD	1/4"	430116-9	100K OHMS	1/4" SD	1/4"	430116-26	
2K OHMS	1/4"	1/4"	440424-11	100K OHMS	3/8" SD	3/8"	253729-15	
2.5K OHMS	1/8" SD	3/8"	M254161-2	500K OHMS	1/8" SD	1/2"	CBZ631497-10	
25K OHMS	1/8" SD	1/4"	252729-36	250K OHMS	1/8" SD	1/4"	253729-21	
10K OHMS	1/8" SD	5/8"	CBZ631623-10	1 MEG.	1/8" SD	1/2"	427471-1	
25K OHMS	1/2"	1/2"	2275-CRA	2 MEG.	3/8" SD	1/2"	9032105	
50K OHMS	1/4" SD	1/4"	440424-13	"SD" indicates slotted shaft for screw driver				

MINIMUM ORDER \$3

All Orders f.o.b. PHILA., Pa.

RELIANCE MERCHANDIZING CO.

Arch St. Cor. Croskey, Philadelphia 3, Pa. Telephone Rittenhouse 6-4927

OIL FILLED CAPACITORS

MFD	V.D.C.	Price	MFD	V.D.C.	Price
.1	25,000	\$14.95	.2	750 V.A.C.	.49
.375	16,000 and 1.75		10	2,000 V.D.C.	4.25
.1	12,000	4.95	10	1,000	1.75
.1	7,500	12.50	8	1,000	1.50
.1	7,500	1.95	4	1,000	1.00
.1-1	7,000	2.45	3	1,000	.80
.02	7,000	1.85	2	1,000	.65
.02-.02	7,000	1.55	.05	1,000	.29
.1	6,000	1.75	1	800	.40
.03-.03	6,000	1.65	4	600	.69
.1	6,000	9.50	2	600	.39
.01	5,000	1.35	1	500	.29
.25	3,000	1.75	.5	500	.24

FILAMENT TRANSFORMER

WESTINGHOUSE #6D4298

Tested at 34,000 volts

Pri. 115 V. A.C., Sec. 5V @ 6.5 Amp.

ONLY \$8.50



CHOKES

400 MA. 12 Henry 90 Ohms, 6,000 V.D.C. Test. Hermetically Sealed. 4 1/2" x 5 1/2" x 4 1/4", 12 lb. \$3.85
 110MA. 9 Henry 3" diameter x 4" high \$1.20

ALLEN SET SCREWS

4-40x1/8	6-32x1/8	10-32x1/4
4-40x3/16	8-32x1/8	1/4-20x1/2
	8-32x3/16	1/2-16x3/8

All sizes \$1.50 per C
 Wrenches (2-56 out of stock) 2¢ each
 Allen Socket Head Screws, stainless steel, 10-32 size 3/8", 1/2", 1 1/8" \$3 per C

Wrapped—BALL BEARINGS—New

Mfg.	ID	OD	Width	Price
Fafnir 33K5E	3 1/16"	1 1/2"	5/32"	25¢
ND 38	5 1/16"	1 3/64"	9/32"	45¢
Timken	1 1/2"	1 3/8"	7/16"	85¢
ND5202C13M	1 1/2"	1 3/8"	1 3/8" (dual)	1.25
ND 85653	43/64"	1 37/64"	21 3/32"	1.00
MRC 206SF	1 5/32"	2 7/16"	5/8"	1.25
Fafnir 545	2 1/6"	2 5/8"	15/32"	1.00

NEEDLE BEARINGS

B88	1D	OD	Price
B88 1/2" wide	1/2"	11/16"	25¢
B108 1/2" wide	5/8"	13/16"	30¢
GB34X 1/4" wide	3/16"	11/32"	25¢

HARDWARE ASSORTMENT—(mostly brass)—screws, nuts, washers, solder lugs, etc. 3 lbs. \$1.00

SLIP RING ASSEMBLY—5 silver plated rings on molded bakelite rotor. Stator holds 2 silver carbon brushes for each ring. Rotor 3/8" O.D., fits 1 1/4" shaft. Complete with brushes \$2.95

BRASS BINDING POST screw down with 8-32 mounting screw, per hundred . . . \$5.00

HANDLES—Brass 5/16" round stock, 4 3/4" long, 1 1/2" high, black, tapped 8-32 . . . 10 for 70¢

GEAR REDUCTION BOX—Aluminum housing, 16 1/2-1 ratio, 5 1/4"x3 3/4"x6" plus couplings & base \$5.00

Aircraft Galley Kit—From B-29—Contains Two 1/2 gal. food warmers with Stainless lids. Operated on 115V., 60 Cyc or 24 V.D.C., grill and chrome-plated soup warmer 24 V.D.C.; salt & pepper shakers; sugar dispenser; A.C. & D.C. line cords; canvas cover . . . \$15.00

RG 8/U NEW-UNUSED

52 OHM

COAXIAL CABLE

4¢ A FOOT

500-2,500 feet	\$40.00 per M
3,000-5,000 feet	35.00 per M
3,500-10,000 feet	30.00 per M
10,500-20,000 feet	27.50 per M
over 20,000 feet	25.00 per M

No charge for reels.

COAXIAL FITTINGS

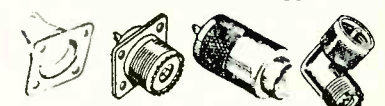

Hood 10¢ Socket 40¢ Plug 40¢ Angle Adaptor 20¢
 S0-239 83-IR PL-259 83-ISP M-359 83-IAP

PL259A, 83-ISP, 83-1J, UG21U, UG22U, G, UG85U Baby "N" plugs . . . 40¢ each
 Fittings, UG85U Baby "N" plugs . . . 40¢ each
 UG87U Baby "N" Socket, Gold Plated with Hood Attached . . . 50¢ each
 83IT, Tee . . . \$1.25 each

PRECISION RESISTORS

1% OR BETTER



Any Order For 100 pieces . . . 10% Off 1000 pieces . . . 20% Off

1/4 WATT—25¢				
6.68	12.32	16.37	123.8	414.3
10.48	13.02	20.	147.5	705.
10.84	13.52	62.54	220.4	2193.
11.25	13.89	79.81	301.8	10,000.
11.74	14.98	105.8	366.6	59,148.

1/2 WATT—25¢				
.250	11.1	235	4,451	15,000
.384	13.15	260	5,000	15,750
.502	46	270	5,900	17,000
.557	52	298.3	6,500	20,000
.627	55.1	400	7,000	25,000
.76	75	723.1	7,500	30,000
1.01	97.8	2,500	8,000	100,000
1.53	125	2,850	8,500	150,000
2.04	180	3,127	10,000	
2.25	210	4,000	14,825	

1 WATT—30¢				
1.01	5.21	1,250	18,000	65,000
2.58	10.1	3,300	20,000	70,000
3.39	10.9	5,000	50,000	75,000
5	100	7,000	55,000	
5.05	270	9,000		

1 WATT—40¢				
100,000	128,000	180,000	470,000	600,000
120,000	130,000	250,000	522,000	700,000
125,000	160,000	320,000	525,000	

1 Megohm, 1W, 1%, 65¢, 5%, 40¢

Mounting Brackets—(Bakelite) for sel-syns and differentials shown below, 25¢ pair

SELSYNS

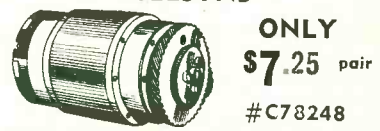

ONLY \$7.25 pair

#C78248

115 V., 60 Cyc., 3 1/4" dia. x 4 1/2" body. Used in Pairs for Remote Control. Also 50 V., 50 Cyc. \$4.75 pair.

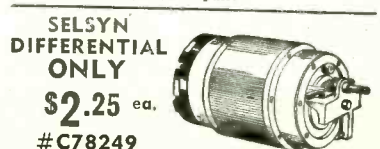

SELSYN DIFFERENTIAL ONLY

\$2.25 ea.

#C78249

115V., 60 Cyc. Used between two #C78248's as dampener. Can be converted to a 3600 RPM Motor in 10 Minutes. Conversion sheet supplied. Also 50 V., 50 Cyc., \$1.50 ea.

PARTS FOR EVERY LABORATORY AND FOR THE SMALL MFR.

FREE RECTIFIER OFFER



these will be sent free with each \$10. ordered leaving 3000 to sell at 39c. each.

#1—This is a full wave bridged selenium rectifier. Input 115 to 130 A.C. Continuous duty. Output 15 milliamperes at 25 volts drop. Less than 25 volt drop if less current is drawn. For instruments, relays, etc. One of these will be sent free with each \$10. ordered leaving 3000 to sell at 39c. each.

#2—THERMOSTAT G. E. 10 AMP.

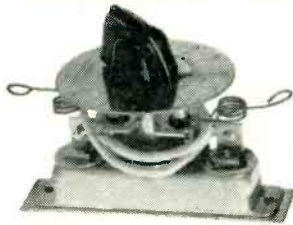

Adjustable to within 1°F. in range 135°F. to 185°F. with scale and knob. Contacts 110 volt. Good for heating wax, compound, in tanks also oven control, etc.—Quantity in stock: 1433. Priced at 59c. ea.

#1—TERMINAL STRIP, 6 TERMINAL



5 x 1" by 1" high overall, hard black bakelite moulded, with 8 x 32 brass studs, 12 heavy brass hex nuts, 6 lockwashers. Good for heavy or light wiring. Mounts on flat surface, insulated for 5000 volts. Handsome appearance, suitable for transmitters, industrial equipment; may be cut down to shorter size cheaply. Quantity: 17,247.—Priced at only 11c. each.



#99A—1600 Mfd. 12 volt. Quantity: 1288. Very Special at 49c. each.

BRAND NEW NAVY SURPLUS 14 INCH RHEOSTATS

Any voltage up to 600 volts—9.2 amperes continuous duty—10 OHMS—EXTRA LONG SHAFT. Can be banked in series or parallel.

#92A—Extra cost feature is linear ampere rating. Every section down to one ohm is wound for same current as the whole Rheostat—9.2 ampere to 9.2 ampere, no drop. Price—\$5.45 ea.

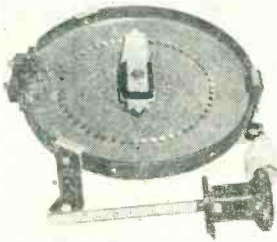

#79A—HEATER VULCAN D5



Ring 2" O.D., 1" I.D. 3/4" thick, fully arched, with outstanding porcelain bushing insulators 3/4" high for two terminal leads, 35W, 55V, designed for two in series on 110V. Excellent for small compound heaters, wax heaters, small enough to hold and pour from. Liquid-proof design, easily installed in any pot or ladle, small tank, stamping die. Quantity in stock: 2,914. Priced at 19c. each.

STOCK UP ON AIRCRAFT LAMPS AT THESE EXCEPTIONAL BARGAIN PRICES

Quantity	Mfgr. Number	Base	List Price	Our Price
3,840	West.hse. 1747	Single Contact 50CP	12-16 V. \$1.05	\$.21
4,800	West.hse. 1745	Single Contact 32CP	12-16 V. .90	.18
2,000	West.hse. 308	Red Double Contact 21CP	28 V. .55	.11
2,400	West.hse. 311	Single Contact 50CP	28 V. .55	.11
1,700	West.hse. 986	Double Contact 2.5 Amp.	28 V. 1.05	.21
5,000	G. E. 77	Single Contact 3CP	12-16 V. .38	.06
28,000	G. E. 78	Double Contact 3CP	12-16 V. .30	.06
5,000	G. E. M306	Double Contact 15CP	28 V. .45	.09
11,000	G. E. 307	Red Single Contact 21CP	28 V. .55	.11
8,000	G. E. M310	Double Contact 32CP	28 V. .55	.11
6,500	G. E. RP11	Flasher 5 Filament GE #1039		
		Single Contact 6.6 Amp.	13 V. .50	.10
34,000	Tung-Sol 302	Double Contact 3CP	28 V. .30	.06
1,600	Tung-Sol 304	Double Contact 6CP	28 V. .35	.07
366	Tung-Sol 311	Single Contact 50CP	28 V. .55	.11

All packed in original package of ten; fifty packages to a carton. Minimum order: 10 of any one number (one package).
Extra 10% discount on any assortment of 1,000
Extra 15% discount on any assortment of 5,000
Extra 20% discount on any assortment of 10,000

#89— CANNON SOLENOID



This item just must be seen and tested to be appreciated. At 6 volts, draws 1-1/3 amperes, has 1/2 pound pull at 3/4 in. stroke; 2 pound pull at 3/4 in. stroke. At 12 volts, draws 2-2/3 amperes, has 1 pound pull at 3/4 in. stroke; 4 pound pull at 3/4 in. stroke. At 24 volts (rated voltage), draws 5 amperes, has 2 pound pull at 3/4 in. stroke; 8 pound pull at 3/4 in. stroke. Very compact, easily mounted. Tapered shaft that goes clear through back of the case. Quantity: 2200—Priced at 69c each—Probably our greatest bargain.

NON-INDUCTIVE RESISTORS

Quan.	Value	Wattage	Length	Price
196	2 Ohms	15	2 1/2"	\$.15
213	10 Ohms	15	2 1/2"	.15
65	10 Ohms	120	9 1/2"	.45
43	15 Ohms	120	9 1/2"	.45
450	25 Ohms	15	2 1/2"	.15
780	40 Ohms	20	3"	.20
72	150 Ohms	120	9 1/2"	.45
20	500 Ohms	15	2 1/2"	.15
140	500 Ohms	90	7 1/2"	.40
255	800 Ohms	120	9 1/2"	.45
165	1000 Ohms	15	2 1/2"	.15
75	2000 Ohms	15	2 1/2"	.15
140	4000 Ohms	20	3"	.20
320	9000 Ohms	35	4 1/2"	.25

PORCELAIN ENAMEL FERRULE

174	10 Ohms	100	9 1/2"	.45
144	15 Ohms	100	9 1/2"	.45
206	150 Ohms	100	9 1/2"	.45

FERRULE

1,100	1.3 Ohms	Type CX	8"	.45
820	18 Ohms	Type A	2 1/2"	.15
22	30 Ohms	Type CX	8"	.40
54	250000 Ohms	Type B	12"	.50
13	300000 Ohms	Type B	10"	.45
39	75 Ohms	Type CX	10"	.45
39	340 Ohms	Type B	12"	.50

Large stock regular W.W. on hand.

#85—G. E. THYRISTE K-522332 (M)

Diameter 3 in. Thickness 1/2 in. Hole 1/2 in.
Good voltage regulator, 3rd harmonic generator.
Current: 5 ma. at 18 volts; 10 ma. at 23 volts. 20 ma. at 29 volts; 40 ma. at 36 volts. Rating: 3 watts maximum in air.
Quantity: 2,808—Priced at 25c. each.
We have sold these at \$1. right along.

#82—G. E. THYRISTE K-8396832-1.

Diameter 1 1/2". Thickness 3/8". Hole 1/2".
Good voltage regulator, 3rd harmonic generator.
Current: 5 ma. at 21 volts 10 ma. at 24 volts 20 ma. at 28 volts 40 ma. at 33 volts
Rating 1 1/2 watt maximum in air.

#80—EDISON FIXED THERMOSTAT

Hermetically sealed. Explosion proof. 135 degrees Fahrenheit, normally closed. Opens above 135 degrees. Sealed in glass. One ampere contacts. Fine for fire alarm system. Another 29c. bargain. Lists for over \$3.00. Quantity in stock: 460.



#12—CARBON PILE VOLTAGE REGULATOR

supplied with 30 watt, 50 ohm slide wire adjustable resistor; the voltage regulator has an even 18 1/2 volt output with a variable input of from 21 to 30 volts D.C. The coil and upper bed make a very EFFICIENT magnetizer if supplied 80 to 100 volt D.C. and an efficient DEMAGNETIZER on 110 A.C. The regulator can be disassembled for the above purpose in less than 1 minute. Can also be used as a small magnetic chuck.—Quantity in stock: 10,500. Special price for both regulator and resistor: 89c.

#4—300 OHM WIRE WOUND POTENTIOMETER

5 watts, 1 3/8" diameter x 5/8" deep. 1/2" shaft above threads. Linear.
Quantity in stock: 1,690—Price 22c.
We also have 437 of the 200 ohms—same price.

SELENIUM RECTIFIER, FULL-WAVE BRIDGE

Up to 90 volt A.C. input, 20 plate, output, 150 m.a. continuous duty.
Special \$1.35 each.
Only 350 available

#76—60 DEGREE FAHRENHEIT THERMOSTAT

Fixed thermostat. Closes at 60 degrees and opens at 65 degrees. 10 ampere contacts. Snap action. Made by Klixon. Excellent for auto heater control. Quantity in stock: 2,500.—We are closing these out at 22c. each, less quantity discounts.

DONGAN Navy Type Ignition TRANSFORMER

Catalogue No. 2705T
This is a 115 watt enclosed job with a 460 volt primary and a secondary of 5000 volt at 20 ma.
Can you adapt it?
Special \$2.45 each

FAMOUS ROBSON-BURGESS CONDENSER TESTER AND CIRCUIT CHECKER

Attractively cased item for use on 110 A.C. or D.C., consisting of 125 volt full-wave bridged rectifier, resistor switch and neon light with six foot line-cord and plug and test leads. This is one of the best inexpensive condenser testers, because it actually puts D.C. current into the condenser.
Regularly \$7.95, our price, while 300 last, \$2.95 each. Original cartons.

TERMS Net 30 days to rated mfrs and to schools. All shipments F.O.B. New York. 20% deposit on C.O.D. orders.

EXCESS INVENTORY CORP.

56 LISPENARD ST.

ELECTRONICS DEPT.
Tel. Walker 5-9135—9136

NEW YORK 13, N. Y.

Finest of surplus
at a fraction of cost

PEAK ELECTRONICS CO.

Industrials
Schools - Labs

50 MICROAMP METER

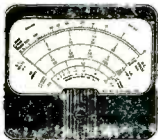

This is the exact meter utilized in the General Electric model YMW-1A Lab-Type Unimeter.

- 50 Microamp Movement $\pm 2\%$
 - 2500 Ohms Resistance $\pm 2\%$
 - Knife-Edge pointer
 - Uncrowded Multi-Range Scale
 - 4 x 4 1/2" Black Bakelite Case
 - 50 Microamp scale available at 25c additional
- BRAND NEW only \$9.75 ea.

METER SPECIALS

- | | |
|------------------------------------|------|
| 2" GE 0-30 amps, D.C. | 2.95 |
| 2" GE 0-1 amp RF (internal thermo) | 2.95 |
| 2" GE 0-5 ma (amp scale) | 1.95 |
| 2" GE 0-1.2 ma (0-100 scale) | 2.49 |
| 2" GE 0-1 ma (v.c. scale) | 2.95 |
| 2" Gruen 0-3V DC (1000 ohms-volt) | 2.45 |
| 2" Weston 150-0-150 Microamps | 3.49 |
| 2" Westinghouse 0-50 amps AC | 4.95 |
| 3" Triplett 0-75 amps AC | 3.95 |
| 3" WE 0-80 ma DC | 2.95 |
| 3" GE 200-0-200 volts DC | 2.95 |
| 3" McClintock 0-1 ma | 3.95 |
| 3" Westinghouse 0-2 ma DC | 3.95 |
| 3" Westinghouse 0-20 ma DC | 3.95 |
| 3" GE 0-15 ma DC (square) | 3.95 |
| 3" Westinghouse 0-150V AC | 3.95 |
| 3" Running time meter 110 v. 60 cy | 7.95 |

DAVEN AUDIO FREQUENCY METER MODEL 837E



Direct readings from 0-30 KC in 4 separate ranges on 6" Weston Model 271 Fan Meter. Built-in voltage regulated power supply operates from 115 volts 60 cycles, has high input impedance. With pick-up can be used to determine frequency in vibration tester. With suitable mixer can check deviation of R.F. carrier from standard. Mounts of 8 1/2"x19" rack panel. Complete with tubes. Slightly used but perfect. Only \$59.50

"A POWERFUL BABY"

This plate transformer built to rigid Signal Corps spec. input 118 volts, 25 to 60 cycles. Has 2 separate 118 volt primaries and can be used on 110 or 220 volts. Secondary 800 volts center tapped at 75 mills. Exceptional regulation even when loaded to 900 milli! Fully cased—4 mtg holes. 37 lbs. net wt. 6 1/2 x 6 1/2 x 7 1/2. Peak value at 7.95. 10 for \$70.00

CHOKO BARGAINS

- | | |
|--------------------------|-------|
| 6 Henry 45 MA 300 ohms | 3.39 |
| 8 Henry 75 MA 230 ohms | 3.59 |
| 8 Henry 160 MA 140 ohms | 1.39 |
| 10 Henry 200 MA 150 ohms | 1.95 |
| 1.5 Henry 250 MA 72 ohms | .60 |
| 10 Henry 350 MA 60 ohms | 3.75 |
| 6 Henry 550 MA 30 ohms | 4.95 |
| 4.3 Henry 620 MA 42 ohms | 4.95 |
| 10 Henry 750 MA 95 ohms | 11.50 |

FILAMENT TRANSFORMER

Two separate 118 volt, 25 to 60 cycle primaries. Can be used on 110 or 220 volts. Secondary 5 volts at 15 amps. Built to Signal Corps specs. Fully enclosed. 5 x 4 1/4 x 5 1/2. Net wt. 10 lbs. \$3.75 each, 10 for \$30.00.

VERSATILE POWER

These transformers have many uses—filament, isolation, stepdown, bias, etc. All have 2 separate primaries for 110/220 volt 25-60 cycle operation. Primaries. Can be used in series or parallel. 3 Choices of Secondaries: Type 501—115 volts 500 mills and 6.3 volts 5 amps. Type 505—115 volts 900 mills and 6.3 volts 2 amps. Type 502—0.70-75 volts at 2.5 amps. (35-37 v. in. series) Fully enclosed—4 mtg. holes. 5 1/2 x 4 1/4 x 5 1/2. Your cost any type. \$1.95 each 10 for \$17.00

AN/APT—2 AIRCRAFT RADAR JAMMER



425-750 mos. Contains 10 tubes: (1)—807 (2)—703A (2)—6AC7 (2)—6AG7— (2)—5R4GY (1)—2x2 (1) 931A Unit has blower motor and 400 cycle pur supply complete with all tubes etc. BRAND NEW.. \$19.95 each

HIGH VOLTAGE—HIGH CURRENT PLATE

1500-0-1500 volts at 1.5 amps. Tapped at 1350 and 1250. Pri. 110/220 volts 50/60 cycles in 2 Separate windings. Built to rigid Navy specs by Amertran. Suitable for broadcast transmitters, induction heating, etc. Size 10" x 10" x 7" s.w. 125 lbs. \$67.50 each.



VARIABLE CERAMICONS

- | | | | |
|--------------|----|---------------|----|
| 1.5 to 7 MMF | 24 | 4 to 30 MMF | 24 |
| 3 to 13 MMF | 24 | 7 to 45 MMF | 24 |
| 5 to 20 MMF | 24 | 10 to 110 MMF | 39 |

AMERTRAN FILAMENT TRANS.

5.25 volts at 21 amps. plus 2 x 7.75 v at 6 amps. Pri. 110 v 60 cy. H.V. Ins. 6" x 5 1/2 x 4 1/2. 7.75

SOLA CONSTANT VOLTAGE

Transformer, input 95 to 130 output 115v. 350 VA. 2.9 amps. 29.95

RECTIFIER FILAMENT

Trans. 2.5 V 10 A Pri. 110 v. 60 cy. H.V. insulation. Cased 29.95

AMERTRAN 500 VOLT PLATE

1000 volt et at 300 ma. Pri. 110 v. 60 cy. 6" x 5 1/2". 6.3 v 21 amps. Hermetically sealed. 110 v 60 cy Pri. 4.75

WE BC 1091A-Radar RF unit—with magnetron, etc., in pressurized tank 59.50

PHASE SHIFT CAPACITOR



4 Stator Single Rotpr. 0-360 Degrees Rotation Only 2.95 each

I-196-B SIGNAL GENERATOR 175-220 Mcs. With Tube and Carrying Case, \$5.95.

STEPDOWN TRANSFORMER

220-110 volts, 110 watts. Fully enclosed. 5 1/2 x 4 1/4 x 5 1/2. 110V. 60 cycle. \$2.49 each

WIRE WOUND RESISTORS

- | | |
|---|---------|
| 5 watt type AA, 20-25-50-200-470-2500-4000 ohms | .09 ea. |
| 10 watt type AB, 25-40-84-400-470-1325-1900-2000-4000 ohms | .15 ea. |
| 20 watt type DG, 50-70-100-150-300-750-1000-1500-2500-2700-5000-7500-10000-16000-20000-30000 ohms | .20 ea. |
| 30 watt type DI, 100-150-2500-3000-4500-5300-7500-18000-40000 ohms | .24 ea. |

1% PRECISION RESISTORS

- | | |
|-------------------------------|------------|
| 200-2500-5000-8500-10000 ohms | \$3.99 ea. |
| 50000-95000 ohms | .49 ea. |
| 100000-750000-1 meg | .89 ea. |

CWI 60 AAG range calibrator and power supply, book, cables, etc. 29.50

H. V. VARIABLES

- | | |
|----------------------|---------|
| 150 MMF .5 Spacing | \$17.50 |
| 250 MMF .5 Spacing | 19.50 |
| 75 MMF .3 Spacing | 9.50 |
| 250 per section .051 | 3.95 |
| 250 per section .1 | 5.95 |

Scope Transformer Hermetically sealed 1.800 volts, 4 ma. 6.3 volts, 9 amp., 2 1/2 volts, 2.5 amps., 5 x 3 1/4 x 3 3/4 \$5.95

W. W. POWER RHEOSTATS

- | | |
|----------------------|-----|
| 25 Ohm 25 watt | .39 |
| 300 Ohm 50 Watt | .69 |
| 50 Ohm 50 Watt | .69 |
| 150 Ohm 50 Watt | .69 |
| Dual 200 Ohm 50 Watt | .89 |

Voltage Regulated Power Supply—input 110 v. 60 cy. Delivers 150 v. DC—Well filtered (3 chokes) uses VR 150 and 6X5. Has extra 6.3 v. winding. Swell for eco's. freq. meters, etc., 16x3 1/2 x 5 with tubes. Only 6.95

HIGH VOLTAGE - HIGH CURRENT LOW PRICE MICA CAPACITORS**

- | | |
|---------------------|-------|
| XR .0001 MMF 5 KV | .75 |
| F2L .0005 MMF 5 KV | .85 |
| F2L .001 MMF 5 KV | 1.39 |
| F2L .0015 MMF 5 KV | 1.69 |
| F2L .003 MMF 5 KV | 1.90 |
| XS .005 MMF 5 KV | 2.50 |
| F3L .007 MMF 5 KV | 2.75 |
| *G1 .0024 MMF 6 KV | 4.50 |
| *.001 MMF 8 KV | 1.75 |
| F3L .002 MMF 6 KV | 3.50 |
| F3L .0025 MMF 6 KV | 3.60 |
| F3L .003 MMF 6 KV | 3.75 |
| *MX .004 MMF 6 KV | 4.95 |
| F3L .0005 MMF 8 KV | 2.90 |
| F3L .006 MMF 8 KV | 3.00 |
| *PL .001 MMF 8 KV | 4.95 |
| F3L .0015 MMF 8 KV | 3.50 |
| F3L .002 MMF 8 KV | 4.00 |
| F3L .0025 MMF 8 KV | 4.50 |
| F3L .003 MMF 8 KV | 5.00 |
| F3L .004 MMF 8 KV | 5.50 |
| F3L .005 MMF 8 KV | 6.00 |
| F3L .01 MMF 8 KV | 6.50 |
| *G2 .0005 MMF 10 KV | 5.95 |
| *G2 .002 MMF 10 KV | 6.95 |
| XA .0005 MMF 12 KV | 4.90 |
| *G4 .008 MMF 12 KV | 26.50 |
| *G4 .0033 MMF 20 KV | 29.50 |
| *G4 .004 MMF 20 KV | 24.50 |
| G4 .001 MMF 25 KV | 32.50 |
| *G4 .0015 MMF 25 KV | 32.50 |
- *All ratings "working-voltage."
Tolerance $\pm 5\%$
**Ceramic case.

MEGOHM METER

Industrial Instruments Model L2AU 110/220 volts 60 cycle input. Direct reading from 0-100000 megohms on 4" meter. Can be extended to 500000 megohms with external supply. Sloping hardwood Cabinet 15" x 8" x 10". Brand new with tubes plus running spare parts including extra tubes. Great value only \$69.95.

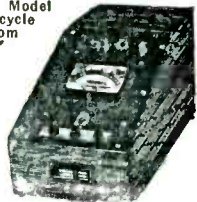

GENERAL RADIO VARIAC 2 KVA

Model 100 Q, 110 v. 60 cy. Inp. 0-135 v. out. 18 amps. BRAND NEW 39.50

SPIERTI RF

VACUUM SWITCH

9200 volts peak, 8 amps. Used as antenna switch in Collins ART 13. BRAND NEW \$13.75



U. H. F. COAX. CONNECTORS

UG12U—831R—831J—UG21U—831AP—831SP .39 ea.

Precision 15 Meg. 1% Accuracy Resistor. Non-inductive, 1 watt, hermetically sealed in glass .39c each; 10 for \$3.50.

OIL CONDENSERS

- | | | | |
|-----------------|-------|---------------------|---------|
| 11 mfd 250 vac | -.85 | 1/.1 mfd 7000 vdc | -2.25 |
| 5 mfd 150 vac | -.49 | 1 mfd 7500 vdc | -1.95 |
| 1 mfd 600 vdc | -.29 | 1 mfd 7500 vdc | -9.25 |
| 2 mfd 600 vdc | -.39 | 4 mfd 8 kv dc | -19.95 |
| 4 mfd 600 vdc | -.59 | .01/.01 mfd 12 kv | dc-5.75 |
| 3/3 mfd 600 vdc | -.79 | .005/.01 mfd 12 kv | dc-5.50 |
| 10 mfd 600 vdc | -.95 | .03 mfd 16 kv dc | -5.75 |
| 14 mfd 600 vdc | -1.35 | .65 mfd 12,500 vdc | -12.95 |
| 2 mfd 1000 vdc | -.79 | .75/.35 mfd 8/16 kv | -12.95 |
| 4 mfd 1000 vdc | -.95 | 3 mfd 3000 vdc | -3.95 |
| 10 mfd 1000 vdc | -2.95 | 1 mfd 5000 vdc | -4.50 |
| 2 mfd 1500 vdc | -1.25 | | |
| 1 mfd 2000 vdc | -1.45 | | |
| 2 mfd 4000 vdc | -5.50 | | |
| 3 mfd 3000 vdc | -3.95 | | |
| 1 mfd 5000 vdc | -4.50 | | |

1 KW TRANSTAT

or Stepdown Transformer
110/220 volts 60 cycle input. Output variable plus or minus 10% of 115 volts at 8.5 amps. Also can be connected to give different voltage combinations. Brand new..... Special 9.95



MIDGET VARIABLE BARGAINS

- | | |
|----------------------------|--------|
| Hammerlund MC 250S 250 mmf | \$.60 |
| Hammerlund MC 320S 320 mmf | .79 |
| Hammerlund APC 100 100 mmf | .39 |
| Bud MC 913 35 mmf. D.S. | 1.25 |
| Hammerlund HF 15 15 mmf. | .39 |
| National TMS 150 mmf. | .79 |

Tremendous stocks on hand. Please send requests for quotes. Special quantity discounts. Price f.o.b. N. Y. 20% with order less rated, balance C. O. D. Minimum order \$3.00.

PEAK ELECTRONICS CO.

188 Washington St., New York 7, N. Y.

PHONE CO-7-6443
DEPARTMENT EA
SEND FOR BULLETIN

SURPLUS—CLEARANCE SALE—CHOICE ELECTRONICS!



5-Meter Walkie-Talkie

Model BC-322 Transceiver; simple, popular communications unit. Freq. range 52-63 mc. Uses only two tubes, types 33 and 30. Includes a 5 mc. crystal in a crystal calibrator circuit. Range 5 to 50 miles, depending upon location and altitude. Operates from single battery block (not supplied) available from mfr., or other sources. Supplied with handset, less antenna, battery. Excellent condition.

PRICE, EACH \$20.95

Telescoping Antenna for Above \$2.00

12 V.D.C. P.A. SYSTEM

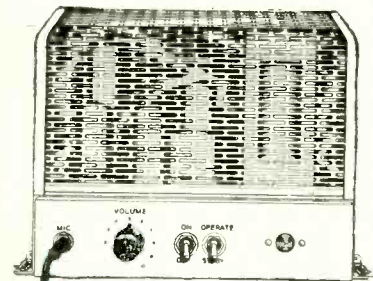

- 25 watts peak power output amplifier.
- Powered from 12 volt storage battery, drain 6 amps. "operate" and only 2 amps. in "standby."
- Mfd. by RCA, supplied with RCA close-talking Dynamic microphone, miscellaneous accessories and instruction booklet.
- Output Impedance—15 ohms (2—8 ohm speakers).

Ideal for sound trucks, portable amplifier requirements, boat or ship installations, etc. Beautifully constructed, shock mounted, and compact. Dim: 11 3/4" x 8" x 6 3/4". Uses a 6J7 driving a 6SN7-GT, driving 2-6L6 beam power tubes. Self-rectifying 12 volt Vibrapak within amplifier. Equipment is New, surplus, and guaranteed. With tubes.

PRICE, with misc. accessories and DYNAMIC MICROPHONE \$54.75

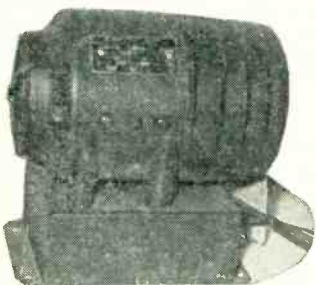

32 VDC 110 AC CONVERTER

Mfd. by Kato Engineering, for marine or farm installation. Rotary type, compact and ruggedly built for continuous duty. Rubber shock mounting on filter case, with complete input and output filtering. Output 110 volts, 60 cycles AC, 225 KVA, but will operate efficiently on loads up to 300 watts. New units only.

PRICE, EACH \$39.95
Quantities, 10 or more, Each \$32.00

RADIO TRANSMITTERS
Immediate Delivery from Stock

BC-325 Transmitter, 400W.-A1, 100 W.-A2 & A3. 1.5 to 18.0 mc. M.O. or X'rad control on 6 frequencies. Operates from 110/220/1/60c. AC. With tubes in excellent condition.

PRICE, EACH \$400.00

BC-447, 300 W. A1, 2-Channel Transmitter. Complete and self-contained in one cabinet, 36x29x7 1/2". H. includes RF sections, power supplies, and control equipment. Freq. range 4.0 to 13.4 mc. Operates from 110/220/V/1/50-60. AC. With tubes. Excellent condition.

PRICE, EACH \$425.00

TCR—Radiomarine Transmitter, 125 watts (conservative) A1, A2, & A3. For ship or shore station radio telephony, 6 channels in 2 to 3 mc band controlled by remote control box supplied. Complete RF, modulator and power supply (for 110 or 220 V. 50/60 cycles AC) in one cabinet. Excellent condition, with tubes and remote control box.

EACH \$500.00

BC-319-A Transmitter, CW only 300 watts output. Freq. range 4.0 to 13.4 mc. Operates from 110/220 volts, 60 cycles AC. Excellent condition. Less tubes. PRICE, EACH \$300.00

Wilcox, 96-200A 2-KW RF section. Large cabinet with complete RF end containing the VFO, intermediate sections and PA stage. Almost new, but lacks PA inductance only. Power supply separate unit not available, but can be built. Less tubes. PRICE, EACH \$500.00

RMCA 8023 HF Ship Transmitter, 200 watts output. A1 and A2. Freq. range 4.0 to 20 mc. Operates from mg set (not supplied) in RF main transmitter (RMCA type 8024). With tubes, but no radio receiver. Excellent cond. PRICE, EACH \$350.00

MACKAY SHIP TRANSMITTERS. The following Mackay ship-radio types are available: 150-A.Y., 151-A1, 149-A, 136-A, 104-M, 147-M. Some new, most in excellent condition. Write for prices.

LINK FM Transmitter-Receiver, 70-100 MC. Model 1498 DC, Wall style cabinet containing transmitter, receiver and 14 V.D.C. power supply, handset. Dim: 31" x 21" x 11". NEW CONDITION. Complete with tubes, crystals, special telescopic antenna, instruction book. 50 W. output. PRICE EACH, \$600.00

NOTICE: Price quoted above do not include crating or packing. Price for packing will be quoted upon specification as to whether export or domestic packing is desired.

BC-620 FM Transmitter-Receiver. Mobile or portable unit main part of SCR-510. NEW, with tubes and complete crystals but less accessories or power supply (operates from batteries or vibrator power supply). Export packed. PRICE EACH \$50.00

BC-603, 604, 683, 684 Transmitters. Receivers. Main components of SCR-508, 528, and 608, 628 FM mobile installations. Dynamotor and tubes supplied.

PRICE, New BC-603 Receiver, w/dynamotor and tubes \$40.00

PRICE, Used but excellent condition \$50.00

PRICE, New BC-604 Transmitter, w/dynamotor, tubes, crystals \$50.00

BC-683 Receiver, New w/dynamotor and tubes. EACH \$10.00

BC-684 Transmitter, New w/dynamotor, tubes and crystals. EACH \$50.00

BD-72 Switchboards, 12-position field switchboards. New and complete, packed two to case. EACH \$60.00

SB-14/GT Large Airport Switchboard. With separate power supply, operates from 110V AC, 50-60 cycles, to charge telephone batteries and operate switchboard. Both in handsome metal cabinets, approx. 50" high, 30" wide and 22" deep. New eqpt. PRICE, per Switchboard and Power Supply \$300.00

MISCELLANEOUS SPECIALS

APQ2 Transmitter, only, with tubes. Almost New. Each \$37.50

SN-1/APQ5 Synchronizer, with tubes. Almost New. Each \$37.50

Collins Autotune Remote Control Unit, Type COL 23377. Has 10-position dial selector for remote control of transmitters, plus two meters for channel indication and volume level, and speech amplifier stages with limiter stage. Good cond. EACH \$25.00

TA-12B 4-Channel Aircraft Transmitters, less dynamotor and accessories, but with tubes. Excellent condition. EACH \$40.00

SCR-551-T2 D.F. Equipment, consists of large metal cabinet with radio receiver Nat'l NC-100-A, Input Amplifier and Electronic Switch, Oscilloscope and DC Amplifier (for visual DF indication), plus self-contained 110v. 60 cycle AC power supply. With tubes, no other accessories or loop. Excellent cond. PRICE, EACH \$210.00

Radio Receiver BC-1066-A, part of Test Eqp't. IE-46-A. Covers "I" and "G" bands. Battery operated. With tubes, but less batteries or phones. Excellent condition \$25.00

Signal Generator, Model 75-E, made by Measurements Corp. of Boston. Range 50-75 MC, but can easily be converted. Includes microvoltmeter for regulating output, tubes, and calibration chart. Operates from 110v. 50/60 cycles AC. Excellent condition. PRICE, EACH \$50.00

EXTRA SPECIALS!!

1100 Lbs. #18 DCC Magnet Wire, per lb. (lot price) \$37.2c

1,600 mfd, 15W.V.D.C., approx. 10,000, lot price, Each \$20c

VT-127A, platinum grid tubes. New. Each \$2.50

Antenna Relays, GM 4P-DT, 250 ohms. Each .95c

Arlake Time Delay Relays, type 902-72-1, 220V, 50/60 cycles, normally open. EACH \$4.95

Same as above, but type 1040-65-4, 110 Volts. Each \$3.45

Amertran Reactor, type W, .04 H., 10Kv. RMS test, 120 cycles, DC resist. 0.24 ohms, 2.4 amps. Each \$3.95

Triple Potentiometers, 80 ohms per section, 2 Watts each section for attenuators, etc. Each \$9.00

Allen-Bradley dual pots, type J, 25M/2M, 1-watt. Each \$5c

Same as above, but 5M/2M. Each \$5c

Standard Brand Capacitor, type 23F47, 2 mfd/4,000 Volts. Each \$3.95

Standard Brand Capacitor, M-7466764-2, 2 mfd/15,000V. Each \$9.75

Minimum Acceptable Mail Order—\$10.00

SCR-536 HANDY-TALKIES

We have just a few of these popular Handy-Talkies, and they won't last long. All are in very excellent condition, and complete with crystals (receiving and transmitting) and batteries. All are in top operating condition, and preset at various operating frequencies ranging from 3.5 to 6.0 mc. Some available for operation in 80 meter ham band. We will supply units with matched frequencies as long as quantity permits. First come, first served!

PRICE, EACH \$49.50

Extra Set Batteries (A&B) \$2.50



FREQUENCY METER
TS-69/AP

Frequency range 400 mc to 1,000 mc, continuous. Ideal for labs, schools, or for ham experimenting with eqpt. for civilian phone band. Black-crackle finished metal case, dim: 6" x 6" x 2 1/2", contains variable length coax resonating cavity with crystal rectifiers and 0-200 microammeter. Veeder-Root counter and calibration charts insure extreme precision. Telescopic antenna, and coax line probe, with metal carrying case for entire equipment. New equipment.

COMPLETE, EACH \$42.50

AMPLIDYNE MG SET
Motor 110/220, 60 C. A. C.

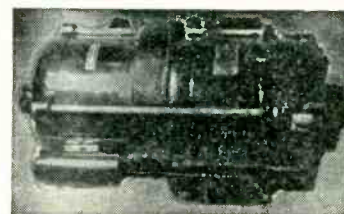

For Automatic or Remote Control of heavy equipment, Mfd. by General Electric. Generator is Type V-5875677, motor 73A158; Navy type CG-21A1B1. Generator delivers 250 volts, DC, 375 watts. Motor, 115 or 230 volts 1-phase, 60 cycles AC, rated at 1/2 HP 115M-1725. Includes capacitor for starting, and instructions for 115 or 230 volt connections. Generator section can be removed, and entire assembly shortened to make valuable 1/2 H.P. AC motor. Quantity sufficient to warrant this conversion.

PRICE, EACH \$50.00

DECK ENTRANCE INSULATORS
Bowl and Flange Type

Manufactured by GILLO BRASS CO. for Army and Navy use. Has heavy galvanized metal flange 8 3/8" diameter, porcelain bowl set in rubber gaskets, top bell is 6 1/2" in diameter. Brass feed-thru rod 1 1/2" long. Insulation distance between top bell and flange is 4 1/2". Individually packed in cartons. Quantities available.

NEW, price each \$2.75

Spare porcelain bowl, only, each \$.75

Phone—
LONGACRE 4-4490-1

All Prices F.O.B. N.Y.C.

All Material Offered Subject to Prior Sale

TELEMARINE COMMUNICATIONS COMPANY

280 Ninth Ave.,
N. Y. 1, N. Y.



BIG VALUES IN SUR

"TRANSTATS"

Amertran Voltage Regulator

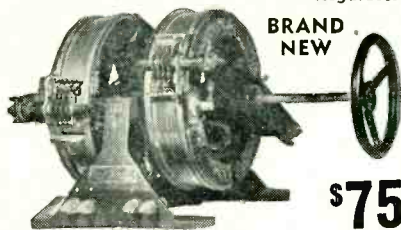

BRAND NEW

\$75

11.5 KVA: 50/60 cy. Commutator Range 0-115 V. Max. Amp. 100. Can be reconnected for 230 volts @ 50 Amperes.

WESTINGHOUSE MOTOR

#1171198-1.4 Horse Power 21 Volt, 70 Amps. 1800 RPM Pump mounting on each end Ball bearing, compound wound 18" L x 8" H x 7" W.

BRAND NEW \$8.50

OIL FILLED CAPACITORS

Table listing various oil-filled capacitors with their specifications and prices.

MICA CAPACITORS

Table listing various mica capacitors with their specifications and prices.

A.C. CAPACITORS

Table listing various A.C. capacitors with their specifications and prices.

RELAYS

Table listing various relays with their specifications and prices.

HEAVY DUTY RESISTORS

Table listing heavy duty resistors with their specifications and prices.

WEST. WATTMETERS (NEW)

Table listing West. wattmeters with their specifications and prices.

WESTINGHOUSE FLEXARC WELDERS

Transformer type, for single operator. These welders have been used but are in the same condition as new. Fully guaranteed to operate satisfactorily. Operates at primary input of 440 or 550 volts, AC, single phase. Has output of 500 amperes. Unit has current adjustment to fit wide range of work. Machines have low input KVA and high power factor giving more welding amperes output for a given input KV-a or line capacity. Welders are of sturdy construction enclosed in heavy sheet steel, providing mechanical protection to the windings and internal connections. Unit is self cooling and has built in circuit breaker to de-energize the welder and also to give overload and short circuit protection.

Special Price \$125

WESTON PORT. VOLTAMMETER



Model 280. Two Ranges 3 / 15 / 150 Volts and 3 / 15 / 30 Amperes. Accuracy 1%. Complete with black leather-carrying case. Brand New. Special \$21

60 CYCLE TRANS. AND CHOKES

G.E. #68G457: Pri. 110V 60 Cy. Sec: 1/1.5/3/6-7.5/10 Volts. \$1.75
G.E. #68G450: Pri. 500/250V 60 Cy. Sec: 2.5V 7.5V 15V 30V \$1.75
G.E. #68G449: Driver Trans. for 7G Synchro Drive. Pri: 200V 60 Cy. Sec: 260VCT \$1.25
Rag. ean Interstage UX8412: Pri. Minus 40 Volts, 40 c Ph. 40 Volts Test 1250V 1KMS. \$40c
Lorgan #2140: Pri. 115V 60 Cy. Sec: 11V 100MA \$1.65c
Amer. Trans: Pri. 115V 60 Cy. Sec: 5V 5.0A. 5V 10.0A. Test Volts 35000. \$15.00
Bathson DC RC Choke 1X888TD: 30 Henries 30MA. Test Voltage 12,000 RMS. \$1.00
Fudat #TRI060: Pri. 300 Ohms. Sec: 250,000 Ohms. Freq. Response 400-3600 Cy. \$50c
Thermador Bias #CS8706: Pri. 200/220/240V 50-60 Cy. Sec: 160V 100MA, 2000V Test. \$95c
Chicago Sec. Current Trans: 3 Ph. 60 Cy. Ratio 5:5 Amps. Consists of 3 Single Phase Trans. in 1 Frame. S. Burden 36 Ohms. Test Volts 2,000VAC. \$4.00
K.V. Fil. Trans: Pri. 115V 60 Cy. Sec: 5V 20A. 20,000V Test. 5V 10A 35,000V Test. \$15.00
Oscilloscope Oscillator Trans: 3 Micro-Seconds. 4 Windings 1:1 Ratio Each Winding. \$1.00

POTENTIOMETERS and RHEOSTATS

#5697: 10K/10K 4W Screw Shaft W.W. 3/\$1.00
#5673 15K JW 1 1/2" Shaft W.W. 4/\$1.00
#5149: 5K 4W Screw Shaft W.W. 4/\$1.00
#5039: 5K 5W 1" Shaft W.W. 4/\$1.00
#1001: 5K 2W 1" Shaft Carbon. 4/\$1.00
#1002: 2Meg 2W 3/4" Shaft Carbon. 3/\$1.00
#1003: 75 Ohms 3W 1/2" Shaft W.W. 4/\$1.00
#1004: 6K/6K 3W 1/2" Shaft Carbon. 4/\$1.00
50 Watts-25 Ohms, 40 Ohms, 50/50 Ohms, 300/300 Ohms, 400/400 Ohms, 10K Ohms; 1" Shaft. Your choice. ea. 75c
25 Watts-2 Ohms, 25 Ohms, 50 Ohms, 225 Ohms, 500 Ohms, 500 Ohms, 3000 Ohms, 5000 Ohms, 20K Ohms; W.W. Your choice. ea. 50c
The above are only a few representative samples of the many THOUSANDS we have in stock. Let us quote you on your requirements.

AIR COOLED TRANS. (NEW)

Pennsylvania 10 KVA: Two insulated windings. 220/110 Volts. A remarkable value at \$65.00
Westinghouse. 460/230-230/115 Volts, 1 1/2 KVA, Type JR. \$21.90
General Electric. 1 KVA: 60 cycle, 460/230-230/115 Volt. Cat. No. 61G29. \$19.00
Westinghouse. 460/230-230/115 Volts, 1 KVA, Type JR. \$17.00

Outdoor Distribu OIL FILLED

General Electric 3 KVA; Type 115; 3000/5200Y - 115/230. Style 3266596-GI

In original Factory Cases \$36

Westinghouse Type CSP 2400/4160Y Volts to 120/240

1 1/2 KVA \$100

3 KVA \$50

1 1/2 KVA \$37.50



400 CYCLE TRANSFORMERS

TRI024: Pri: 115V 400 Cy. Sec: 700V 120MA: 2.5V 3.0A; 2.5V 3.0A; 6.3V 2.25A; 6.3V 2.25A. \$1.00
TRI016: G.E. Pri: 115V 400 Cy. Sec: 800VCT 155MA; 5V 3.0A. \$1.00
TRI031: Pri: 115V 400 Cy. Sec: 700V 315MA: 200V 100MA; 6.3V 15A; 18V 600 MA; 5V 600 MA. \$2.00
TRI085: Kenyon Pri: 115V 400 Cy. Sec: 800 V 150MA; 200V 30MA; 5V 3.0A; 6.3V 7.5A. \$1.00
TRI005: G.E. Pri: 115V 400 Cy. Sec: 790V 400MA; 5.18V 6.0A; 5.18V 6.0A; 5.18V 2.0A. \$1.00
100V 40MA. \$1.75c
TRI006: Pri: 115V 400 Cy. Sec: 900V 75MA: 100V 40 MA. \$1.75c
TRI042: Pri: 115V 400 Cy. Sec: 1100V 500MA; 2.5V 2.2A; 6.3V 2.0A; 5V 9.0A. \$1.65
TR1048: Pri: 115V 400 Cy. Sec: 4250V 7.5MA: 2.5V 1.75A. \$2.00
FR1027: Pri: 115V 400 Cy. Sec: 6.3V 600MA; 2.5V 1.75A. \$1.75c
TRI028: G.E. Pri: 115V 400 Cy. Sec: 787V 39MA; 374V 46MA; 730V 170MA; 6.3V 600MA; 6.3V 300MA; 6.3V 150MA; 6.3V 5.5A. \$1.00
TRI021: G.E. Pri: 115V 400 Cy. Sec: 6.3V 7.0A; 6.7V 900MA; 6.3V 300MA. \$1.00

RESISTORS

3 Ohms Dual 150 Watts Bracket. \$60c
.45 Ohms Dual 150 Watts Bracket. \$60c
4 Ohms 150 Watts "Hibflex" Ferrule. \$60c
20 Ohms 30 Watts Bracket. \$1.4c
100 Ohms 50 Watts Bracket. \$1.6c
250 Ohms 90 Watts Bracket. \$1.45c
1000 Ohms 40 Watts Flat Type. \$1.6c
5000 Ohms 40 Watts Bracket. \$1.6c
300 Ohms 50 Watts Bracket. \$1.7c
250 Ohms 50 Watts Bracket. "Non Inductive". \$1.7c
1200 Ohms Lamp Adapter (#S46353A). \$50c
Multi Tap 1600 Ohms/2000/100/100 Flat Type. \$1.4c
Multi Tap 1600/2000/3600/2700 Flat Type. \$1.4c
2000 Ohms 34 Watts Bracket. \$1.6c
5000 Ohms 10 Watts Bracket. \$1.7c
5000 Ohms 5 Watts Ferrule. \$1.7c
12,000 Ohms 16 Watts Bracket Type EN. \$1.1c
14,000 Ohms 120 Watts Ferrule. \$1.60c
50,000 Ohms 50 Watts Bracket. \$1.8c
3 Mens 40 Watts Ferrule. \$1.60c
40 Mens 10,000 Volts Max Ferrule. \$1.75c
45 Ohms 25 Watts Bracket. \$1.1c
5 Ohms 5 Watts Bracket. \$1.7c
10 Ohms 25 Watts Bracket. \$1.8c

MINE DETECTOR SCR 625 Complete with tubes. Ideal for locating buried metal pipes, treasure, metallic fragments in lumber. Approx. depth of detection 6' depending on soil conditions. New \$65. Like New \$45.

CRYSTAL CONTROLLED MV SIGNAL GENERATOR, MM-144. Hickok. 15KC-30 MC. Crystal control at 100 KC and 1000 KC. Output Voltage Ranges RF 1/2 MV to 100,000 MV. Complete with instruction book. Like New \$45.

DELUXE STREAMLINED CABINET RACKS. Chrome decorated, hinged door on top w/ catch and hinged door on back. Amateur or W.E. notched panels fit. Black cracked 28-3/4" high, 18" deep. Panel space 26-4/8". Like New. \$15. ea. 2/527.

RCA COAST GUARD TRANS. Receiver TRC-120. 2000-3500 KCS, 5W A3 Emission w/2 Vibrapack Power Supplies. Like New \$35.

All prices F.O.B. Boston. Orders accepted from rated concerns on open accounts. Net 30 days.

Write for 112 Page Catalog on company letterhead



Dept. E. 11. 110 Pearl Street, Boston 10, Mass.

CHECK THESE VALUES

OIL CAPACITORS

Standard brand oil-filled capacitors at prices far below present manufacturers' list.

Afd.	Volts D.C.	Price	Mfd.	Volts D.C.	Price
.02	5000	\$1.89	2	1500	1.90
.035	10000	3.95	2	2000	2.95
.05	600	.49	2	2500	3.40
1	600	.89	2	3000	3.90
1	3000	1.90	2	4000	4.95
.25	400	.39	2	5000	9.90
.25	600	.89	2.5-2.5-5	600	.49
.25	1000	1.10	4	600	.89
.5	600	.89	4	1000	1.49
.5	300	3.25	6	600	.89
2x.5	100	.39	8	600	1.79
1	600	.89	8	1000	2.25
1	1000	.89	8	1500	3.25
1	1500	1.90	10	600	1.10
1	3000	2.65	10	1000	1.90
2	600	.69	12	1000	2.80
2	1000	.79	30	400	9.00

STANDARD BRAND POWER RESISTORS

Durably manufactured to comply with the most rigid codes.

Ohms	Type	Tol.	Class	Coat	Price
5	AA	5%	A	C	\$0.07
5	AB	5%	B	A	.07
5	AA	5%	A	A	.07
5	DJ	5%	A	A	.18
5	DJ	10%	B	A	.18
10	AB	10%	B	A	.10
30	AB	5%	B	A	.15
40	AB	5%	B	A	.15
50	AB	10%	B	A	.10
50	AB	10%	C	A	.10
100	AB	10%	B	A	.10
100	DJ	5%	A	A	.18
100	DJ	10%	C	A	.18
125	DH	10%	A	A	.15
150	DG	5%	A	A	.18
150	AB	10%	B	A	.10
150	DG	5%	B	A	.15
200	AB	5%	A	A	.15
520	DG	5%	A	A	.18
1000	ES	5%	A	A	.24
1000	FD	5%	A	A	.24
2000	AB	10%	B	A	.10
2500	DJ	10%	B	A	.18
2500	DJ	10%	B	A	.18
2500	DG	5%	B	A	.18
2700	HE	10%	A	A	.49
2700	HE	18%	A	C	.49
3000	HA	5%	A	A	.49
3000	DG	10%	A	A	.15
4000	DJ	10%	B	A	.18
4000	DJ	5%	A	A	.18
4000	AB	5%	A	A	.15
5000	HA	5%	A	A	.49
5000	AB	10%	A	A	.10
6000	AB	10%	C	A	.10
8000	AB	10%	A	A	.10
9000	DK	10%	B	C	.15
10000	DG	5%	A	C	.18
18000	AB	5%	A	C	.15
20000	DG	10%	A	C	.15

Air Condensers. Cardwell dual-stator transmitting condenser Type M0180BD; 190 pfd. maximum per section; 15 pfd. minimum per section; one-half these values in series resonance circuits. A \$7.00 value! Only \$2.49

Caldwell fixed plug-in air condenser Type JD100-OS; 0.125 air gap; 100 pfd. capacity. Only \$1.19

SPAGHETTI

Fibre Glass Sleeving

in 36-inch lengths; #20; red, black, green, and tracer. Per 36-inch length .4c

Plastic Sleeving

¾" clear; in 200-foot and 300-foot rolls. Per foot .2c
 ¼" black; in 400-foot rolls. Per foot .3c
 ½" black; in 150-foot coils. Per foot .4c

Varnished Fabric Sleeving

In 36-inch lengths

Size	Per length
#18	.4c
#10	.9c
#5	.9c
#2	.19c
#2	.19c
5/16"	.11c
7/16"	.19c
1/2"	.19c

TUBES! TUBES! TUBES!

From ignitions thru photocells—from simple germanium crystal diodes to multi-element photocells—the RADIO SHACK carries all types at competitive prices. *Manufacturers: write or wire for our low prices on large quantities.

Type	Price	Type	Price
6AC7*	\$ 0.99	1B32	\$ 3.95
6AG5*	.99	2J49	30.00
6AG7*	1.06	2J55	35.00
6AK5*	1.39	2J61	38.00
6C4*	.29	3B24	1.50
6AK6*	.89	3B26/RKR73	
C5B	1.90		4.95
C6A	9.00	3C23	6.50
FG27A	12.50	3C24	.38
QK59	45.00	4J36	45.00
QK60	45.00	4J37	45.00
QK61	45.00	5J11	19.00
QK72	45.00	5J12	19.00
VR90*	.75	5J14	19.00
VR105*	.75	6C21	24.00
VR150*	.75	274B	1.25
VT127A	3.95	304TH	3.95
WL417	22.50	304TL	1.95
WL653	22.50	350A	3.95
ZP653	22.50	371B	2.50
ZP679	22.50	723/AB	7.50
1B22	3.95	724B	4.50
1P23	3.95	725A	29.50
1B24	3.95	813	7.95
1B27	3.95	866A	.98
		872A	1.75

Silver Mica Capacitors. This bag of 100 silver micas in at least ten values between 15 pfd. and 1000 pfd. is easily worth \$25.00. Our low price only \$2.49

Jensen 15-inch PM Speaker A15PM. Used, but in good condition, these speakers provide a terrific sock at frequencies up to 10,000 cycles. A punch value... \$19.00

Electric Cabling Twine. Manufactured by Ludlow Manufacturing and Sales Company of Boston; mildew resistant; packaged in wrapped one-half pound rolls in sizes No. 3, No. 4, No. 9, No. 11, and No. 12. Per roll .79c

Struthers-Dunn Type ADBT8 Relay; ten-ampere DPST contacts; 110-volt 60-cycle coil .29c

Super-sensitive SPDT Relay; one-ampere contacts; 11,300-ohm coil; contacts close at 700 microamperes and open at 600 microamperes .15c

Flexible Armored Shafting to fit aircraft or mobile radio control. 72-inch or 80-inch lengths .49c

Shielded Push-pull Audio Output Transformer originally designed for Super-Pro; matches two 6V6's to 500 ohms... 89c

Aircraft Communications Set. CAA-Certified RTA1B \$900.00

Co-ax Cables. Brand new 50-foot coils of RGSU complete with 831SP fittings securely fastened to each end... \$1.95

Co-ax Fittings. Always popular co-axial fittings are available in job lot prices at the Radio Shack. For example:

831R Receptacle	40c
831SP Straight Plug	45c
831AP Angle Plug	55c
83-76s Hood	10c

Durable Test Leads with red and black superflex safety wire directly connected to brilliantly colored plastic angle-tip plugs and 6-inch probes... 79c

Standard EB Unmarked Binding Post; 8/32 x ¾" threaded stud; locked top bakelite construction .7c

10-ampere Binding Post Adaptor converts a banana plug terminal to a binding post .9c

Porcelain Insulators. A smashing value on conical porcelain feed-thru insulators. 1½" diameter; lead plated ¾" bolts 5" long, with washers, lock washers, and six nuts .19c

The RADIO SHACK Corp.

CABLE ADDRESS: RADIOSHACK

167 WASHINGTON ST., BOSTON, MASS., U.S.A.

GRAIN OF WHEAT LAMPS



Mazda G.E. 323 3V.19 A



Mazda G.E. 328 6V.2 A

Used for illuminating meters, compass dials, airplane instruments, etc. Soldering iron removes lamp from base to use in models, doll houses, miniature trains, Xmas trees, etc.

Photographs 3 times actual size. Glass Bulb 1/8" x 3/4"

Either type \$1.50 doz. \$75.00 per M.

3 1/2" x 1 3/8"

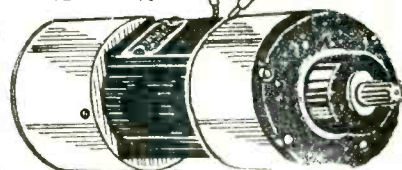

Operates on Flashlight batteries, speed depending on the voltage. Fairly strong on 6 volts, full power and speed on 27 volts. Designed to be used in bombsights, automatic pilots, etc., 250 RPM. FEW MORE AT \$5.00



HAYDON or TELECHRON SYNCHRONOUS MOTOR

to operate switches, etc., 1 Rev. per minute at this

SPECIAL PRICE \$3.85

Many other speeds available at \$5.25 up

EST. 1923

BLAN

EST. 1923

Experimenters and Inventors Supplies
64 Dey St., New York 7, N. Y.

BARGAIN BUYS

RADAR SETS: APR/1 with tuning unit, \$150.00—also available—3 cm types.

APS/3 and APS/4 complete.

TUNING UNITS:

TN/54 for APR/4—\$125.00 (New)

TUBES:

3BP-1	\$3.00	723A/B	\$5.00
3EP-1	3.50	725	15.00
531	2.50	728A	12.50
827R	\$60.00		

METER:

3"—0-150v DC (10 ma movement) \$2.50

Minimum order \$5.00; F.O.B. New York

Write for listings of other surplus bargains

LERU LABORATORIES, INC.

360 Bleecker St. New York 14, N. Y.

CORRECTION

• In the October Issue of ELECTRONICS the advertisement of the

POWERTRON
Electrical Equipment Co.
117 Lafayette St., N. Y. 13, N. Y.

(On page 290)

should have included the line:
 "Rebuilt . . . Thoroughly Re-Conditioned
 . . . Mechanically, Electrically Checked
 and Adjusted . . . Instruments Shipped
 Ready to Put into Actual Operation"

The foregoing was omitted
through our error.

Classified Advertising Division
ELECTRONICS

STANDARD POTENTIOMETER TYPE — MICROMAX

L & N INDICATORS — CONTROLLERS — RECORDERS

Rebuilt . . . Thoroughly re-conditioned . . . Mechanically, electrically checked and adjusted . . . Instruments shipped ready to put into actual use.

Model S—RECORDER—CONTROLLER



H.C.L. CONTACTS—115 V. AC Motor.

Ranges
0-1000° F C/A
0-1500° F C/A
0-1800° F C/A
200-2000° F C/A
1000-2000° F C/A

\$210.00



MODEL R RECORDER—CONTROLLER

H.C.L. Contacts — 115 V. AC motor.

RANGES

0- 800° F C/A
700-1400° F I/C
200-2000° C/A

\$175.00

Model S—RECORDER—CONTROLLER

Single Pen—2 Thermocouples—2 sets H.C.L. Contacts—115 V. AC motor. Ranges: 0-1200° F C/A, 0-1800° F C/A. **\$195.00**

Model S—RECORDER—CONTROLLER

Single Point—Chart tear-off feature —H.C.L. Contacts—115 V. AC Motor. Range 0-1500° F C/A. **\$195.00**



MODEL C—INDICATOR—CONTROLLER

H.C.L. Contacts—115V. AC Motor Ranges: 0-1500° F I/C, 0-1800° F C/A, 0-2000° C/A, 200-2000° F C/A.

Model C \$135.00

MODEL S—RECORDER

with alarm feature using relay & cam operated contacts. Can be used as on-off controller without temperature setting device. 115 V. AC motor. Range 0-1800° F C/A. **\$180.00**

MODEL S—2 PT. RECORDER

110 V. AC Motor Range 0-1800° F C/A (No Controlling Action) **\$235.00**

Model S—RECORDER—CONTROLLER

H.C.L. Contacts—115 V. AC motor Extra set on-off contacts. Range 0-1500° F C/A **\$195.00**

SURPLUS BARGAINS — — NOW!!

SELENIUM RECTIFIERS

New—Fresh Stock—Not over 6 mos. old. Full wave bridge . . . single phase . . . resistive inductive load . . . continuously rated . . . conservative design.

Type	Max. R.M.S. Input	Max. D.C. Output at 35° C	Price
5B-1	.24	18 V @ 3.1 A	\$5.03
5B-1	.24	18 V @ 5.2 A	6.73
10B-1	.24	18 V @ 10 A	8.71
1B-1	.24	19 V @ 1.6 A	4.04
16B-1	.24	19 V @ 16 A	16.40
24B-1	.24	19 V @ 24 A	23.76
1B-2	.48	37 V @ 1.2 A	7.21
3B-2	.48	37 V @ 3.1 A	9.60
5B-2	.48	37 V @ 5.2 A	13.37
10B-2	.48	37 V @ 10 A	17.18
16B-2	.48	37 V @ 16 A	30.89
24B-2	.48	37 V @ 24 A	44.67
5B-6	144	110 V @ 5.2 A	35.70
2B-6	144	112 V @ 2.4 A	21.86
1B-6	144	114 V @ 1.2 A	17.34
2B-7	168	131 V @ 2.4 A	25.51
1B-7	168	133 V @ 1.2 A	19.68
5B-7	168	133 V @ 5.2 A	41.10

RECTIFIER TRANSFORMERS

PRI—105/110/115/120 V.—50/60 Cycles—Open Frame Construction

SEC—	Rating	Weight	Price
18 V @ 2.5 Amps	4 lbs.	\$3.35	
18 V @ 5 Amps	5.5 lbs.	5.25	
18 V @ 10 Amps	10 lbs.	6.75	
18 V @ 25 Amps	25 lbs.	14.95	
18 V @ 50 Amps	30 lbs.	24.75	
36 V @ 2.5 Amps	7.5 lbs.	5.25	
36 V @ 5 Amps	10 lbs.	6.50	
36 V @ 10 Amps	20 lbs.	10.95	
36 V @ 25 Amps	30 lbs.	22.50	

PRI—115 Volts—50/60 Cycles

Open Frame Construction

SEC—	Rating	Weight	Price
135/145/155/165 V @ .5 Amps	5 lbs.	\$5.25	
135/145/155/165 V @ 1.5 Amps	15 lbs.	7.95	
135/145/155/165 V @ 2.5 Amps	25 lbs.	13.50	
135/145/155/165 V @ 5 Amps	35 lbs.	24.50	

HIGH VOLTAGE CAPACITORS

1 MFD 20 KV DC 18"x13 1/2"x5"	\$25.00
1 MFD 25 KV DC 13"x7"x4"	9.85
.001 MFD 50 KV DC 5 1/4"x7 1/2"x4" insulators 4" dia. x 7" high.	12.50

Cap. Mfd.	Volts D.C.	Height	Width	Length	Price
15	1000	5-7/8 x 1-3/4 x 3-7/8"			\$1.85
14	1000	5-7/8 x 2-3/4 x 1-1/4"			.85
1	1000	3-5/7 x 2" x 1-1/16"			.50
1	500	2" x 1-1/4" x 1-1/16"			.25
.25	1000	1-1/2 x 1" x 3/4"			.25

HEINEMAN CIRCUIT BREAKER

For use with low voltage, D.C., 100 Amps. Dimensions: 3 1/4" H x 4" D x 1" W. . . . \$1.75
15 Amp, 115 V AC, Curve 3, CAT.AM 2511-15 \$1.75
35 Amp, 120 V AC, Curve 2, CAT.AM 1510R-35 \$1.75
1.5 Amp, 117.5 V AC, Instant Trip. . . . \$1.75

WESTON Model 622—New!

D.C. Portables . . . 1/2 of 1% accuracy . . . High sensitivity . . . Moulded bakelite case . . . A famous instrument at a real low price.

Range	List Price	Your Price
0-20 Microamps—280 ohms	\$232.50	\$139.50
0-30 Microamps—1800 ohms	202.50	121.50
0-40 Microamps—150 ohms	217.50	130.50
0-10 Microamps—90 ohms	210.00	126.00
0-20 Microamps—45 ohms	210.00	126.00
0-100 Microamps—10 ohms	210.00	126.00
0-1/5/20/50/100 Millivolts	274.50	165.00
0-.5 Mills Thermal	300.00	180.00
0-.2 Mills Thermal	300.00	180.00
1.5/3/7.5/15/30/75 150/300/750 Volts	294.75	237.00

QUANTITIES LIMITED! ACT NOW!

WHSE PORTABLE GALVANOMETER



Type PX-12-7 M.A. movement, special scale, solid connecting terminals, contains a 1 volt internal cell which can be easily removed for conversion to DC AMMETERS & VOLTMETERS, with leather case & canvas carrying strap.

A buy at \$4.95

GE TYPE DO 50 DC AMMETER

50 MV FULL SCALE, RECTANGULAR 3 1/4" x 3" Barrel 2 3/4" DIAM, x 1 1/2" DEEP, MOUNTING HOLES 2 3/4" x 2 3/4" c. to c. SPECIAL SCALE, CAN BE USED WITH EXT. SHUNT FOR ANY RANGE, BAKELITE CASE

Price 10 for \$27.50

GE TYPE DO 50 DC VOLT METER

3 VOLTS FULL SCALE, 100 OHMS IV, SPECIAL SCALE, SAME DIMENSIONS AS ABOVE, BAKELITE CASE

Price 10 for \$27.50

MICROVOLTER—FERRIS Model 20B

.2 to 100,000 microvolts output, continuously variable . . . operates on 115 V. 60 cycle AC . . . push button selector for 18 frequencies from 455 K.C. to 22 M.C. . . with or without 400 cycle 30% modulation . . . frequency may be varied ±2% by screwdriver adjustment.

Your Price \$100.00

GE STEPDOWN TRANSFORMER

PRI 115/230 V 60 cycles. SEC 32 V. Rating .5 KVA Isolation type cat 61G60 enclosed, bell end, cont. duty.

Your Price \$7.50

STEPDOWN TRANSFORMER—SPECIAL

Made by GE . . . heavy duty . . . considerable over-design . . . open frame . . . ideal for rectifier application . . . size 3 1/2" x 3 1/2" x 4". Primary—115 V 60 cycles. SEC—15 V. @ 12 amps . . . a buy at . . . \$3.75 SEC—10 V. @ 18 amps . . . a buy at . . . 3.75

POWER TRANSFORMER

Pri.—440/220 V 60 Cy Sec—125/115/105 V. Rating .8 KVA RCA Open construction. Bracket mounted, pri & sec terminal board. Overall dimensions: 5 1/2" H. x 7 1/2" W. x 8" D. Mounting Dimensions 6 1/2" x 5 1/2".

Price \$12.50

TRANSTAT—3 K.V.A.



Type RH Input: 115 V. 10%. Output: 115 V. Max. Amps: 26 A. Made as a line voltage corrector 10% of input voltage, or can be connected to give plus 20% or minus 20% of input. Can also be reconnected to be used as an isolated type stepdown with variable secondary. Input: 115 V. Output: 0-30 Volts at 30 Amps. No Knob.

A Real Buy at \$18.00

(Same type but .25 KVA. Input: 103-126 V. Output: 115 V.-2.17 A.)

Price \$6.50

RHEOSTAT

Ohms	Amps	Size-Diam.	Price
.87	.13	3 1/2"	\$2.50
10	2	1 1/2"	1.75
10	0.2	1 1/2"	5.95
22	4.5-3.1	6"	6.50
30	1.7- .9	2 1/2"	1.50
32	2.4	3 1/2"	4.95
40	1.12	2"	2.50
50	1.11	2"	2.50
75	3.5	6"	7.50
100	1	3"	2.95
200	.25	1 1/2"	.75
250	2.5-.51	6"	7.50

STRUTHERS-DUNN RELAYS

D.P.S.T. Normally open, 115 V, 60 Cycle, AC coil, 30 Amp. contacts, fibre base with 4 holes for mounting. Dimensions, 4 1/2" L x 3" W x 3 3/8" H.

A Real Buy At \$2.50

ALL PRICES INDICATED ARE FOB OUR WAREHOUSE NYC. SHIPMENTS WILL BE MADE VIA RAILWAY EXPRESS UNLESS SUFFICIENT POSTAGE IS INCLUDED OR OTHER INSTRUCTIONS ISSUED. WE WILL REFUND EXCESS POSTAGE IN STAMPS.

POWERTRON Electrical Equipment Co.

117 LAFAYETTE STREET

Phone: WOrth 4-8610

NEW YORK 13, N. Y.

A LEEDS LEADER

- 50 microamp movement \pm 2%
- 2500 ohms DC Resistance \pm 2%
- Knife Edge Pointer
- 4x1/2 Black Bakelite Case
- Easily Read Multitester Scale



This is the exact meter utilized in the G.E. YMW-1A Lab Type Unimeter

A Great Special..... Each **\$9.75**
50 Microamp Scale 25c extra

RECTIFIER TRANSFORMER

DUAL PRIMARY
110 V AC Each

Secondary 0-35, 37 1/2 volt
0-70, 75 volt

This transformer is completely shielded.

Extra Special **\$1.95**

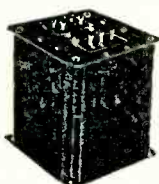

BIAS TRANSFORMER

Primary 115 V @ 0.5 Amp.
Secondary 6.3 V @ 1.2 Amps.
180 V @ .02 Amps.
5.1 V @ 7.0 Amps. C.T.
300 V @ .02 Amps.

This transformer is completely shielded and hermetically sealed. Brand New.

Special **\$1.95**

AMERTRAN TRANSTAT

Input: 230/115 V AC. Output: 103 to 126 volts at 8.5 amps. Rated at .88 KVA. Will make a perfect 230 to 115 volt step down transformer at about 880 watts.

A real buy at **\$9.95**

SUPERIOR POWERSTATS

Variable Transformer for precise Voltage Control. Excellent mechanical construction, design, and durability.

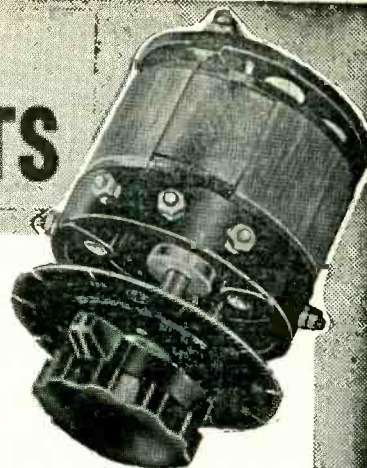

VARIABLE TRANSFORMERS

- TYPE 20: 115V. input, 0-135 V. output @ 3.0 amps. 0.4 KVA **\$12.50**
- TYPE 116: Mounted; 115V input, 0-135 V. output @ 7.5 amps. 1.0 KVA **23.00**
- TYPE 116U: Unmounted; 115V. input, 0-135 V. output @ 7.5 amps. 1.0 KVA **19.00**
- TYPE 1126: 115V. Input, 0-135 V. output @ 15.0 amps. 2.0 KVA **46.00**
- TYPE 1226: 230V. input, tapped at 115 V., 0-270 V. output @ 9.0 amps. 2.4 KVA **46.00**
- TYPE 1156: 115V. input, 0-135 V. output @ 45.0 amps. 6.1 KVA **118.00**

If not rated 25% with order, balance C.O.D. All prices F.O.B. our warehouse New York. We ship to any part of the globe. Write Dept. EL



The Home of RADIO
75 VESEY STREET
Ortlandt 7-2612 N. Y. C. 7

SURPLUS

LABORATORY EQUIPMENT

We have in stock, for immediate delivery, the following surplus Laboratory Instruments, fully tested and guaranteed.

General Radio: 107M Variable Inductors; 224A, 724A. Wavemeters; 821A Twin-T Bridge; 775A Frequency Limit Monitor; 620A Het. Freq. Meter; 805A Std. Signal Generator.

Ferris: 18B Signal Generator; 33A, 34A Crystal Calibrators; 16C Std. Signal Generator.

Boonton: 120A V.H.F. Circuit Checker; 140A Wide Range BFO; 155A FM Signal Generator.

Hewlett-Packard: P-6255B Interpolation Oscillator 510-1000 & 1280-2520 CPS.

L & N: 4223 Precision Resistor; 7655 Portable indicators and Standard Cell.

Millen: P4E Synchrosopes.
Western Electric: RA 90A High Voltage Power Supplies, +4900 V. -1000V DC. Input 110V, 400; TS/5AP Range Calibrator (Sweep Marker Generator); 15154, D 152213 Modulator Oil Units; TS9/APQ-5 Range Calibrator Modulator; 157A Output

Transformers; Breakdown Testers, 500 volt.

Weston: Model 1; 0-300 M.A.; 0-500 Volt D.C. Model 45; 0-75 Volt; 0-300 Volt; 0-1500 Volt; 0-150 M.A.; 0-300 M.A. D.C.; 785 Industrial Analyzer.

Dumont: 213 Modulation Monitor.

G.E.: LU Radar Test Equipment.

Distillation Products: Pirani Gauge.

Industrial Instruments: RN-1 Wheatstone Bridges; MB3 Megohm Bridge.

Shalleross: 621 Resistance Limit Bridge.

WRITE FOR COMPLETE PRICE LIST

All Equipment—F.O.B., New York City.

Subject: To prior sale

THE NATIONAL INSTRUMENT CO.

FAR ROCKAWAY, N. Y.

Cable Address: NATINSTRU, New York

SOLID SAVING SALE

CLARE 200 OHMS



24v SPST Normally open. No. R13. 15 amp contacts. Ship wt. 1 lb. 48c ea.
Clare 3500 ohms. SPST 6MA Plate circuit relay No. R30. **89c ea.**

1ST RF TRANS.

Ass'y MN26 & ARN-7 S1k#2C-3035-5/T7. Ship. wt. 3 1/2 lbs. \$1.95 ea.
ANT Trans Ass'y MN26 & ARN-7 S1k#3CK-1084C-24. Ship. wt. 3 1/2 lbs.



\$2.50 ea.

G. E. ANTENNA



Change-over relay. DPDT & SPST. N.C. 50 ohms, 12v DC, 10 amp contacts. No. 37843 R57. Ship. wt. 1 lb.

89c ea.

POWER TRANSFORMER

1500v C.T. at 150 ma, 6.3v 2.5a, 6.3v 1.6a, 5v 3a, 115v 50-60c pri G.E.



\$5.25 ea.

FILTER CHOKE



4 3/4 x 3 1/4 x 4 1/2 h. 9 lbs. W.E. 1000ma 1by 4 ohms. No. T46. Ship. wt. 21 lbs.

\$2.89 ea.

Hi-Voltage Oil Filled Capacitor

0.2 mf 500 wydc. Std. makes with Mtg. Brackets, \$1.89 ea.

Sigma Sensitive Relay-Type 4AH, SPDT, 2,000 ohms, 4 ma in, 1.5 ma hold. Sealed unit. 5 prong plug in base. **99c ea.**

MIN. ORDER \$2.50. PRICES NET F. O. B. OUR PLANT

The "KELLOGG DEHYDRATOR"

An all purpose self-reactivating dehydrating unit. To be used for removing moisture from gases. Numerous applications in the fields of Physics, Electronics and Chemistry. Dual insulated tanks with thermostatically controlled heating elements. Complete with 20 lbs. of Silica gel, heating elements, shut-off and safety valves. **\$62.50**

F.O.B., N. Y.

INTERSTATE Appliance Co., Inc.

Dept. KD, 600 Broadway, NEW YORK 12, N. Y.

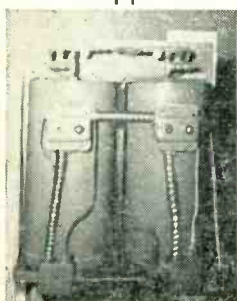

Universal general corp.
365 CANAL ST N.Y. 13 WA 5-9642

BEST SURPLUS BUYS

RECTANGULAR OIL CONDENSERS

1 mfd 600vdc... .25	2 mfd 5000vdc. 4.95
2 mfd 600vdc... .30	4 mfd 5000vdc. 6.50
3.5 mfd 600vdc... .49	1 mfd 7500vdc. 9.95
4 mfd 600vdc... .45	.1 mfd 15,000vdc. 8.95
5 mfd 600 vdc... .49	
10 mfd 600vdc... .85	2 X.005 mfd 4000 vdc. 1.95
2 mfd 1000vdc... .65	2.1 mfd 7000vdc. 1.95
4 mfd 1000vdc... .95	.15 mfd X 8000vdc; .15v X 5000vdc. 1.95
4 mfd 1500vdc. 1.95	.25 mfd 20,000vdc. 19.95
1 mfd 2000vdc... .85	
2 mfd 2000vdc. 1.50	
6 mfd 2000vdc. 4.50	
2 mfd 3000vdc. 2.65	
4 mfd 3000vdc. 4.50	

.0001 X 20,000VDC MICA SANGAMO G3	\$19.95
GR STANDARD CONDENSER TYPE 509M	
0.02 mfd	3.95

LOWEST TUBE PRICES

2C26A .49	RKR73 \$2.95	841 .59
7C4 .75	VR-150 .75	864 .59
10Y .49	801A .79	1625 .39
12A6 .29	814 3.95	24G .39
15R .98	826 .59	957 .43

TUBE SOCKETS

Acorn, Ceramic	.18
Octal, Mica Filled, Ring Mounting, Amphenol	.06
Octal, Ceramic, Ring Mounting	.12
Johnson #247 for 826,829 etc.	.25
Johnson 210 4 Pin Med. Bayonet	.29
4 Prong Ceramic for 705, 715B etc.	.65
Millen Plate Cap 3600L F/866 etc.	.18

FUSES - HOLDERS - LAMPS

4AG, 3A 250V Little Fuse \$2.50 Ct, \$22.00M Renewable 2" X 19/16" GE 30A 250V...	.20ea.
Fuse Holder Little Fuse (341001).....	.10ea
Mazda #323-3V Grain of Wheat.....	.10ea

TRANSFORMER - CHOKES

Amertran Filament Transformer 2.5V Ct @ 20A; -115V., 50/60 CPS PRI; HV. INS.	\$5.95
Filter Choke 15H @ 150MA Sealed.....	1.25
Filter Choke 15H @ 100MA Sealed.....	.89
UTC 41866 Standard AC-DC Choke 65MA Strap Mounting.....	.49

IF TRANSFORMER

ALLADIN GA101 & GA102, Polyrion core; Air Tuned; Excellent Quality receiver, Replacements—Input & Output IF; 465 KCS. PAIR..... \$1.00

COAX. CABLE

RG 7U.....	\$35M	RG 29U.....	\$35M
RG 8U.....	\$37.50M	RG 58U.....	\$59M
RG 11U.....	\$100M		

DYNAMOTOR SUPPLY, for Mark II, Input, 12V @ 9.4A, Output, 275 @ .110 and 500V @ .050A \$4.95
 DYNAMOTOR SUPPLY, for SCR-522 (PE 94) 28V Used Perfect..... \$2.95

ALTIMETER RECEIVER

RT7/APN1, Complete with 14 tubes, and dynamotor, Specially Priced..... \$7.95

All Material Fully Guaranteed, Minimum order \$2.00 Unrated Accounts 25% with order. All equipment new Surplus, unless otherwise indicated. All prices FOB, N. Y. C.

STANDARD RADIO-ELECTRICAL PRODUCTS

2260 Washington Avenue
 New York 57, New York

SELENIUM RECTIFIERS

AND SPECIALIZED ELECTRONIC COMPONENTS

THIS MONTH'S SPECIALS !!

VACUUM CAPACITOR



50 MMFD.
 20 KV.

\$495

OIL CAPACITOR

.125 MFD.
 27 KV.DC.

\$1750

With mounting brackets

TRANSFORMER

HIGH CURRENT
 AMERTRAN



5.1 Volts at 190 Amps.
 Primary 105/125 Volts

Can easily deliver 250 Amps. Insulation 35 Kv. Test. Approx. Shipping weight 75 lbs.

\$1750

Full Wave Bridge Types

Input	Output	
0-18VAC	0-13VDC	
Type#	Current	Price
B1-250	250 MA.	\$ 3.98
B1-600	500 MA.	1.95
B1-1	1 AMP.	2.49
B1-1X5	1.5 AMP.	2.95
B1-3	3 AMP.	3.49
B1-5	5 AMP.	5.95
B1-7X5	7.5 AMP.	7.95
B1-10	10 AMP.	9.95
B1-15	15 AMP.	13.95
B1-20	20 AMP.	15.95
B1-25	25 AMP.	20.95
B1-30	30 AMP.	24.95
B1-40	40 AMP.	27.95
B1-50	50 AMP.	32.95
B1-60	60 AMP.	36.95

Full Wave Bridge Types

Input	Output	
0-54VAC	0-40VDC	
Type#	Current	Price
B3-150	150 MA.	\$1.25
B3-250	250 MA.	1.95
B3-600	600 MA.	3.25
Input	Output	
0-72VAC	0-54VDC	
Type#	Current	Price
B4-1X2	1.2 AMP.	\$7.95
B4-3X5	3.5 AMP.	15.95
B4-5	5 AMP.	17.95

Full Wave Bridge Types

Input	Output	
0-36VAC	0-25VDC	
Type#	Current	Price
B2-150	150 MA.	\$.98
B2-220	220 MA.	1.25
B2-300	300 MA.	1.50
B2-450	450 MA.	2.25
B2-600	600 MA.	2.95
B2-1	1 AMP.	3.95
B2-2	2 AMP.	4.95
B2-3	3 AMP.	6.95
B2-5	5 AMP.	9.95
B2-6	6 AMP.	10.95
B2-7X5	7.5 AMP.	13.95
B2-10	10 AMP.	15.95
B2-15	15 AMP.	24.95
B2-20	20 AMP.	27.95
B2-30	30 AMP.	36.95

Three Phase Bridge Types

Input	Output	
0-126VAC	0-130VDC	
Type#	Current	Price
3B7-4	4 AMP.	\$32.95
3B7-6	6 AMP.	48.90
3B7-11	11 AMP.	65.00

Full Wave Bridge Types

Input	Output	
0-115VAC	0-110VDC	
Type#	Current	Price
B6-150	150 MA.	\$1.95
B6-250	250 MA.	2.95
B6-400	400 MA.	4.95
B6-600	600 MA.	5.95
B6-800	800 MA.	7.95
B6-1X2	1.2 AMP.	9.95
B6-2	2 AMP.	12.95
B6-3X5	3.5 AMP.	21.95
B6-5	5 AMP.	24.95
B6-7X5	7.5 AMP.	32.95
B6-10	10 AMP.	36.95

CENTER TAPPED TYPES

Input	Output	
12-0-12VAC	0-8VDC	
Type#	Current	Price
C1-10	10 AMP.	\$7.95
C1-20	20 AMP.	12.95
C1-30	30 AMP.	17.95
C1-40	40 AMP.	21.95
C1-50	50 AMP.	25.95
C1-80	80 AMP.	34.95
C1-120	120 AMP.	46.95

* Select Proper Capacitor From List Shown Below, to Obtain Higher D.C. Voltages Than Indicated

RECTIFIER MOUNTING BRACKETS

For Types B1 through B6, and Type C1.....	\$.35 per set
For Types B13.....	.80 per set
For Types B3.....	1.20 per set

RECTIFIER CAPACITORS

CF-13	6000 MFD	10VDC	\$2.49
CF-14	3000 MFD	12VDC	1.69
CF-15	6000 MFD	12VDC	2.95
CF-1	1000 MFD	15VDC	.98
CF-2	2000 MFD	15VDC	1.69
CF-3	1000 MFD	25VDC	1.69
CF-4	2X3500 MFD	25VDC	3.49
CF-18	10000 MFD	25VDC	4.95
CF-5	1500 MFD	30VDC	2.45
CF-6	4000 MFD	30VDC	3.25
CF-7	3000 MFD	35VDC	3.25
CF-8	100 MFD	50VDC	.98
CF-16	2000 MFD	50VDC	3.25
CF-17	50 MFD	150VDC	.59
CF-9	200 MFD	150VDC	1.69
CF-10	500 MFD	150VDC	3.25
CF-11	100 MFD	350VDC	2.25
CF-12	125 MFD	350VDC	2.49

Rectifier Transformers

All Primaries 115VAC 50/60 Cycles

Type#	Volts	Amps.	Price
NF15-12	15	12	\$3.95
TXF36-2	36	2	3.95
TXF36-5	36	5	4.95
TXF36-10	36	10	7.95
TXF36-15	36	15	11.95
TXF36-20	36	20	17.95

RECTIFIER CHOKES

Type	Amps.	Price
HY2 .03 Hy	2	\$2.25
HY3 .03 Hy	3	2.95
HY5 .02 Hy	5	3.25
HY8X5 .02 Hy	8.5	7.95
HY10 .02 Hy	10	9.95
HY12 .125Hy	12	12.95
HY15 .015Hy	15	13.95

All TXF Types are Tapped to Deliver 32, 34, 36 Volt.

ELECTROLYTIC CAPACITORS

	50 VDC	100 VDC	250 VDC	450 VDC	500 VDC
100 MFD	\$2.20	\$19.00			
50 MFD	2.00	18.50			
8-8-20 MFD	350.150 VDC	4.70	43.00		
*20-20 MFD	400.250 VDC	4.50	38.00		
10 MFD	450 VDC	2.50	20.00		
15 MFD	450 VDC	2.50	20.00		
15-15 MFD	450 VDC	3.00	22.00		
40 MFD	450 VDC	4.20	36.00		

* 4 prong plug-in type.

METERS

O-15 MA D.C. Weston #506 2" Rd.	\$2.95
O-30 A.D.C. Weston w/shunt 2 1/2" Rd., aircraft type.	2.95
O-50 A.D.C. Weston #301 3 1/2" Rd., Enclosed shunt	5.50
O-60 A.D.C. West., w. shunt, 2 1/2" Rd., aircraft type.	3.25
O-120 A.D.C. West., w. shunt, 2 1/2" Rd., aircraft type.	4.95
O-8 V.A.C. G.E. 3 1/2" Round.	2.95
O-30 V.D.C. West. 2 1/2" Rd., aircraft type	2.95

To avoid shipping errors, kindly order by type #. All prices subject to change without notice.

ATTENTION ! ! !
 INDUSTRIALS, EXPORTERS, SCHOOLS
 GOVT AGENCIES, LABORATORIES
 Our engineering staff is at your service to facilitate the application of rectifiers for your specific requirements.
 Write for quantity discount on company letterhead.

Minimum order \$3.00. No C.O.D.'s under \$25.00. 25% deposit on C.O.D. Add 10% for Parcel Post and handling. Terms: Net 10 days to rated concerns only.
 Orders Promptly Filled From Our Stocks

OPAD-GREEN COMPANY

71 Warren St. Phone: BEekman 3-7385 New York 7, N. Y.

AIRCRAFT RADIOS — STOCK DELIVERY

Static Discharge Wicks AN/ASA-3
Brand new approved type wick at unprecedented low price
price **.89c ea.**
BOX OF 200 \$150.00

GLIDE PATH SET

AN/ARN-5A companion to localizer equipment. 100% complete including all plugs, shockmount. Brand New **\$25.00**

Localizer—Extra Special!!

Instrument landing localizer set RC-103. 100% complete, including antenna (not shown). This equipment is sold with the type-certificable receiver RC-733-D and all cables, including RG-22/U, are completely fabricated. Save over \$50.00 on installation. (24V). **\$49.50**
(12V additional \$7.00)
R8911/ARN-5 Glide Path..... **\$60.00**

Flexible Shafting MC-215

For 274-N, ARC-5, RL-42, 53" lengths..... **\$1.25 ea.**
154" lengths..... **\$1.85 ea.**

FL-8 Range Voice Filters \$1.95 ea

PLUGS

ANY "AN" Type Connector - 50% of list. 20 or more 60%. Order by "AN" number or general description.
274-N or ARC-5 Plugs: PL-147, 148, 151, 152, 153, 154, 156 **\$.50**
PLUGS for Radio Compass: PL-108 75c each, PL-112, \$1.00 each, PL-118, \$1.00, PL-122, \$1.50

RADIOS

MN-26-C or Y 100% complete, brand new 24-V **\$125.00 set**
(12 volt MN-26 available at \$15.00 additional)
ADF SCR-269-G 100% complete brand new **\$295.00 set**
ADF AN/ARN-7 100% complete brand new **\$295.00 set**
SCR-183 Transmitter-Receiver, complete with plugs **\$37.00 set**
Ammeter AN/APN-1, 100% complete, brand new **\$39.00 set**
Bendix Receiver RA-10-DB, 100% complete, brand new **\$70.00 set**
AN/ARC-3 VHF Transceiver 100% complete, less crystals, including mounts, plugs, dynamotors, etc. Brand New **\$450.00**
Marker Beacon Rec. 100% complete incl. mount, plugs, prefab, antenna and indicator 24-V. **\$24.50**
12V..... **\$17.50 set**

Bendix VHF Field Strength Meter I-95 Brand New

A must for every radio repair shop & VHF operator. Range 100-156 MC. Checks frequency field strength & radiation pattern. **\$24.50 ea.**

RL-42 Antenna Reels \$4.50

DYNAMOTORS

PE-86 w/filter 24 V. in 250 @ .80 ma out \$ 3.75 ea.
DM-53-A (BC-733) 24 V. in..... 5.00 ea.
DM-28 w/filter (BC-348) 24 V. in..... 5.75 ea.
BD-83 w/filter (SCR-183) 12 V. in..... 10.00 ea.
PE-73 w/filter (BC-375) 24 V. in..... 20.00 ea.
BD-77 w/filter (BC-191) 12 V. in..... 7.00 ea.
PE-109 12 V. inverter..... 50.00 ea.
MG-149-F 24 V. inverter..... 25.00 ea.
MG-149-II inverter..... **\$35.00**
DY-21/ARC-3..... **\$10.00**
DY-22/ARC-3..... **\$4.00**

BRUSH SETS

DM-24 (BC-224) 2 ea. LV & HV..... \$ 75 set
DM-28 (BC-348) 2 ea. LV & HV..... 75 set
DM-32 (274-N Rec.) 2 ea. LV & HV..... 35 set
DM-33 (274-N Mod.) 2 ea. LV & HV..... 45 set
PE-109 (12-V compass) 2 LV only..... 60 set
BD-77 or PE-73 2 LV 2 HV..... 95 set
Compass: Band-change Motor..... 45 set
Compass AUTOSYN..... 35 set
PE-94 or PE-98 (SCR-522) set of 6 ea..... 95 set

CONTROL BOXES GALORE

MN-28-C Y or LB or BG-434-A..... \$10.00 ea.
Loop Control Box MN-52..... 3.50 ea.
BC-602 for SCR-522..... 2.50 ea.
BC-732 for BC-733..... 2.50 ea.
BC-450 for SCR-274-N Rec..... 2.50 ea.
BC-451 for SCR-274-N Xmitter..... 2.00 ea.
BC-1366 Jack Box..... .95 ea.
Ant. Reel Control Box BC-461..... .95 ea.
Bendix Jack Box MI-22..... 2.50 ea.
Change-Over Relay BK-22-K..... 4.50 ea.
Compass Relay SW-182 (12V)..... 3.95 ea.
Antenna Relay BC-442..... 2.50 ea.

ALL MATERIAL BRAND NEW GUARANTEED

"Our Reputation Is Your Protection"
ASK ANY CERTIFICATED AIRLINE
TERMS: If not rated, 25% with order, balance C.O.D.

300 New Surplus Relays or Contactors

All in original manufacturers cartons

- 110 volt, 60 cycle
- Cutler Hammer Type 619 un-mounted contactors
- 4 pole, 25 amp., 600 volt normally open contactors
- Some have pilot contacts.

L. R. RUOFF

94-18 51 Ave. Elmhurst, N. Y.

We have one of the largest stocks in the country of AN-UG and UHF and BRITISH TYPE CONNECTORS

Write us your requirements

Attention: **INDUSTRIALS • LABS
SCHOOLS • AMATEURS**

Let us quote on components and equipment that you require. We have too many items to be listed here. Place your name on our mailing list now for news of exceptional buys!

Write for FREE CATALOG

ACORN ELECTRONICS CORPORATION

80 Vesey St. Dept. E-11 New York 7, N. Y.

An Investment !

Productive advertising is an INVESTMENT rather than an EXPENDITURE.

"Searchlight" advertisers almost invariably report prompt and satisfactory results.

BE CONVINCED— send us your advertisement TODAY.

Address

Classified Advertising Division

ELECTRONICS

330 W. 42nd St., N. Y. 18. N. Y.

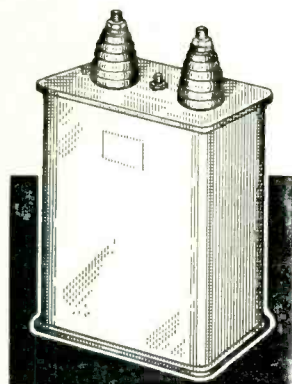

15,000 V. Working 1 mfd. Capacitor

Nationally Known Brand, Oil-Filled

Priced at a fraction of original cost, these husky capacitors have hundreds of applications—in communications, —in industry, as capacitor-discharge spot welders and power-factor correctors,—in the research laboratory.

Only 1200 available,—Act Now!

\$15.00 EACH

NEW—SURPLUS
Individually packed for overseas shipment.

WIRE—WRITE or PHONE
(Market 1-4568)

SAN FRANCISCO RADIO & SUPPLY CO.
1284 Market St. San Francisco 2, Calif.

BOONTON

140-A BEAT FREQUENCY GENERATOR

Range 20 CPS to 5 MC. Output Voltage 1 MV to 32 Volts. We have one unit for immediate delivery.

RECONDITIONED GUARANTEED
THE NATIONAL INSTRUMENT CO.
FAR ROCKAWAY NEW YORK

ELECTRONIC TUBE-MAKING MACHINERY

For manufacturing radio tubes, electronic tubes, cathode-ray tubes, lamps. New and used. Reasonably priced, satisfaction guaranteed.

AMERICAN ELECTRICAL SALES CO.
67 E. 8th St. New York, N. Y.

LOW OVERHEAD-

THAT'S WHY YOU
SAVE at SENCO!



OIL FILLED CONDENSERS

Standard Brand Upright Type.
Stand-Off Insulators

4 Mfd. 600 VDC	\$.45
6 Mfd. 600 VDC	.69
7 Mfd. 600 VDC	.74
8 Mfd. 600 VDC	.79
10 Mfd. 600 VDC	.89
8 Mfd. 1000 VDC	1.90



MICROPHONE CABLE

A B C D E F G H

A—18 Strands Silver-Plated Tinsel. B—Double Serving Cellulose Acetate. C—Yarn with Moisture Proof Treatment. D—Black Braid. E—Salt and Pepper Braid. F—Braid of Tinned Copper. G—4 Strands #36 Braid of Cotton Cover. H—1/16 Rubber Jacket. Black 60% Rubber Compound.
only 4c per foot

POWER TRANSFORMERS



All Fully Shielded, Flush Mount
5V @ 2 amps 580V C.T. \$1.79
100 mil—6.3V @ 3 amps
5V @ 2 amps 750V C.T. 2.95
150 mil—6.3V @ 4 amps
5V @ 3 amps 750V C.T. 3.39
200 mil—6.3V @ 3.3 amps
5V @ 3 amps 815V C.T. 4.45

SPEAKER Specials

Top quality, precision-built speakers at absolute minimum cost. Stock up now!

3" P.M.—68 oz. Alnico V	\$ 1.15
3" P.M.—1.47 oz. Alnico V	.99
3" P.M.—1 oz. Alnico V	.89
4" x 6" P.M. Speaker	1.15
4" P.M.—1 oz. Alnico V	1.15
5" P.M.—1.47 oz. Alnico V	1.55
5" P.M.—2.15 oz. Alnico V	2.75
6" P.M.—2.15 oz. Alnico V	3.69
8" P.M.—6.8 oz. Alnico V	4.39
8" P.M.—6.8 oz. Alnico V	4.95
10" P.M.—3.2 oz. Alnico V	5.95
12" P.M.—6.8 oz. Alnico V	
12" P.M.—21 oz. Alnico V	\$7.95 compl.
8" Dynamic 680 ohms field with 6V6 P.P. Output	3.95 compl.
12" Dynamic 680 ohms field with 6V6 P.P. Output	6.95 compl.
12" Dynamic 1000 ohms field	5.95

VOLUME CONTROL Bargains



Nationally advertised brand. An exceptional value! All brand new. Take advantage of this saving now!

10,000 ohms V.C., 3" shaft	
25,000 ohms V.C., 3" shaft	
50,000 ohms V.C., 3" shaft	
100,000 ohms V.C., 3" shaft	
250,000 ohms V.C., 3" shaft	
500,000 ohms V.C., 3" shaft—Tapped	
1 meg ohms V.C., 3" shaft—Tapped	
2 meg ohms V.C., 3" shaft—Tapped	

only 44c ea.

IF TRANSFORMERS



Medium Size 456 KC IF Transformer—Input & Output 32c
Medium Size 456 KC IF Transformer with AVC Tap 39c
Midsize 456 KC IF Transformer—Input & Output 49c

MINIMUM ORDER \$1.00

WHEN ORDERING—Send 25% deposit for all C.O.D. Shipments. Include sufficient postage — excess will be refunded. Orders without postage will be shipped express collect. All prices F.O.B., New York City.

SENCO RADIO INC.

Dept. 5, 71 West Broadway
New York 7, N. Y. BECKMAN 3-6498

BUY COMET

OUTSTANDING VALUES!

PIONEER #2K20 ROTARY CONVERTER

Input: 230VDC, 1.5 amperes.
Output: 110VAC, 60 cycle—200 volt amperes.
1.82 amperes Power factor 0.9 Sleeve bearing type. 3600 RPM.
Dimension: 11 1/2" x 6" x 8 3/4". Includes—filter unit to suppress high frequency currents —5 foot cord with male and female plugs—Manual—spare brushes. New.....\$49.95

LS-3 SPEAKERS

Navy type. In waterproof metal case. Jensen six inch PM Speaker. \$7.95
New.....
Army type. Enclosed in metal case. Six inch Jensen PM Speaker. Used.....\$4.95
Good condition.....

A NATURAL!!!



TOM THUMB CAMERA RADIO

- The Ideal Companion for Outdoor Activities
 - A Year Around Must
 - Precision Built — Beautifully Designed
 - Excellent Tone Quality
 - Portable Batt. Operated Radio
 - Reflex Type Camera
 - 16 Pictures Less Batteries on Standard #127 Film
- \$26.57**
Dealer Price

SENSATIONAL! RECHARGE YOUR AUTO BATTERY with the NEW AUTOMATIC AUTO RADIO



Dealer Price **\$34.97**
with BUILT-IN BATTERY CHARGER

- Patent pending
 - Sensational Features *
 - Powerful 6 Tube Radio
 - 3 Gang Condenser
 - Extra R.F. Stages
 - For Increased Sensitivity
 - Large P.M. Speaker
 - Single Compact Unit
 - Easily Installed
- BATTERY CHARGER**
- Charges Through Radio
 - Simply plug Radio Cord into 110 v. A.C. Electric Outlet
 - Makes Winter Starting Sure

JUST ARRIVED! RS/ARN-7

RADIO COMPASS RECEIVER
Airborne 15 tube Superhet receiver. Capable of C W tone, and voice reception over frequency range of 100—175 Kc. Operates from 115V, 400 cycle AC. Can be easily converted to home use. New.....**\$44.50**
Used. Excellent condition.....**\$32.95**

SPECIAL!!



FAMOUS TOM THUMB PORTABLE RADIO ATTP

- Recharges Its own Dry Batteries
 - Operates on Battery—A.C.—D.C.
 - Four Tube Superheterodyne
- Battery—A.C.—Less Batteries **\$25.95**
Dealer Price

SPECIALS

- Sound Powered Chest Set—Headset and Mike.....\$18.95
- 6 Henry Swinging Choke 7-5 HY 90MA 2000 HM.....\$2.25
- DC Voltmeter 1-23 0-10 Volt 0-35 Amps, 2 1/2 Dia. Pocket Type in Leather Case. Battery Testing \$1.20
- HS-33 Headset 600 Ohm Cord and P1 354.....\$2.39
- 2 J33 Magnatron.....\$15.00
- 700B Magnatron.....\$35.00

RELAYS

- 6VDC, DPDT, Antenna. Coll 15-190 HMs.....\$0.40
- 6VDC, DPDT, contacts, 6 S. coll. 33 ohm, nur. open.....\$0.45
- 24VDC, 5A, DPDT, Allied #BJ6D36.....\$0.40
- 24 VDC, 50A, SPST, current, Leach.....\$1.49
- 110VAC, DPST, contacts Struthers Dunn CXA1970, 230 VDC, 1 Amp.....\$1.95
- 110VAC, DPDT, RF antenna, change-over.....\$3.50
- 110VAC, Mercury time delay, 30-40 sec. release 3 sec.....\$12.95
- 115VAC, DPST, contacts Struthers Dunn 84BXX103, 115VAC, 30 Amp.....\$2.45
- 115VAC, Time delay, 1 minute enclosed in waterproof metal box.....\$3.95
- 120VAC contacts: 48V 30A, AC 20A, DC 115V 30A, AC 20A, DC 230V 15A, AC 3A, DC enclosed in metal case, hinged front.....\$4.50

CIRCUIT BREAKERS

- 24VDC, .220 AMP, Heinemann.....\$0.49
- 115V, 30 AMP, Heinemann.....\$2.25
- 125V, 20 AMP, Westinghouse.....\$1.95

FILAMENT TRANSFORMERS

- 115V—0.12A, 60 cycle output 6.60 @ .6A 2000V Ins. 2.6V @ 1.75A 2700V Ins.....\$2.95
- 115V—0.7A 60 cycle output 6.4V @ .40A, 6.3V @ .6A Step-Down Transformer.....\$3.25
- 440V—60 cycle secondary 115V .0575 KVA.....\$2.25

POWER EQUIPMENT

- Inverter PE 151 12VDC output 110 VAC 150 W new.....\$10.95
- Vibrapak V1G 369 12VDC 250V @ 70 M A synchronous, output Malory, new.....\$3.45
- Voltage Regulator Raytheon 95/130V 1.25 AMPS 60 cycle output 115V 60 Watt, new.....\$9.50

CAPACITORS

- Xmitter Mica
- .1MFD, 1000VDC.....\$0.30
- .70MFD, 1140VDC......85
- .003MFD, 2000VDC......35
- .002MFD, 2500VDC......45
- .005MFD, 3000VDC......60
- .000375, 5000VDC.....1.10
- .0012MFD, 20,000VDC.....23.95

COAXIAL CABLE

- Minimum Order 1000 Feet
- RG5U.....\$43.50/M
- RG11.....\$58.00/M
- RG8U.....\$40.00/M
- RG22.....\$85.00/M

POTENTIOMETERS (STANDARD BRANDS)

Cat. No.	Type	Ohms	Watt	Taper	Bush	Shaft	Price Each	Ten
.082B2	W W	3,000	2	L	1/2"	1"	\$0.25	\$2.20
136B1	W W	5,000	2	L	1/2"	5/8"sl	.25	.20
.063	W W	20,000	3	L	3/8"	1 1/16"sl	25	20
.187B1	W W	3,000	4	L	3/8"	1 3/32"sl	27	22
N2107	W W	100	25	L	3/8"	1/2"	55	50
155B1	W W	15,000	25	L	1/2"	1"	69	55
105	W W	20,000	25	L	1/2"	1"	69	55
100B1	Carbon	200/200	2	L	1/2"	1"	28	25
.123B1	C	5,000	2	L	1/4"	3/4"	22	19
.108B2	C	5,000	2	L	1/2"	7/8"	22	17
N52	C	25,000	2	L	3/8"	1 3/4"	25	20
.120B1	C	25,000	2	L	1/2"	5/8"	25	20
.122B3	C	50,000	2	L	3/8"	7/8"	25	20
.125B1	C	50,000	2	L	1/4"	3/4"	25	20
N139	C	1MEG	2	L	3/8"	5/16"	.40	.35

TERMS:

Mail orders promptly filled—all prices F.O.B. Boston, Mass. Send M.O. or check. Shipping charges sent C.O.D. Minimum order \$5.00. 25% deposit required with all orders.

SEND FOR OUR CATALOGUE NOW!

Inquiries from Dealers, Schools and Industrial Firms Invited

COMET ELECTRONIC SALES CO.

24 Tremont St. Tel. Capitol 7-1594 Boston 8, Mass.

COAXIAL CABLES AND CONNECTORS

"UHF" COAXIAL CABLE CONNECTORS

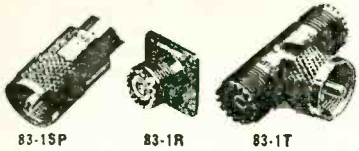

83 SERIES

No.	An. No.	Description	Price
83-15P	(PL259)	Plug	ea. 22¢
83-15PN	(PL259A)	Plug	ea. 22¢
83-168	(UG176U)	Reducing adapter for RG 29, 55 and 58U. Use with 83-15P or 83-15PN	ea. 12¢
83-1R	(S0239)	Receptacle	ea. 28¢
83-1AP	(M359)	Angle Plug adapter	ea. 22¢
83-1T	(M358)	Connector	ea. \$1.12
83-22R	(UG103U)	Receptacle	ea. 35¢
83-22SP	(UG102U)	Plug	ea. 35¢

Minimum Quantity — 100 of a type

COAXIAL CABLES



RG5U	per 1000 ft.	\$70.00
RG6U	per 1000 ft.	70.00
RG7U	per 1000 ft.	120.00
RG8U	per 1000 ft.	40.00
RG9U	per 1000 ft.	135.00
RG10U	per 1000 ft.	90.00
RG11U	per 1000 ft.	100.00
RG12U	per 1000 ft.	175.00
RG13U	per 1000 ft.	125.00
RG18U	per 1000 ft.	320.00
RG22U	per 1000 ft.	120.00
RG29U	per 1000 ft.	37.50
RG34U	per 1000 ft.	175.00
RG39U	per 1000 ft.	55.00
RG54A/U	per 1000 ft.	60.00
RG54U	per 1000 ft.	65.00
RG57U	per 1000 ft.	75.00
RG58U	per 1000 ft.	59.00
RG59U	per 1000 ft.	45.00
RG62U	per 1000 ft.	50.00
RG71U	per 1000 ft.	120.00

Prices based on a minimum quantity of 500 ft.

UG TYPE CONNECTORS

Deduct 10% from prices shown on quantities of 100 or more of any type

AN #	Price ea.	AN #	Price ea.
UG-9/U	1.14	UG-97/U	3.50
UG-10/U	1.56	UG-98/U	1.55
UG-11/U	1.45	UG-100/U	2.34
UG-12/U	1.14	UG-101/U	2.95
UG-13/U	1.56	UG-106/U	.45
UG-14/U	1.45	UG-107/U	2.25
UG-15/U	1.14	UG-108/U	1.75
UG-16/U	1.56	UG-109/U	1.75
UG-17/U	1.45	UG-114/U	1.50
UG-18/U	1.25	UG-115/U	1.35
UG-18A/U	1.05	CW-122/U	.45
UG-18B/U	.99	UG-155/U	.40
UG-19/U	1.28	UG-154/U	3.75
UG-19A/U	1.38	UG-155/U	3.75
UG-19B/U	1.45	UG-156/U	4.25
UG-20/U	1.17	UG-160/U	1.90
UG-20A/U	1.26	UG-160A/U	1.55
UG-20B/U	1.41	UG-167/U	2.25
UG-21/U	.99	UG-173/U	.30
UG-21A/U	1.05	UG-175/U	.15
UG-21/U	.99	UG-176/U	.15
UG-22/U	1.08	UG-188/U	1.30
UG-22A/U	1.38	UG-201/U	1.22
UG-22B/U	1.34	UG-202/U	2.75
UG-23/U	.99	UG-208/U	1.02
UG-23A/U	1.26	UG-208/U	28.50
UG-23B/U	1.29	UG-212/U	4.50
UG-27A/U	2.25	UG-213/U	4.50
UG-28/U	2.34	UG-215/U	3.35
UG-29/U	1.22	UG-216/U	8.70
UG-30/U	1.75	UG-213/U	3.10
UG-35/U	30.00	UG-218/U	6.50
UG-34/U	35.00	UG-222/U	35.00
UG-35A/U	28.00	UG-231/U	2.00
UG-36/U	35.00	UG-236/U	11.75
UG-37/U	28.00	UG-241/U	2.20
UG-37A/U	30.00	UG-242/U	2.50
UG-37/U	.99	UG-243/U	2.75
UG-38/U	.63	UG-244/U	2.50
UG-39/U	2.75	UG-245/U	1.25
UG-59A/U	1.70	UG-246/U	1.45
UG-60/U	1.90	UG-252/U	4.50
UG-60A/U	1.30	UG-254/U	1.82
UG-61/U	2.05	UG-255/U	1.85
UG-61A/U	1.80	UG-260/U	1.12
UG-62/U	28.00	UG-261/U	.95
UG-63/U	1.50	UG-262/U	1.05
UG-65/U	1.65	UG-269/U	2.60
UG-66/U	1.69	UG-273/U	1.50
UG-67/U	1.40	UG-274/U	1.98
UG-68/U	1.17	PL-274	1.12
UG-69/U	.95	UG-290/U	.85
UG-90/U	1.05	UG-291/U	1.05
UG-91/U	1.25	UG-306/U	2.03
UG-91A/U	1.05	UG-333/U	4.70
UG-92/U	1.10	UG-334/U	5.75
UG-92A/U	1.35	UG-352/U	6.00
UG-93/U	1.25	UG-387/U	5.25
UG-93A/U	1.45	UG-270/U	6.50
UG-94/U	1.25	UG-259/U	4.10
UG-94A/U	1.05	UG-279/U	2.40
UG-95/U	1.10	UG-157/U	4.25
UG-95A/U	1.35	MX-195/U	.55
UG-96/U	1.25	UG-197/U	5.25
UG-96A/U	1.45	UG-23/U	28.50

PRECISION CAPACITORS

Standard Brand

D-166602 Oil	18 mfd 800 WVDC	\$2.95
289A Oil	7 mfd 500 WVDC	\$1.95
D-162003 Oil	4 mfd 500 WVDC	\$1.35
231A Paper	3 mfd 250 WVDC	\$.95
D-162031 Paper	2 mfd 550 WVDC	\$.95
D-170908 Paper	.152 mfd 300 WVAC	\$.95

TELEGRAPH V.F.

BAND PASS FILTERS W.E.

D-162235 Mid band freq	935 cps	.15
D-162240 Mid band freq	1955 cps	.15
D-164911 Mid band freq	2125 cps	.15
D-164912 Mid band freq	2295 cps	.15

Above filters \$35.00 each

SPECIALS

W.E. 2' P2AA cord with 2 No. 241A	
W.E. twin plugs	\$4.95
McElroy SR900 Signal Recorder (used)	\$10.00
Jones 4-141 Terminal Strips, per C.	\$9.50
Lord Shock Mounting #200P45, per C.	\$9.50

Write for Quantity Prices
No Orders Less Than \$5.00 Accepted

RAILWAY COMMUNICATIONS, Inc.

P. O. Box 1783 Phone 2-6487
Lincoln, Nebraska

A/N Connectors

We have a large selection of war surplus A/N Connectors of Standard line manufacture. Our catalog will be furnished to Industrials, Manufacturers and Laboratories upon request.

MARCO ELECTRONICS, INC.

513A W. Franklin Street
Balto. 1—Md. Lex. 0198

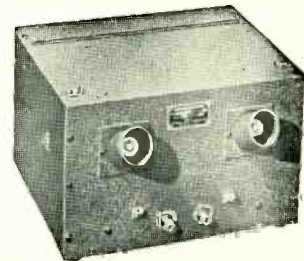

BOONTON 120A VHF CIRCUIT CHECKER

This instrument was developed by the Boonton Radio Corp. to permit checking at VHF: Capacitance, Inductance and complete Resonant Circuits. Ideal for Television and FM Tuners, Quality control, etc. Three Frequency Ranges. Available for immediate delivery.

Catalog price is \$320.00—Our price is \$150.00 f.o.b. N.Y.C. Reconditioned, in good operating condition, subject to prior sale.

THE NATIONAL INSTRUMENT CO.
FAR ROCKAWAY, N. Y.

LIFE ELECTRONIC SALES

91 Gold St., N. Y. 7, N. Y.
Tel: DI gby 9-4154

ELECTRONIC SPECIALS

RA-34 power supplies—0-1000V-350MA-12V-2A-DC-12V-14A-AC\$95.00

RA-38 power supplies—0-15000V-500MA\$275.00

RA-58 power supplies—0-15000V-35MA\$140.00

Switches for above—15000V-1.5Amp. Oil filled—110VAC\$42.50

Relays—6VDC-5PST & 5PDT-120 ohms-2200 turns\$1.25

Relays—Sensitive-8000 ohms-SPDT-Silver contacts\$1.75

Relays—Aircraft Radio Antennae—24VDC SPDT—Silver contacts\$.95

Relays—Allied Control—DPDT-24VDC-.079-Type BJ\$.95

Condensers—Standard Brand-D168574-16 MFD-120VAC 400 Cy-400VDC\$2.75

SCR-296—Basic Components, Complete Parts, Stock Plumbing, etc.

DAK—Direction Finders—complete—Cables, etc.\$375.00

Phone cord extensions—10 ft. with PL55 & JK26\$.60

Tuning units—GP "A"—(Contains several HV micas.)\$1.50

LABORATORY SPECIAL—WE K58801 Precision Potentiometer—110VAC motor drive with selsyn.\$37.50

MANUFACTURERS SPECIAL—10,000 TE5 high Frequency triodes, good up to 750 mc, JAN inspected. For the lot at, each\$.28

Transformers—3000 items of transformers in stock.

Test equipment—Over a thousand items in stock of practically every type. Let us know of your needs. We specialize in hard to get electronics.

MONEY BACK GUARANTEE ON DEFECTIVE MATERIAL SUBJECT TO PRIOR SALE

VETERANS SALVAGE CO., INC.

9 Kulik St.

Passaic—3-6370

Clifton, N. J.



1N23 Crystal Diodes

10c Ea.

Limit 3 To a Customer

ELECTROLYTIC CONDENSERS

2 X 4500 Mfd. 2 V.....	.55
2 X 3000 Mfd. 3 V.....	.75
2 X 1250 Mfd. 10 V.....	.75
600 Mfd. 25 V.....	.45
2 X 500 Mfd. 25 V.....	.75
2 X 3500 Mfd. 25 V.....	.90
25 Mfd. 50 V.....	.35
100 Mfd. 50 V.....	.45
50 Mfd. 100 V.....	.45
2 X 40 Mfd. 150 V.....	.45
500 Mfd. 200 V.....	.95
30 Mfd. 450 V.....	.35
2 X 8 Mfd. 475 V.....	.60
2 X 19 Mfd. 575 V.....	.90

OIL FILLED CONDENSERS

2 X 5 Mfd. 400 VDC.....	.30
.1 Mfd. 400 VDC.....	.20
2 X .25 Mfd. 600 VDC.....	.35
2 Mfd. 600 VDC.....	.35
5 Mfd. 600 VDC.....	.70
3 X 4 Mfd. 600 VDC.....	1.45
4 X 3 Mfd. 600 VDC.....	1.45
7 Mfd. 600 VDC.....	.75
2 X 8 Mfd. 600 VDC.....	1.45
2 X 4 Mfd. 1000 VDC.....	1.75
2 Mfd. 1000 VDC.....	.70
.4 Mfd. 2000 VDC.....	.95
4 Mfd. 4000 VDC.....	7.95
.1 Mfd. 7500 VDC.....	1.25
.25 Mfd. 20 KVDC.....	19.95
.08 Mfd. 12.5 KVDC.....	9.95

VARIABLE CONDENSERS

(Maximum Ratings Per Section)

Single Sec. 18 Mmfd. 5000 V.....	—
Dual Sec. 25 Mmfd. 3000 V.....	—
Single Sec. 35 Mmfd. 2000 V.....	—
Dual Sec. 100 Mmfd. 3000 V.....	—
Single Sec. 135 Mmfd. 3500 V.....	—
Single Sec. 150 Mmfd. 13000 V.....	—
Dual Sec. 200 Mmfd. 2000 V.....	—
Dual Sec. 250 Mmfd. 3000 V.....	—
Bud.....	1.75
Johnson.....	1.45
Hammerlund.....	.69
Johnson.....	3.45
Cardwell.....	1.75
Bud.....	9.95
Bud.....	3.75
Bud.....	4.95

MICA CONDENSERS

.0001 Mfd. 600 VDCW.....	.95
.005 Mfd. 600 VDCW.....	.25
.4 Mfd. 600 VDCW.....	1.45
.0001 Mfd. 5000 VDCW.....	.75
.0004 Mfd. 5000 VDCW.....	.75
.005 Mfd. 5000 VDCW.....	.75

MISCELLANEOUS

300 Ohm Twin Lead..... per ft.	\$.025
73 Ohm Coax Cable RG59/U..... per ft.	.055
Swinging Choke 9-36 H. @ .75/.075	
A.....	14.95
Relay 115 VAC DPDT—30 Amp. Contacts	3.25
100 Insulated Resistors—1/2 & 1 W. Asst'd.	1.45
110 V. Line Filter 2 Amp.....	.35
Blocking Oscillator Transformer (Wemco).....	.45
Hookup Wire—Asst'd. Lengths & Colors W/Tinned Ends. Approx. 500 Ft.	1.45
4AG Fuse Extractor Post (Ideal Crystal Diode Holder).....	.15
Pulse Transformer (300 K.V.).....	14.95
Power Transformer (800/2400 Cps. For Scope).....	2.75
Marker Coils (Slug Tuned—82; 1.64; 4.1 and 16.4 Kc.).....	1.25
Reactor (200 Henries @ 10 Ma.).....	2.50
Reactor (2000 Henries @ 0 Amp.).....	2.50
Reactor (19000 Henries @ 0 Amp.).....	2.50
Transformer (7670 V. @ 483 Ma.) 22 KV Test.....	39.95

Discounts to Quantity Buyers

Min. Mail Order \$2.00—

25% Dep. With Order Baf. COD

Write Your Needs

MARCO ELECTRONICS, INC.

513-515 W. Franklin St., Baltimore 1, Md.

Phone—Lexington 0198

10 Cm OSCILLATOR BC-1096-B with 30 mc pre IF amplifier 1078 B, klystron power supply and 417-A klystron, 110 v, 60 cps, new in transit-case, p/o SCR 584\$125.00

10 Cm TEST LOAD TPS-55 PB/T. \$5.00

10 Cm TUNABLE REFERENCE CAVITY, with 1N27 crystal and holder, type N Fitting\$15.00

CALIBRATED S BAND FIXED ATTENUATOR, type N fittings.....\$10.00

S BAND RECEIVER TRANSMITTER RT-72/UPN-1, less tubes, for battery operation\$100.00

X BAND VSWR TEST SET TS-12/AP, complete with linear amplifier, direct reading VSWR meter, slotted wave guide with gear driven traveling probe, matched termination and various adapters, with carrying case, new.

X BAND PICK-UP HORN AT-48/UP, with coaxial fitting\$5.00

X BAND POWER METER TS-36/AP, new\$125.00

X BAND WAVE METER TS-33/AP, new\$125.00

X BAND POWER LOAD TS-108/AP, new\$25.00

MICROWAVE TEST CABLE, 15' RG-9U cable with UG-24U connectors. 15 feet long\$4.00 8 feet long.....\$3.50

LOSSY CABLE, 10 db at 3300 megacycles, type N connectors.....\$3.00

TYPE N CONNECTORS AND ADAPTERS, UG-10, 12, 21, 22, 24, 25, 27, 29, 30, 58, 59, 83, 86, 167, 190, 201, 245 and UHF Connectors SO-239, PL-259, 83, 1AP, UG-266, complete with center contacts, immediate delivery.

RADAR JAMMER, T-26/APT-2, 435-715 megacycles, 110 volts, 400 cps, new, complete with antenna.....\$40.00

SD-3 SHIPBOARD RADAR EQUIPMENT, complete with all accessories, operates on 115 volts, 60 cps, new.

SA-1 RADAR TRANSMITTER, Receiver and Indicator, 115 volts, 60 cps, new.

RADAR RECEIVER BC 1068-A, 150-200 megacycles, individual tuning for the r.f. stages, band widths 4 megacycles, 115 volts, 60 cps, 14 tubes.....\$45.00

GENERAL RADIO PRECISION WAVE-METER, type 724A, range 16 kc to 50 megacycles, 0.25% accuracy, V.T.V.M. resonance indicator, complete with accessories and carrying case, new.....\$175.00

125/APR ANTENNA.....\$5.00

TS 10/AP for APN-1.....\$40.00

TS 102/AP CALIBRATOR.....\$75.00

TS 203/AP CALIBRATED SELSYN.....\$13.00

TEST SET I-178 CALIBRATOR.....\$75.00

TEST SET IE-21-A, for SCR-518A.....\$75.00

TEST SET IE-19-A, for SCR-522.....\$175.00

TELEPHONE TEST SET EE-65-F.....\$30.00

SYNCHRONIZER W.E. BC1043B.....\$75.00

SYNCHRONIZER W.E. BC1155-A.....\$50.00

MODULATOR W.E. BC748-A, 10 kw, 1.3 microseconds, 750-850 PPS, new, less tubes\$25.00

TRANSMITTER RECEIVER BC800M, new\$30.00

MODULATOR BC 1007-A.....\$75.00

RECTIFIER-POWER UNIT, 110 v, 400 cps, PP-4/APQ-2\$15.00

HI VOLTAGE SUPPLY, RA-90-A, 110 v, 400 cps.....\$10.00

GO-9 TRANSMITTER, less tubes.....\$100.00

TRANSMITTER BC-AR-230, new, less coils\$5.00

W.E. NETWORKS, D-162630, D-162629, D-161637, D-162634.....\$1.00 each.

G.E. DELAY LINE, 4 microseconds 1000 ohms, 0-2 mc\$4.00

TRANSFORMERS, 115 volts, 60 cps primaries:
1. 6250, 3250 and 2000 volts, tapped primary\$14.00
2. 6250 volts 80 ma, ungrounded, G.E.\$12.00
3. 2 secondaries at 500 volts 5 amps each, wt 210 pounds.....\$50.00

PULSE INPUT TRANSFORMER, permalloy core, 50 to 4000 kc impedance ratio 120 to 2350 ohms.....\$3.00

PULSE TRANSFORMER, Utah 9280.....\$1.50

VARISTORS WE D171528, D171628, D161871-A......75c each.

0-350 volts, 1000 ohms per volt meter, Westinghouse NX-35.....\$4.50

ELECTRO IMPULSE LABORATORY

66 Mechanic St.,

Red Bank, N. J.

Red Bank 6-4247

MARINE EQUIPMENT—NAVAL & COMMERCIAL

Partial Listing

ET-8023D1—200 watts ship transmitter, 2.0-24.0 mcs. Mfd by Radiomarine Corp. of America. NEW in original cases w/ installation material and set of spare tubes.

136A—Mackay ship transmitter, 40 watts cw, 5.5-22 mcs. Supplied complete w/110 V dc motor generator and spares for both m/g and XMTR. NEW, export packed, \$115 per set.

ET-4332B—RCA 250 watts radio telephone, 350 watts cw, 2.0-20.0 mcs. Operates from 110 AC. Condition: EXCELLENT, One only at \$825.00.

INSULATORS—Standoffs, Feedthru's and Strains. We have tens of thousands in stock. Please advise size and quantity desired.

TBK—500 watts cw Navy transmitter, 2.0-20.0 mcs

TAJ—500 watts cw Navy transmitter, 150-550 kcs

TBI—350 watts cw, 50 watts phone, 175-600 kcs and 2.0-18.1 mcs.

Each of the above supplied with 115 or 230 vdc motor generator and magnetic controller. TBL has speech input eqpt. Condition: EXCELLENT.

Underwater Sound Beacons—Model NAA. Consists of a buoy-shaped water-tight, welded container fitted with omnidirectional electrosonic transducer. Inside are batteries, oscillator-amplifier, vibrator power supply, timer and self-destroying device, which can be removed if desired. Beacon emits 5 watts audio at 10 to 20 kcs at chosen code for 48 hours. NEW, original packing.

SPECIAL INTRODUCTORY OFFER—12 in. standoffs w/brass or bronze base and cap at \$1.00 each.

AIRCRAFT EQUIPMENT

Partial Listing

ASB-5—515 Mcs. Airborne Radar. Complete Brand New early search and homing sets, including transmitter, indicator switching unit, rectifier power unit, control unit, etc. Mfr. Bendix.

Z A—Blind Landing Eqpt. 90-100 Mcs., complete, new with test oscillators and spares for same.

GP-7 transmitter complete w/6 plug-in tuning units covering range of 350-9050 kcs, emission A₁, A₂, A₃. 85-125 watts. Mfr. Westinghouse. Condition: Brand New.

MN-26—Bendix Radio Compasses—Complete, new.

APS-4—Junction boxes, J-84. Brand new in original packing.

TEST SETS

TS-263A/TPS-10—Complete, portable f.m. field test set used to check radar in band 8990-9170 Mcs.

Power Requirements: 60 watts at 115 V, 50 to 1200 cps.
Power Output to Waveguide: 5 decibels above 1 milliwatt, max.
Power Output to Coaxial Cable: 4 decibels above 1 milliwatt, max.
Price: \$545.00.

This set is new, complete in one portable unit and ready for use. No permanent or special installation procedures are necessary. Quantity: Very limited.

METER MULTIPLIERS — PRECISION RESISTORS. 20,000 volts, 20 megohms. Accuracy ± 0.5%. New, in original packing. Standard Brands. Manufacturer's current list is more than \$240.00! Our price: \$12.00

TDY Radar jammer — Power Oscillator only; 110 V AC, 60 c. Brand new, less tubes at \$95.00 ea.

TYPE O—Reversible magnetic starters, 1 to 2 hp., 110, 220, 440 V. AC. Mfr. Westinghouse.

We carry an extensive stock of marine and aircraft electronic accessories
Your requests for quotations are invited

All material is offered subject to prior sale, f.o.b. our warehouse. Terms: Cash

COMPASS COMMUNICATIONS CO.

37 Montgomery Street Phone: Delaware 2-4656 Jersey City 2, N. J.

SIGNAL GENERATORS

GENERAL RADIO	805-A
FERRIS	16-C
FERRIS	18-B
MEASUREMENTS	65-B
BOONTON	155-A
BOONTON	140-A

IMMEDIATE DELIVERY - RECONDITIONED
GUARANTEED

Subject to Prior Sale, F.O.B., N. Y. C.

THE NATIONAL INSTRUMENT COMPANY

FAR ROCKAWAY NEW YORK

TUBES

(No Government Surplus)
Made by one of the nationally known, first-line tube manufacturers, each and every tube is new, individually tested, boxed, and carries the standard RMA guarantee. Your money back if not completely satisfied.

1R5	6SA7GT	12SA7GT	
1S5	6SJ7GT	12SJ7GT	Any
1T4	6SK7GT	12SK7GT	Type
3S4	6SO7GT	12SO7GT	
6AT6	6V6GT	35L6GT	36¢
6BA6	6X5GT	35W4	
6BE6	12AT6	35Z5GT	each
6K5GT	12BA6	50B5	
6K6GT	12BE6	50L6GT	

Minimum order \$3. 20% with order, bal. C.O.D.
Write Dept. 4011 for FREE CATALOG.
Store open daily 9 to 6, Sat. 9 to 5.

RADIONIC EQUIPMENT CO.

170 Nassau Street, New York 7, N. Y.
Opp. City Hall; Near B'klyn Bridge

Special Values

D. C. MICROAMMETERS

0-100 ua. 4" sq. G.E. DO 58	\$12.00
same with "Volt-Ohm-M.A." scale	12.00
0-100 ua. 2 1/2" Gruen	4.00
0-100 ua. 4 1/2" round Weston 643	12.00
0-200 ua. 4 1/2" round Weston 643	10.00

R. F. MILLIAMMETERS

0-100 Ma. 3 1/2" Weston 425	\$ 9.00
0-120 Ma. 2 1/2" Weston 507	7.00
0-10 Ma. 4 1/2" Weston (vacuum)	22.00

SHUNTS

150 or 240 Amps-50 Mv-aircraft type \$1.00

PRECISION ELECTRICAL INSTRUMENT CO.
146 Grand Street New York 13, N. Y.

ALLIS-CHALMERS

MOTOR GENERATORS U. S. Navy specifications



1.88 KVA—1.5 KW—8 PF
Input—115 VDC—20 Amps
Output—120 VAC—15.65 Amps
Single phase—60 cycle
Allis Chalmers Motor—2.2 HP—3600 RPM
Centrifugal Starter
Ward Leonard Speed Regulator

Price \$175.00—Gov't Cost \$1028.94

COMPLETE WITH SPARES • EXPORT PACKED IN ORIGINAL CASES

SHIPS & POWER EQUIPMENT CORPORATION

829 Newark Avenue Elizabeth 2-6925 Elizabeth, New Jersey



SPEED REGULATOR

1.25 KVA—1 KW—8 PF
Input—115 VDC—14 Amps
Output—120 VAC—14.4 Amps
Single phase—60 cycle
Allis Chalmers Motor—1.93 HP 3600 RPM
Centrifugal Starter

Price \$90.00—Gov't Cost \$439.52

SHEET METAL MACHINERY

NEW and Used — Brokes — Shears —
Forming Rolls — Folders — Punches —
Di-Acro, Pexto, Niagara & Whitney Equip-
ment.

R. D. BROOKS CO., INC.
Han. 5226
361 Atlantic Ave., Boston, Mass.

ART-13 POWER SUPPLIES AND LOW FREQUENCY OSCILLATORS

High Power R.F. Amplifiers, Special Equipment.
Quotations on request.

SPECTRA PRODUCTS

155 Chambers St. New York 7, N. Y.

VILLAGE RADIO EQUIPMENT CO.

Announces a New Service
THE TEST EQUIPMENT EXCHANGE

PURCHASING AGENTS: Do you require an item of TEST EQUIPMENT presently unavailable? Do you have equipment surplus to your present operations? LIST YOUR REQUIREMENTS and SURPLUS with us to effect an advantageous exchange or purchase.

Write for Full Details

VILLAGE RADIO EQUIPMENT CO.

201 West 16 St., New York 11, N. Y.

TELEVISION CAMERAS

Available for immediate delivery.

DUMONT Type 5027-A IMAGE ORTHONIC PICKUP HEADS, with type 5047-A ELECTRONIC VIEW FINDERS, complete with all tubes,—including 2P23 Image Orthonics, EKTAR 90 MM. f 3.5 Lens

Factory Reconditioned—Perfect Condition
f.o.b. N.Y.C. Subject to prior sale

WRITE FOR COMPLETE INFORMATION

THE NATIONAL INSTRUMENT COMPANY

FAR ROCKAWAY NEW YORK

**COMMUNICATION DEVICES CO.
offers
CLEAN ELECTRONIC SURPLUS!**

**The Versatile U. S. Navy
TDE Transmitter**

An all-band (300-18,100 kcs) two section transmitter in one steel cabinet complete with tubes and M.G. with outputs of 125 watts A-1, A-2; 35 watts 'phone. In 115 or 230 Volt DC models. Tested, clean, and complete.

RADIOTELEPHONES—

SCR-281 (BC-441-Hallcrafters) for 110 V. A.C. xtal controlled, 25 watt unit with all tubes, speaker, hand telephone and mtg. Less crystals, excellent condition, each\$169.50

MQ (Mfgd by R.C.A.) for small craft. Five watts output, uses 6/12 Volt DC source, range 2-3.5 Mc, w/speaker, remote hand telephone, tubes, less xtals, NEW, each\$100.00

F.M. Point-To-Point RADIO LINK

Our large stocks of **SCR-528** (20.0-27.9 Mc) transmitters and receivers are complete with all components and accessories export packed for immediate delivery, weight 163 lbs. Write for our bulletin describing its minute completeness!

RECEIVERS—

Wilcox 602-A, xtal, fixed freq, 110 V. A.C. receiver for VHF (30-160 Mc) airline monitoring. NEW w/tubes, less xtals, each\$39.50

Wilcox CW-3, xtal, fixed freq, 110 V. A.C. for medium freqs. with tubes, manual, 1 set of coils, less xtals. NEW, each\$29.50

WIIP ANTENNAS — AN-131-A, as threaded base, 10'6" long, folds into 8 interconnected sections for stowing. NEW, each\$1.49

OTHER ITEMS—Bludworth, R.C.A. direction finders complete; 220/110 step-down transformers all ratings; vibrapacks.

Complete walkie-talkies, Model MAB

Offerings subject to prior sale.

Catalog sent on request.

COMMUNICATION DEVICES CO.

2231 Twelfth Avenue at 133rd St.
New York 27, N. Y.

Cable: Communidev Tel: WA-6-6606, 7

Industrial Power Supply Equipment

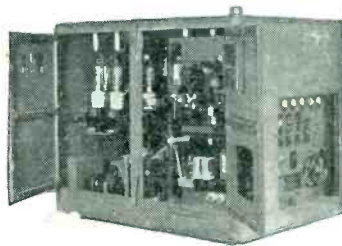

**NEW RA38
POWER SUPPLIES**

115V., 60 cyc. input adjustable output 0.15-1000V. A.C. or D.C. @ 500 Mils. Complete with extra set of new tubes and remote control. Shipping weight 2100 lbs. **\$250.00**

**RECTIFIERS — Dry Disc Type—
Continuous Duty Ratings**

- 3.5V. A.C. 1.8V. D.C. 1.0 Amps Full Wave Bridge 90
- 6.5V. A.C.—2.2 V. D.C. @ 3.0 Amps Full Wave Center Tap 1.20
- 36V. A.C. 200 Mil D.C. H.W 75
- 36V. A.C. 2.2 Amps. D.C. Full Wave Bridge 3.75
- 54V. A.C.—1.6 Amps. D.C. G.E. Full Wave Bridge 4.40
- 154V. A.C.—600 Mil D.C. Full Wave Bridge 6.85
- 180V. A.C.—400 M.A. D.C. G.E. Full Wave Bridge 6.90

CONDENSERS

- 500 Mfd 200V dry Electrolytic 95
- 2 Mfd 600V Tubular Oil 39
- 10 Mfd 600V Oil 95
- 2 Mfd 2500V Oil 2.40
- 2 Mfd 3000 Oil 2.75
- .25/.25 6000V D.C. or .125 Mfd—12000V D.C. Oil 3.75
- 1.0 Mfd 25 KV 36.00
- .001/25 KV Mica 25.00
- 50 MMF 32 KV Tubular vacuum 4.95

RELAY

RC-117—Westinghouse Time Delay Current Relay, Type SC-M .2 to 1 amp A.C. or D.C. .8 amp continuous rating. Rating 20-40% drop out ratio. Net Wt. 3 lbs. Dim. 3" W x 5" D x 5 3/8" H 12.9'

TRANSFORMERS



T-103—Voltage regulator Transtat, American Transformer Co. Spec. 29145 Max KVA output 11.5 50/60 cyc. 0.115V. 100 amps. or 230 V. 50 amps. **\$75.00**

Net Wt. 134 lbs. Dim. 26" W x 16" D x 17 1/2" H (Encl. 8" shaft ext.)

T-102—Filament Transformer, American Transformer Co. Spec. 29106, Type WS .050 KVA, 50/60 cyc. Single phase, 35 KVA test, 12 KV D.C. operating. Primary 115 V., secondary 5 V., 10 amps with integral standoff insulator and socket for 250T, 371, 872 5563, etc rectifier tubes **\$12.50**



Net Wt. 15 1/2 lbs. Dim. 6 1/2" W x 6" D x 12" H.O.A.

METERS

Weston Model 476-3" A.C. Ammeter, 3 Amps. full scale, Calibrated 0.120 Amps. with 40/1 current trans\$8.50
Net wt. 3 pounds

M-143 A.B. Weston Kilovoltmeter-3". Model 301, 20 KV. @ 1000 ohms per volt, flush type calibrated for steel panel mountings with 20 meg. 20 KV Weston resistor complete with clips and standoff insulators \$18.00
Net wt. 4 pounds.

Multimeter, Supreme model 543-S **\$12.95**
R. F. ammeter Weston 425-0-3 amps **\$5.95**

TRANSTATS

- 115 V. 50/60 cycle input 103-126 V. output @ 2.17 amps \$9.50
- 115/230 V. 50/60 cycle input 0.260 V. output @ 2 1/2 amps \$21.50
- GR Variac, 115 volts 50/60 cycle input 0.135 V output @ 5 amps cased. \$14.50
- 115 V. 50/60 cycle input, 0.135 V. output @ 10 amps \$24.50

THERMOSTAT SWITCH

Fenwall —50°-400° F. 110-220 V. 2500 watt contacts, adjustable. \$1.60
KV Meter Multiplier resistor 1 meg 1/10% noninductive Wire Wound. \$1.25

TUBES

TRANSMITTING	THYRATRONS	RECTIFIERS
RK75/307A 4.50	2D21 Min. 1.25	FG32 4.00
450TH/6C21 22.50	3C23 4.75	371B 5.95
750TL 47.50	FG81A 4.75	531 18.00
WL533 750W U.H.F. 17.50	C6A 8.50	872 1.75
Triode 17.50	C6J 9.50	3B22 2.95
714AY Magnetron 9.50	931A Photo-Multiplier 2.75	4B28/289414 6 Amp. Rectigon 3.95
730A Magnetron 10.75	All Tubes New, Boxed and of Standard Mfg.	

MOTOR GENERATORS

G.E. Type CC-21991 Input 115 volts D.C., @ 5.7 amps. Output 115 V. A.C. 60 cycle, single phase 350 V.A. @ 85% \$58.00

G.E. Type CC-21990 Input 32 V. D.C. @ 22 amps. Output 115 V. A.C. 60 cycle, single phase, 350 V.A. @ 85% P.F. \$63.00

Leland Type CLL-21985 Input 115 V. D.C. @ 4.2 amps. Output 115 V. A.C. 60 cycle, single phase, 240 V.A. @ 86% P.F. \$47.00

WESTINGHOUSE—Type "AB"

De-ion circuit breakers
Thermal trip—without enclosure 3 pole—50 amp frame size
Style 545-389 D 15 amp rating 9.50 ea.
Style 545-391 D 25 amp rating 9.50 ea.
Style 545-393 D 50 amp rating 9.50 ea.

HEATERS

H-149—Chromolox strip heaters, 300 W., 115 V. (1/4x1 1/2x12") \$1.00

All merchandise in "as new" condition. Add approximately 20% to net weights for estimated shipping weights. Terms are 30% with order, balance C.O.D. All prices f.o.b. Los Angeles Warehouse. Write for additional detailed information on any of the above items and for special quality discounts.

1527 E.
Seventh Street



Los Angeles
21, California



MAGNETRONS

In Quantities

2j31	12.-
714AY	6.-
725A	12.-
730A	6.-
ask us if you need others	
KLYSTRONS	
723a/b	6.95
2K25	18.-
707B	6.95
2K28	15.-
PULSE MODULATORS	
715B	9.-
5D21	18.-
701A	6.-

STAR ELECTRONICS CORP.

135 Liberty St.
New York 6 Phone Worth 7-8262

8-DRAWER EQUIPTO STEEL SHOP CABINET



NOW IN STOCK!

Despite current steel shortages, we have a limited quantity of these remarkably useful cabinets in stock NOW. Contains 8 drawers, each with 4 compartments. Overall: 25 1/2" wide, 10" high, 12" deep. Olive green baked enamel finish. Can be stacked up to six high. Your Cost, each

\$14.95

Please include 25% deposit with order. Balance C.O.D. Dept E-11

FEDERATED PURCHASER Inc.
NEW YORK CITY ALLENTOWN, PA.
80 Park Place 1115 Hamilton St.,
D1gby 9-3050 Allentown 3-7441

LEGAL NOTICE

STATEMENT OF THE OWNERSHIP, MANAGEMENT, CIRCULATION, ETC., REQUIRED BY THE ACT OF CONGRESS OF AUGUST 24, 1912, AS AMENDED BY THE ACTS OF MARCH 3, 1933, AND JULY 2, 1946

Of Electronics, published monthly at Albany, N. Y., for October 1, 1948.

State of New York) ss.
County of New York)
Before me, a Notary Public in and for the State and county aforesaid, personally appeared J. A. Gerardi, who, having been duly sworn according to law, deposes and says that he is the Secretary of the McGraw-Hill Publishing Company, Inc., publisher of Electronics, and that the following is, to the best of his knowledge and belief, a true statement of the ownership, management, etc., of the aforesaid publication for the date shown in the above caption, required by the Act of August 24, 1912, as amended by the Acts of March 3, 1933, and July 2, 1946 (section 537, Postal Laws and Regulations), printed on the reverse of Form 3526, to wit:

1. That the name and address of the publisher, editor, managing editor and business manager is: Publisher, McGraw-Hill Publishing Company, Inc.; Editor, Donald G. Fink, Managing Editor, W. W. MacDonald; Business Manager, Wallace B. Blood, all of 330 West 42nd St., New York 18, N. Y.

2. That the owner is: McGraw-Hill Publishing Company, Inc., 330 West 42nd Street, New York 18, N. Y. Stockholders holding 1% or more of stock: Curtis W. McGraw, Executor of the Will of James H. McGraw, 330 West 42nd Street, New York 18, N. Y.; James H. McGraw, Jr., 330 West 42nd Street, New York 18, N. Y.; James H. McGraw, Sr., 330 West 42nd Street, New York 18, N. Y.; T. Chevalier, Trustees for: Harold W. McGraw, James H. McGraw, Jr., Donald C. McGraw and Curtis W. McGraw, all of 330 West 42nd Street, New York City; Edwin S. Wilsey and Curtis W. McGraw, Trustees for James H. McGraw, 3rd, Madison, New Jersey; Curtis W. McGraw, Donald C. McGraw, both of 330 West 42nd Street, New York City; Mildred W. McGraw, Madison, New Jersey; Grace W. Mehren, 538 Arenas St., La Jolla, Calif.; Jacob L. Hain, 1 North 5th Street, Reading, Pa.

3. That the known bondholders, mortgagees, and other security holders owning or holding 1 per cent or more of total amount of bonds, mortgages, or other securities are: None.

4. That the two paragraphs next above, giving the names of the owners, stockholders, and security holders, if any, contain not only the list of stockholders and security holders as they appear upon the books of the company but also, in cases where the stockholder or security holder appears upon the books of the company as trustee or in any other fiduciary relation, the name of the person or corporation for whom such trustee is acting, is given; also that the said two paragraphs contain statements embracing affiant's full knowledge and belief as to the circumstances and conditions under which stockholders and security holders who do not appear upon the books of the company as trustees, hold stock and securities in a capacity other than that of a bona fide owner; and this affiant has no reason to believe that any other person, association, or corporation has any interest direct or indirect in the said stock, bonds, or other securities than as so stated by him.

J. A. GERARDI, Secretary.
McGraw-Hill Publishing Company, Inc.
Sworn to and subscribed before me this 29th day of September, 1948.

[SEAL] ELVA G. MASLIN.
(My commission expires March 30, 1950.)

WANTED

WANTED

W. E. Carrier Telephone and Carrier Telegraph Equipment and components. Filters, repeating Coils, Transformers, Equalizers. Type CF1, CF2, H, C, and other carrier equipment, telephone and telegraph repeaters.

W-6660, Electronics
330 West 42nd St., New York 18, N. Y.

SURPLUS BARGAINS

WESTINGHOUSE HYPERSIL CORE TRANSFORMERS

Pri 115V 60cy. 3/4 KVA. Sec #1-240V # 1.56A, Sec. #2-240V @ 1.56A, Wt. 30 lbs.—\$11.50 ea., 10 @ \$10.00 ea.

Pri 115V 60cy tapped, Sec 5V @ 30A.....\$3.32

ELINCO PM-2 Rate Generator.....\$6.00

EAD J-36 Rate Generator.....\$7.00

FILTER CHOKE—Hermetically sealed 10H at 400

MA DC. 90 ohm res. wt. 11 lbs.....\$3.85

W. E. Sound Powered Hand Set.....\$14.88

W. E. Sound Powered Chest Set.....\$14.88

TUBES AT SENSATIONALLY LOW PRICES

WRITE FOR LATEST BARGAIN BULLETIN

ELECTRONIC RESEARCH LABORATORIES

5832 N. Hegerman St., Philadelphia 24, Pa.

Phone—Cumberland 8-4737

EMPLOYMENT BUSINESS EQUIPMENT

OPPORTUNITIES

Whatever your need—
think "SEARCHLIGHT" FIRST

WANTED

Teletypewriters complete, components or parts. Any quantity and condition.

W-6654, Electronics
330 West 42nd St., New York 18, N. Y.

WANTED

WESTERN ELECTRIC VACUUM TUBES

Types 101F, 102F, 272A, 274A or B, 310A or B, 311A, 313C, 323A, 328A, 329A, 348A, 349A, 352A, 373A, 374A, 393A, 394A, 121A Ballast Lamps.

W-6641, Electronics
330 West 42nd St., New York 18, N. Y.

WANTED

TEST EQUIPMENT

All types of Laboratory Test Equipment, new, used or surplus. Send description to

W-4861, Electronics
330 West 42nd Street, New York 18, N. Y.

WANTED, AIRCRAFT RADIOS

AN/ART-13, BC-348, RTA-1B, AN/APN-9, R5A/ARN-7, AN/ARC-1, AN/ARC-3, SCR-718, BC-783-C, I-152, MN-26-C, Test Sets with TS- or I- prefix. State quantity, condition and best price first letter.

HI-MU ELECTRONICS
BOX 105, NEW HAVEN, CONN.

Use National

CLASSIFIED ADVERTISING

for bringing business needs or opportunities to the attention of men associated in administrative, executive, management, sales and responsible technical, engineering and operating capacities with the industries served by McGraw-Hill publications.

For advertising rates or other information address:
Classified Advertising Division

McGRAW-HILL PUBLISHING CO., Inc.
330 W. 42nd St., New York 18, N. Y.

